

VRF

Technical Data Book

All indoor units for Europe (R410A, 50Hz, HP/HR)

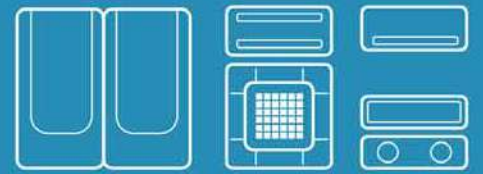

History

Version	Modification	Date	Remark
Ver.1.0	Release VRF DVM S Indoor Unit TDB for Europe	'15.08.31.	
Ver.1.1	Updated heating operation range : HE, HT	'15.10.08.	
Ver.1.2	Modify Electrical wiring diagram of Hydro HE	'15.10.16.	
Ver.1.3	Add page index	'15.10.16.	
Ver.1.4	Modify Capacity & Power input correction of Hydro HE	'15.11.23.	
Ver.1.5	Modify unit of air flow rate in ERV Plus	'16.01.18.	
Ver.1.6	Modification for 'power input' of 1Way Cassette (p.11) - AM022FN1DEH*** : 50 → 40W Modification for 'Dimensional drawing' of Floor Standing (p.227) - AM***FNFDEH*** : Air inlet grille → Air outlet louver	'16.07.27.	
Ver.1.6.1	Add Temperature and air flow distribution data for console. (p.218~222)	'16.10.17.	
Ver.1.7	Add line up - 1Way Cassette : 2 models (5.6/7.1kW) - 360 Cassette : All models (4.5~14kW) - Slim Duct (drain pump included) : All models (1.7~14kW) - MSP Duct (drain pump included) : All models (2.2~16kW) - BORACAY : All models (1.5~7.1kW) - Console : 2 models (2.2/4.5kW) - PAC : All models (14/28kW) Add heat exchanger spec. for all indoor models. Modification for 'Temperature and air flow distribution' data of Big Ceiling. (p.334~335)	'16.11.07.	
Ver.1.8	Add tCO2e data (Hydro Unit HT's Specifications)	'16.12.09.	
Ver.1.9	Add Sound Power data & graph (AM028/036/056, p.338, 348)	'16.12.19.	
Ver.2.0	Modify Fan Characteristics section of Duct model(Slim&MSP duct)	'16.12.22.	
Ver.2.1	Modify Capacity table of Floor standing model (p.372, 373)	'16.12.27.	
Ver.2.2	Modify Pressure drop from heat exchanger of Hydro unit HT. (p.421)	'17.02.06.	
Ver.2.3	Modify Net/Shipping Weight for Slim/MSP/HSP Duct & Duct S Modify Pannel Spec of 4Way Cassette(600x600) (Model name, Net/Shipping Weight&Size)	'17.03.16.	
Ver.2.4	Modify the Dimensional drawing of Hydro unit HT. (p.417) Modify the Flow Rate (l/s) of ERV Plus. (p.388)	'17.03.29.	
Ver.2.5	Add Temperature and air flow distribution data for 4Way CST(600x600). (p.59~61)	'17.07.12.	
Ver.2.51	Modify the Accessory Compatibility table for MCU kit(P15)	'17.09.13.	
Ver.2.6	Modified the Capacity Table & Power input correction factor of Hydro Unit HE (P399~405)	'17.09.26.	
Ver.2.7	Modified 'Electrical wiring diagram' of indoor unit (P.99)	'18.01.05	
Ver.2.8	Modified Floor Standing Piping Conection spec (P374)	'18.01.24	
Ver.2.9	Added new line up (Home Duct, p.248~p.265)	'18.03.28	
Ver.2.9.1	Revised the error of 1Way CST size (p.14, 15, 22)	'18.04.10	
Ver.2.10	Revised the error of HSP Duct power spec (p.225)	'18.07.17	
Ver.3.0	Revised the Fan characteristics (P-Q Curve) of Duct line up	'18.08.03	

History

Version	Modification	Date	Remark
Ver.3.1	Revised the ERV Plus Optional Accessory	'19.03.08	
Ver.3.2	Updated the capacity table	'19.04.26	
Ver.3.21	Updated the Operating range of Hydro unit HE	'19.07.09	
Ver.3.3	Modified the Shipping Weight (AM***KN4DEH/EU)	'19.09.11	
Ver.3.4	Updated the Capacity Table of Hydro units	'20.07.14	
Ver.3.5	Updated the Motor Output spec of ERV Plus	'21.05.20	
Ver.3.6	Updated the Sound Power data of Ceiling	'21.11.17	
Ver.3.7	Modified the NR Curve of Sound Pressure level	'22.09.08	
Ver.3.8	Updated the Specifications & Performance of Hydro Unit(HE/HT)	'22.09.26	
Ver.3.9	Updated the MSP Duct Motor Specification	'23.04.17	

Contents

I. Products

1. Nomenclature	5
2. Line up	6

II. Indoor Units

1. 1Way Cassette	10
2. 2Way Cassette	30
3. 4Way Cassette S(600x600)	38
4. 4Way Cassette S	60
5. 360 Cassette	86
6. Duct S	111
7. Slim Duct	152
8. MSP Duct	195
9. HSP Duct	234
10. Big Duct	250
11. Home Duct	260
12. OAP Duct	276
13. Neo Forte	286
14. AR5000	313
15. BORACAY	341
16. Ceiling	370
17. Big Ceiling	380
18. Console	391
19. Floor Standing	409
20. PAC	417
21. ERV Plus	426
22. Hydro Unit HE	433
22. Hydro Unit HT	448

I. Products

1 Nomenclature

Indoor Units

Model Names

AM	071	K	N	4	D	E	H	/	EU
(1)	(2)	(3)	(4)	(5)	(6)	(7)	(8)		Buyer

(1) Classification

AM	VRF
----	-----

(2) Capacity

x 1/10 kW (3 digits)

(3) Version

F	2013
H	2014
J	2015
K	2016

(4) Product Type

N	Indoor Unit (NASA)
X	Outdoor Unit (NASA)

(5) Product Notation

1	1Way Cassette
2	2Way Cassette
4	4Way Cassette S / 360 Cassette
N	4Way Cassette(600x600)
L	LSP Duct
M	MSP Duct
H	HSP Duct
E	OAP Duct
T	Neo Forte
Q	Neo Forte(EEV)
A	AR5000
V	AR5000(EEV)
C	Ceiling
J	Console
F	Floor Standing
P	PAC
K	ERV Plus
B	Hydro Unit

(6) Feature

F	Flagship
P	Premium
D	Deluxe
S	Standard

(7) Rating Voltage













































































































E	220~240V, 50Hz, 1Φ
K	220~240V, 50/60Hz, 1Φ
G	380~415V, 50Hz, 3Φ

(8) Mode

H	Heat Pump (R410A)
B	Heat Pump (R134a)

















2 Line up

Indoor unit

Model		Capacity (kW)															
		1.5	1.7	2.2	2.8	3.2	3.6	4.5	5.6	6.0	7.1	8.2	9.0	11.2	12.8	14.0	16.0
1Way CST	JSF-0																
	JSF-1																
	JSF-2																
2Way CST																	
4Way CST																	
360 CST																	
Floor Standing Unit																	
4Way CST S (600X600)																	
Duct S (MSP)																	
Slim Duct																	
MSP Duct																	
Home Duct																	
Ceiling																	
Console																	
Boracay																	
Boracay (with EEV)																	
AR5000																	
AR5000 (with EEV)																	

2 Line up

Indoor unit

Model	Capacity (kW)															
	1.5	1.7	2.2	2.8	3.2	3.6	4.5	5.6	6.0	7.1	8.2	9.0	11.2	12.8	14.0	16.0
HSP Duct																
OAP Duct																
Big Duct																
Hydro Unit HE																
Hydro Unit HT																
ERV Plus																

- Make sure to use an indoor unit that is compatible with DVM S.
- If the total capacity of the connected indoor units exceeds the indicated maximum capacity, cooling and heating capacity of the indoor unit may decrease.
- Total capacity of the connected indoor units can be allowed from 50% to 130% of the total outdoor unit capacity.
 $0.5 \times \sum (\text{Outdoor unit capacity}) \leq \text{Total capacity of the connected indoor units} \leq 1.3 \times \sum (\text{Outdoor unit capacity})$

NOTE

- You can connect maximum 64 indoor units to the outdoor unit.
 - Maximum quantity of connectable indoor unit is set to 64 since outdoor unit only support up to 64 communication address. Indoor unit address can be assigned from 0~63. If the indoor unit address was assigned from 64~79, E201 error will occur.
 - Maximum 32 Wall-mount type indoor units with EEV (AM****NQDEH***, AM****NVDKH***) can be connected.

II. Indoor units

1Way Cassette

- 1 *Specifications*
- 2 *Capacity Table*
- 3 *Dimensional Drawing*
- 4 *Electrical Wiring Diagram*
- 5 *Sound Pressure Level*
- 6 *Sound Power Level*
- 7 *Temperature and air flow distribution*

1 Specifications

1Way Cassette

Type			1Way Cassette		1Way Cassette		1Way Cassette		
Model			AM017HN1DEH/EU		AM022FN1DEH/EU		AM022HN1DEH/EU		
Power Supply			Ø, #, V, Hz	1,2,220-240,50		1,2,220-240,50		1,2,220-240,50	
Mode			-	HP/HR		HP/HR		HP/HR	
Performance	Capacity (Nominal)	Cooling	kW	1.70		2.20		2.20	
			Btu/h	5,800		7,500		7,500	
		Heating	kW	1.90		2.50		2.50	
			Btu/h	6,500		8,500		8,500	
Power	Power Input (Nominal)	Cooling	W	24.00		0.40		25.00	
		Heating		24.00		0.40		25.00	
	Current Input (Nominal)	Cooling	A	0.14		0.20		0.15	
		Heating		0.14		0.20		0.15	
Fan	Motor	Type	-	Crossflow Fan		Crossflow Fan		Crossflow Fan	
		Output x n	w	27 x 1		17 x 1		27 x 1	
	Air Flow Rate	H/M/L (UL)	CMM	4.80 / 4.30 / 4.10		6.00 / 5.00 / 4.00		5.10 / 4.60 / 4.30	
			l/s	80.00 / 71.67 / 68.33		100.00 / 83.33 / 66.67		85.00 / 76.67 / 71.67	
	External Pressure	Min/Std/Max	mmAq	-		-		-	
Pa			-		-		-		
Piping Connections	Liquid Pipe	Ø, mm	6.35		6.35		6.35		
		Ø, inch	1/4"		1/4"		1/4"		
	Gas Pipe	Ø, mm	12.70		12.70		12.70		
		Ø, inch	1/2"		1/2"		1/2"		
Drain Pipe	Ø, mm	VP20 (OD 26, ID 20)		VP20 (OD 26, ID 20)		VP20 (OD 26, ID 20)			
Field Wiring	Power Source Wire	mm ²	1.5 - 2.5		1.5 - 2.5		1.5 - 2.5		
	Transmission Cable	mm ²	0.75 - 1.50		0.75 - 1.50		0.75 - 1.50		
Refrigerant	Type	-	R410A		R410A		R410A		
	Control Method	-	EEV(O)		EEV(O)		EEV(O)		
Sound	Pressure	High / Mid / Low	dB(A)	27 / 24 / 21		27 / 25 / 23		27 / 25 / 23	
	Power	Cooling		43		45		46	
Dimension	Net Weight		kg	8.0		10.5		8.0	
	Shipping Weight		kg	10.8		13.0		10.8	
	Net Dimensions (WxHxD)		mm	740 x 135 x 360		970 x 135 x 410		740 x 135 x 360	
	Shipping Dimensions (WxHxD)		mm	895 x 223 x 435		1,164 x 212 x 478		895 x 223 x 435	
Panel Size	Panel model		-	PC1MWSKAN		PC1NUSMAN		PC1MWSKAN	
	Panel Net Weight		kg	2.6		3.1		2.6	
	Shipping Weight		kg	4.2		6.4		4.2	
	Net Dimensions (WxHxD)		mm	900 x 25 x 420		1,198 x 25 x 500		900 x 25 x 420	
	Shipping Dimensions (WxHxD)		mm	958 x 112 x 482		1,262 x 144 x 542		958 x 112 x 482	
Additional Accessories	Drain Pump	Drain Pump	- / Model	-		-		-	
		Max. lifting Height / Displacement	mm/liter/h	-		-		-	
	Air Filter		-	-		-		-	

* Specifications may be subject to change without prior notice for product improvement.

* Mode

- HP : Heat Pump, HR : Heat Recovery

* Nominal cooling capacities are based on;

- Indoor temperature : 27°C DB, 19°C WB

- Outdoor temperature : 35°C DB, 24°C WB, Equivalent refrigerant piping : 7.5m, Level differences : 0m

* Nominal heating capacities are based on;

- Indoor temperature : 20°C DB, 15°C WB

- Outdoor temperature : 7°C DB, 6°C WB, Equivalent refrigerant piping : 7.5m, Level differences : 0m

* Sound pressure was acquired in an anechoic room. Thus actual noise level may be different depending on the installation conditions.

* These products contain R410A which is fluorinated greenhouse gas.

* Heat Exchanger type : Fin & Tube (Fin : Al, Tube : Cu)

1 Specifications

1Way Cassette

Type			1Way Cassette		1Way Cassette	
Model			AM028FN1DEH/EU		AM036FN1DEH/EU	
Power Supply			Ø, #, V, Hz	1,2,220-240,50	1,2,220-240,50	
Mode			-	HP/HR	HP/HR	
Performance	Capacity (Nominal)	Cooling	kW	2.80	3.60	
			Btu/h	9,600	12,300	
		Heating	kW	3.20	4.00	
			Btu/h	10,900	13,600	
Power	Power Input (Nominal)	Cooling	W	45.00	50.00	
		Heating	W	45.00	50.00	
	Current Input (Nominal)	Cooling	A	0.23	0.25	
		Heating	A	0.23	0.25	
Fan	Motor	Type	-	Crossflow Fan	Crossflow Fan	
		Output x n	w	17 x 1	17 x 1	
	Air Flow Rate	H/M/L (UL)	CMM	7.00 / 6.00 / 5.00	8.00 / 7.00 / 6.00	
			l/s	116.67 / 100.00 / 83.33	133.33 / 116.67 / 100.00	
	External Pressure	Min/Std/Max	mmAq	-	-	
			Pa	-	-	
Piping Connections	Liquid Pipe	Ø, mm	6.35	6.35		
		Ø, inch	1/4"	1/4"		
	Gas Pipe	Ø, mm	12.70	12.70		
		Ø, inch	1/2"	1/2"		
	Drain Pipe	Ø, mm	VP20 (OD 26, ID 20)	VP20 (OD 26, ID 20)		
Field Wiring	Power Source Wire	mm ²	1.5 - 2.5	1.5 - 2.5		
	Transmission Cable	mm ²	0.75 - 1.50	0.75 - 1.50		
Refrigerant	Type	-	R410A	R410A		
	Control Method	-	EEV(O)	EEV(O)		
Sound	Pressure	High / Mid / Low	dB(A)	29 / 27 / 24	35 / 31 / 27	
	Power	Cooling		48	52	
Dimension	Net Weight		kg	10.5	10.5	
	Shipping Weight		kg	13.0	13.0	
	Net Dimensions (WxHxD)		mm	970 x 135 x 410	970 x 135 x 410	
	Shipping Dimensions (WxHxD)		mm	1,164 x 212 x 478	1,164 x 212 x 478	
Panel Size	Panel model		-	PC1NUSMAN	PC1NUSMAN	
	Panel Net Weight		kg	3.1	3.1	
	Shipping Weight		kg	6.4	6.4	
	Net Dimensions (WxHxD)		mm	1,198 x 25 x 500	1,198 x 25 x 500	
	Shipping Dimensions (WxHxD)		mm	1,262 x 144 x 542	1,262 x 144 x 542	
Additional Accessories	Drain Pump	Drain Pump	- / Model	-	-	
		Max. lifting Height / Displacement	mm/liter/h	-	-	
	Air Filter		-	-	-	

* Specifications may be subject to change without prior notice for product improvement.

* Mode

- HP : Heat Pump, HR : Heat Recovery

* Nominal cooling capacities are based on;

- Indoor temperature : 27°C DB, 19°C WB

- Outdoor temperature : 35°C DB, 24°C WB, Equivalent refrigerant piping : 7.5m, Level differences : 0m

* Nominal heating capacities are based on;

- Indoor temperature : 20°C DB, 15°C WB

- Outdoor temperature : 7°C DB, 6°C WB, Equivalent refrigerant piping : 7.5m, Level differences : 0m

* Sound pressure was acquired in an anechoic room. Thus actual noise level may be different depending on the installation conditions.

* These products contain R410A which is fluorinated greenhouse gas.

* Heat Exchanger type : Fin & Tube (Fin : Al, Tube : Cu)

1 Specifications

1Way Cassette

Type			1Way Cassette		1Way Cassette	
Model			AM056JN1DEH/EU		AM071JN1DEH/EU	
Power Supply			Ø, #, V, Hz	1,2,220-240,50		1,2,220-240,50
Mode			-	HP/HR		HP/HR
Performance	Capacity (Nominal)	Cooling	kW	5.60	7.10	
			Btu/h	19,100	24,200	
		Heating	kW	6.30	8.00	
			Btu/h	21,500	27,300	
Power	Power Input (Nominal)	Cooling	W	55.00	80.00	
		Heating		55.00	80.00	
	Current Input (Nominal)	Cooling	A	0.28	0.40	
		Heating		0.28	0.40	
Fan	Motor	Type	-	Crossflow Fan		Crossflow Fan
		Output x n	w	54 x 1		54 x 1
	Air Flow Rate	H/M/L (UL)	CMM	16.00 / 14.00 / 12.50		17.00 / 15.50 / 14.00
			l/s	266.67 / 233.33 / 208.33		283.33 / 258.33 / 233.33
	External Pressure	Min/Std/Max	mmAq	-		-
Pa			-		-	
Piping Connections	Liquid Pipe	Ø, mm	6.35	9.52		
		Ø, inch	1/4"	3/8"		
	Gas Pipe	Ø, mm	12.70	15.88		
		Ø, inch	1/2"	5/8"		
	Drain Pipe	Ø, mm	VP20 (OD 25, ID 20)		VP20 (OD 25, ID 20)	
Field Wiring	Power Source Wire	mm ²	1.5 - 2.5		1.5 - 2.5	
	Transmission Cable	mm ²	0.75 - 1.50		0.75 - 1.50	
Refrigerant	Type	-	R410A		R410A	
	Control Method	-	EEV INCLUDED		EEV INCLUDED	
Sound	Pressure	High / Mid / Low	dB(A)	36.0 / 33.0 / 31.0		39.0 / 37.0 / 34.0
	Power	Cooling		58.0		60.0
Dimension	Net Weight		kg	14.50		14.50
	Shipping Weight		kg	18.50		18.50
	Net Dimensions (WxHxD)		mm	1,200 x 138 x 450		1,200 x 138 x 450
	Shipping Dimensions (WxHxD)		mm	1,435 x 224 x 525		1,435 x 224 x 525
Panel Size	Panel model		-	PC1BWSMAN		PC1BWSMAN
	Panel Net Weight		kg	6.30		6.30
	Shipping Weight		kg	8.30		8.30
	Net Dimensions (WxHxD)		mm	1,410 x 23 x 500		1,410 x 23 x 500
	Shipping Dimensions (WxHxD)		mm	1,474 x 122 x 566		1,474 x 122 x 566
Additional Accessories	Drain Pump	Drain Pump	- / Model	-		-
		Max. lifting Height / Displacement	mm/liter/h	-		-
	Air Filter		-	-		-

* Specifications may be subject to change without prior notice for product improvement.

* Mode

- HP : Heat Pump, HR : Heat Recovery

* Nominal cooling capacities are based on;

- Indoor temperature : 27°C DB, 19°C WB

- Outdoor temperature : 35°C DB, 24°C WB, Equivalent refrigerant piping : 7.5m, Level differences : 0m

* Nominal heating capacities are based on;

- Indoor temperature : 20°C DB, 15°C WB

- Outdoor temperature : 7°C DB, 6°C WB, Equivalent refrigerant piping : 7.5m, Level differences : 0m

* Sound pressure was acquired in an anechoic room. Thus actual noise level may be different depending on the installation conditions.

* These products contain R410A which is fluorinated greenhouse gas.

* Heat Exchanger type : Fin & Tube (Fin : Al, Tube : Cu)

2 Capacity table

1Way Cassette

Cooling

TC : Total Capacity, SHC : Sensible Heat Capacity

Capacity Index	Outdoor Air Temp. (°C, DB)	Indoor temperature													
		20(°C, DB)		23(°C, DB)		26(°C, DB)		27(°C, DB)		28(°C, DB)		30(°C, DB)		32(°C, DB)	
		14(°C, WB)		16(°C, WB)		18(°C, WB)		19(°C, WB)		20(°C, WB)		22(°C, WB)		24(°C, WB)	
		TC	SHC	TC	SHC	TC	SHC	TC	SHC	TC	SHC	TC	SHC	TC	SHC
017	10	1.2	1.0	1.4	1.1	1.6	1.2	1.7	1.2	1.8	1.2	1.9	1.2	2.0	1.1
	12	1.2	1.0	1.4	1.1	1.6	1.2	1.7	1.2	1.8	1.2	1.9	1.2	2.0	1.1
	14	1.2	1.0	1.4	1.1	1.6	1.2	1.7	1.2	1.8	1.2	1.9	1.2	2.0	1.1
	16	1.2	1.0	1.4	1.1	1.6	1.2	1.7	1.2	1.8	1.2	1.9	1.2	2.0	1.1
	18	1.2	1.0	1.4	1.1	1.6	1.2	1.7	1.2	1.8	1.2	1.9	1.2	2.0	1.1
	20	1.2	1.0	1.4	1.1	1.6	1.2	1.7	1.2	1.8	1.2	1.9	1.2	2.0	1.1
	21	1.2	1.0	1.4	1.1	1.6	1.2	1.7	1.2	1.8	1.2	1.9	1.2	2.0	1.1
	23	1.2	1.0	1.4	1.1	1.6	1.2	1.7	1.2	1.8	1.2	1.9	1.2	2.0	1.1
	25	1.2	1.0	1.4	1.1	1.6	1.2	1.7	1.2	1.8	1.2	1.9	1.2	2.0	1.1
	27	1.2	1.0	1.4	1.1	1.6	1.2	1.7	1.2	1.8	1.2	1.9	1.2	2.0	1.1
	29	1.2	1.0	1.4	1.1	1.6	1.2	1.7	1.2	1.8	1.2	1.9	1.2	2.0	1.1
	31	1.2	1.0	1.4	1.1	1.6	1.2	1.7	1.2	1.8	1.2	1.9	1.2	2.0	1.1
	33	1.2	1.0	1.4	1.1	1.6	1.2	1.7	1.2	1.8	1.2	1.9	1.2	2.0	1.1
	35	1.2	1.0	1.4	1.1	1.6	1.2	1.7	1.2	1.8	1.2	1.9	1.2	2.0	1.1
	37	1.2	1.0	1.4	1.1	1.6	1.2	1.7	1.2	1.8	1.2	1.9	1.2	2.0	1.1
	39	1.2	1.0	1.4	1.1	1.6	1.2	1.7	1.2	1.8	1.2	1.9	1.2	2.0	1.1
42	1.2	1.0	1.4	1.1	1.6	1.2	1.7	1.2	1.8	1.2	1.9	1.2	1.9	1.1	
44	1.2	1.0	1.4	1.1	1.5	1.2	1.6	1.1	1.7	1.2	1.8	1.1	1.9	1.0	
46	1.2	1.0	1.4	1.1	1.5	1.1	1.6	1.1	1.7	1.1	1.7	1.1	1.8	1.0	
48	1.2	1.0	1.4	1.1	1.5	1.1	1.5	1.1	1.6	1.1	1.7	1.1	1.8	1.0	
022	10	1.5	1.3	1.8	1.4	2.1	1.5	2.2	1.5	2.3	1.5	2.5	1.6	2.6	1.4
	12	1.5	1.3	1.8	1.4	2.1	1.5	2.2	1.5	2.3	1.5	2.5	1.6	2.6	1.4
	14	1.5	1.3	1.8	1.4	2.1	1.5	2.2	1.5	2.3	1.5	2.5	1.6	2.6	1.4
	16	1.5	1.3	1.8	1.4	2.1	1.5	2.2	1.5	2.3	1.5	2.4	1.5	2.6	1.4
	18	1.5	1.3	1.8	1.4	2.1	1.5	2.2	1.5	2.3	1.5	2.4	1.5	2.6	1.4
	20	1.5	1.3	1.8	1.4	2.1	1.5	2.2	1.5	2.3	1.5	2.4	1.5	2.6	1.4
	21	1.5	1.3	1.8	1.4	2.1	1.5	2.2	1.5	2.3	1.5	2.4	1.5	2.6	1.4
	23	1.5	1.3	1.8	1.4	2.1	1.5	2.2	1.5	2.3	1.5	2.4	1.5	2.6	1.4
	25	1.5	1.3	1.8	1.4	2.1	1.5	2.2	1.5	2.3	1.5	2.4	1.5	2.6	1.4
	27	1.5	1.3	1.8	1.4	2.1	1.5	2.2	1.5	2.3	1.5	2.4	1.5	2.6	1.4
	29	1.5	1.3	1.8	1.4	2.1	1.5	2.2	1.5	2.3	1.5	2.4	1.5	2.6	1.4
	31	1.5	1.3	1.8	1.4	2.1	1.5	2.2	1.5	2.3	1.5	2.4	1.5	2.6	1.4
	33	1.5	1.3	1.8	1.4	2.1	1.5	2.2	1.5	2.3	1.5	2.4	1.5	2.6	1.4
	35	1.5	1.3	1.8	1.4	2.1	1.5	2.2	1.5	2.3	1.5	2.4	1.5	2.6	1.4
	37	1.5	1.3	1.8	1.4	2.1	1.5	2.2	1.5	2.3	1.5	2.4	1.5	2.6	1.4
	39	1.5	1.3	1.8	1.4	2.1	1.5	2.2	1.5	2.3	1.5	2.4	1.5	2.5	1.3
42	1.5	1.3	1.8	1.4	2.1	1.5	2.2	1.5	2.3	1.5	2.4	1.5	2.4	1.3	
44	1.5	1.3	1.8	1.4	2.0	1.4	2.1	1.4	2.2	1.4	2.3	1.4	2.4	1.2	
46	1.5	1.3	1.8	1.4	2.0	1.4	2.0	1.4	2.1	1.4	2.2	1.4	2.3	1.2	
48	1.5	1.3	1.8	1.4	2.0	1.4	2.0	1.3	2.1	1.4	2.1	1.3	2.2	1.1	
028	10	1.9	1.6	2.3	1.8	2.6	1.9	2.8	1.9	2.9	1.9	3.1	1.9	3.4	1.9
	12	1.9	1.6	2.3	1.8	2.6	1.9	2.8	1.9	2.9	1.9	3.1	1.9	3.3	1.8
	14	1.9	1.6	2.3	1.8	2.6	1.9	2.8	1.9	2.9	1.9	3.1	1.9	3.3	1.8
	16	1.9	1.6	2.3	1.8	2.6	1.9	2.8	1.9	2.9	1.9	3.1	1.9	3.3	1.8
	18	1.9	1.6	2.3	1.8	2.6	1.9	2.8	1.9	2.9	1.9	3.1	1.9	3.3	1.8
	20	1.9	1.6	2.3	1.8	2.6	1.9	2.8	1.9	2.9	1.9	3.1	1.9	3.3	1.8
	21	1.9	1.6	2.3	1.8	2.6	1.9	2.8	1.9	2.9	1.9	3.1	1.9	3.3	1.8
	23	1.9	1.6	2.3	1.8	2.6	1.9	2.8	1.9	2.9	1.9	3.1	1.9	3.3	1.8
	25	1.9	1.6	2.3	1.8	2.6	1.9	2.8	1.9	2.9	1.9	3.1	1.9	3.3	1.8
	27	1.9	1.6	2.3	1.8	2.6	1.9	2.8	1.9	2.9	1.9	3.1	1.9	3.3	1.8
	29	1.9	1.6	2.3	1.8	2.6	1.9	2.8	1.9	2.9	1.9	3.1	1.9	3.3	1.8
	31	1.9	1.6	2.3	1.8	2.6	1.9	2.8	1.9	2.9	1.9	3.1	1.9	3.3	1.8
	33	1.9	1.6	2.3	1.8	2.6	1.9	2.8	1.9	2.9	1.9	3.1	1.9	3.3	1.8
	35	1.9	1.6	2.3	1.8	2.6	1.9	2.8	1.9	2.9	1.9	3.1	1.9	3.3	1.8
	37	1.9	1.6	2.3	1.8	2.6	1.9	2.8	1.9	2.9	1.9	3.1	1.9	3.3	1.8
	39	1.9	1.6	2.3	1.8	2.6	1.9	2.8	1.9	2.9	1.9	3.0	1.8	3.2	1.7
42	1.9	1.6	2.3	1.8	2.6	1.9	2.8	1.9	2.9	1.9	2.9	1.8	3.1	1.7	
44	1.9	1.6	2.3	1.8	2.5	1.8	2.7	1.8	2.8	1.8	2.8	1.7	3.0	1.6	
46	1.9	1.6	2.3	1.8	2.5	1.8	2.6	1.8	2.7	1.8	2.7	1.6	2.9	1.6	
48	1.9	1.6	2.2	1.8	2.4	1.8	2.5	1.7	2.6	1.7	2.7	1.6	2.8	1.5	

2 Capacity table

1Way Cassette

Cooling

TC : Total Capacity, SHC : Sensible Heat Capacity

Capacity Index	Outdoor Air Temp. (°C, DB)	Indoor temperature													
		20(°C, DB)		23(°C, DB)		26(°C, DB)		27(°C, DB)		28(°C, DB)		30(°C, DB)		32(°C, DB)	
		14(°C, WB)		16(°C, WB)		18(°C, WB)		19(°C, WB)		20(°C, WB)		22(°C, WB)		24(°C, WB)	
	TC	SHC	TC	SHC	TC	SHC	TC	SHC	TC	SHC	TC	SHC	TC	SHC	
036	10	2.5	2.2	2.9	2.4	3.4	2.4	3.6	2.6	3.7	2.6	4.0	2.6	4.3	2.5
	12	2.5	2.2	2.9	2.4	3.4	2.4	3.6	2.6	3.7	2.6	4.0	2.6	4.3	2.5
	14	2.5	2.2	2.9	2.4	3.4	2.4	3.6	2.6	3.7	2.6	4.0	2.6	4.3	2.5
	16	2.5	2.2	2.9	2.4	3.4	2.4	3.6	2.6	3.7	2.6	4.0	2.6	4.3	2.5
	18	2.5	2.2	2.9	2.4	3.4	2.4	3.6	2.6	3.7	2.6	4.0	2.6	4.3	2.5
	20	2.5	2.2	2.9	2.4	3.4	2.4	3.6	2.6	3.7	2.6	4.0	2.6	4.2	2.4
	21	2.5	2.2	2.9	2.4	3.4	2.4	3.6	2.6	3.7	2.6	4.0	2.6	4.2	2.4
	23	2.5	2.2	2.9	2.4	3.4	2.4	3.6	2.6	3.7	2.6	4.0	2.6	4.2	2.4
	25	2.5	2.2	2.9	2.4	3.4	2.4	3.6	2.6	3.7	2.6	4.0	2.6	4.2	2.4
	27	2.5	2.2	2.9	2.4	3.4	2.4	3.6	2.6	3.7	2.6	4.0	2.6	4.2	2.4
	29	2.5	2.2	2.9	2.4	3.4	2.4	3.6	2.6	3.7	2.6	4.0	2.6	4.2	2.4
	31	2.5	2.2	2.9	2.4	3.4	2.4	3.6	2.6	3.7	2.6	4.0	2.6	4.2	2.4
	33	2.5	2.2	2.9	2.4	3.4	2.4	3.6	2.6	3.7	2.6	4.0	2.6	4.2	2.4
	35	2.5	2.2	2.9	2.4	3.4	2.4	3.6	2.6	3.7	2.6	4.0	2.6	4.2	2.4
	37	2.5	2.2	2.9	2.4	3.4	2.4	3.6	2.6	3.7	2.6	3.9	2.5	4.2	2.4
	39	2.5	2.2	2.9	2.4	3.4	2.4	3.6	2.6	3.7	2.6	3.9	2.5	4.1	2.3
42	2.5	2.2	2.9	2.4	3.4	2.4	3.6	2.6	3.7	2.6	3.8	2.5	4.0	2.2	
44	2.5	2.2	2.9	2.4	3.3	2.3	3.4	2.5	3.6	2.5	3.7	2.4	3.9	2.2	
46	2.5	2.2	2.9	2.4	3.2	2.3	3.3	2.4	3.4	2.4	3.6	2.3	3.8	2.1	
48	2.5	2.2	2.8	2.3	3.2	2.2	3.2	2.3	3.4	2.4	3.5	2.2	3.6	2.0	
056	10	3.9	3.2	4.6	3.5	5.3	3.9	5.6	3.9	5.8	3.9	6.3	3.9	6.7	3.7
	12	3.9	3.2	4.6	3.5	5.3	3.9	5.6	3.9	5.8	3.9	6.3	3.9	6.7	3.7
	14	3.9	3.2	4.6	3.5	5.3	3.9	5.6	3.9	5.8	3.9	6.2	3.8	6.7	3.7
	16	3.9	3.2	4.6	3.5	5.3	3.9	5.6	3.9	5.8	3.9	6.2	3.8	6.6	3.6
	18	3.9	3.2	4.6	3.5	5.3	3.9	5.6	3.9	5.8	3.9	6.2	3.8	6.6	3.6
	20	3.9	3.2	4.6	3.5	5.3	3.9	5.6	3.9	5.8	3.9	6.2	3.8	6.6	3.6
	21	3.9	3.2	4.6	3.5	5.3	3.9	5.6	3.9	5.8	3.9	6.2	3.8	6.6	3.6
	23	3.9	3.2	4.6	3.5	5.3	3.9	5.6	3.9	5.8	3.9	6.2	3.8	6.6	3.6
	25	3.9	3.2	4.6	3.5	5.3	3.9	5.6	3.9	5.8	3.9	6.2	3.8	6.6	3.6
	27	3.9	3.2	4.6	3.5	5.3	3.9	5.6	3.9	5.8	3.9	6.2	3.8	6.6	3.6
	29	3.9	3.2	4.6	3.5	5.3	3.9	5.6	3.9	5.8	3.9	6.2	3.8	6.6	3.6
	31	3.9	3.2	4.6	3.5	5.3	3.9	5.6	3.9	5.8	3.9	6.2	3.8	6.6	3.6
	33	3.9	3.2	4.6	3.5	5.3	3.9	5.6	3.9	5.8	3.9	6.2	3.8	6.6	3.6
	35	3.9	3.2	4.6	3.5	5.3	3.9	5.6	3.9	5.8	3.9	6.2	3.8	6.6	3.6
	37	3.9	3.2	4.6	3.5	5.3	3.9	5.6	3.9	5.8	3.9	6.2	3.8	6.6	3.5
	39	3.9	3.2	4.6	3.5	5.3	3.9	5.6	3.9	5.8	3.9	6.2	3.8	6.6	3.4
42	3.9	3.2	4.6	3.5	5.3	3.9	5.5	3.8	5.7	3.9	6.1	3.7	6.4	3.3	
44	3.9	3.2	4.6	3.5	5.1	3.8	5.3	3.7	5.6	3.7	5.9	3.6	6.2	3.2	
46	3.9	3.2	4.6	3.5	5.0	3.7	5.2	3.6	5.4	3.6	5.7	3.5	6.0	3.1	
48	3.9	3.2	4.5	3.4	5.0	3.6	5.0	3.5	5.3	3.6	5.5	3.4	5.8	3.0	
071	10	4.9	4.0	5.8	4.5	6.7	4.8	7.1	5.0	7.4	5.0	8.0	5.1	8.5	4.8
	12	4.9	4.0	5.8	4.5	6.7	4.8	7.1	5.0	7.4	5.0	7.9	5.0	8.5	4.8
	14	4.9	4.0	5.8	4.5	6.7	4.8	7.1	5.0	7.4	5.0	7.9	5.0	8.5	4.8
	16	4.9	4.0	5.8	4.5	6.7	4.8	7.1	5.0	7.4	5.0	7.9	5.0	8.4	4.8
	18	4.9	4.0	5.8	4.5	6.7	4.8	7.1	5.0	7.4	5.0	7.9	5.0	8.4	4.8
	20	4.9	4.0	5.8	4.5	6.7	4.8	7.1	5.0	7.4	5.0	7.9	5.0	8.4	4.8
	21	4.9	4.0	5.8	4.5	6.7	4.8	7.1	5.0	7.4	5.0	7.9	5.0	8.4	4.8
	23	4.9	4.0	5.8	4.5	6.7	4.8	7.1	5.0	7.4	5.0	7.9	5.0	8.4	4.8
	25	4.9	4.0	5.8	4.5	6.7	4.8	7.1	5.0	7.4	5.0	7.9	5.0	8.4	4.8
	27	4.9	4.0	5.8	4.5	6.7	4.8	7.1	5.0	7.4	5.0	7.9	5.0	8.4	4.8
	29	4.9	4.0	5.8	4.5	6.7	4.8	7.1	5.0	7.4	5.0	7.9	5.0	8.4	4.8
	31	4.9	4.0	5.8	4.5	6.7	4.8	7.1	5.0	7.4	5.0	7.9	5.0	8.4	4.8
	33	4.9	4.0	5.8	4.5	6.7	4.8	7.1	5.0	7.4	5.0	7.9	5.0	8.4	4.8
	35	4.9	4.0	5.8	4.5	6.7	4.8	7.1	5.0	7.4	5.0	7.9	5.0	8.4	4.8
	37	4.9	4.0	5.8	4.5	6.7	4.8	7.1	5.0	7.3	4.9	7.8	4.9	8.2	4.7
	39	4.9	4.0	5.8	4.5	6.7	4.8	7.1	5.0	7.3	4.9	7.7	4.8	8.1	4.6
42	4.9	4.0	5.8	4.5	6.7	4.8	7.0	4.9	7.2	4.8	7.6	4.7	7.9	4.5	
44	4.9	4.0	5.8	4.5	6.5	4.6	6.8	4.8	7.0	4.7	7.3	4.5	7.6	4.3	
46	4.9	4.0	5.7	4.5	6.4	4.6	6.6	4.6	6.8	4.6	7.0	4.4	7.4	4.2	
48	4.8	3.9	5.7	4.4	6.3	4.5	6.4	4.5	6.7	4.5	6.8	4.3	7.2	4.1	

2 Capacity table

1Way Cassette

Heating

TC : Total Capacity

Capacity Index	Outdoor Air Temp. (°C)		Indoor temperature (°C,DB)				
			16(°C,DB)	18(°C,DB)	20(°C,DB)	22(°C,DB)	24(°C,DB)
	DB	WB	TC kW	TC kW	TC kW	TC kW	TC kW
017	-19.8	-20.0	1.1	1.1	1.1	1.1	1.1
	-18.8	-19.0	1.1	1.1	1.1	1.1	1.1
	-16.7	-17.0	1.2	1.2	1.2	1.2	1.2
	-14.7	-15.0	1.3	1.2	1.2	1.2	1.2
	-12.6	-13.0	1.4	1.4	1.4	1.4	1.3
	-10.5	-11.0	1.5	1.5	1.4	1.4	1.4
	-9.5	-10.0	1.5	1.5	1.5	1.4	1.4
	-8.5	-9.1	1.6	1.6	1.6	1.5	1.5
	-7.0	-7.6	1.7	1.7	1.7	1.5	1.5
	-5.0	-5.6	1.8	1.7	1.7	1.7	1.7
	-3.0	-3.7	1.9	1.9	1.8	1.7	1.7
	0.0	-0.7	2.0	1.9	1.9	1.7	1.7
	3.0	2.2	2.1	2.0	1.9	1.7	1.7
	5.0	4.1	2.1	2.1	1.9	1.7	1.7
	7.0	6.0	2.1	2.1	1.9	1.7	1.7
9.0	7.9	2.3	2.1	1.9	1.7	1.7	
022	-19.8	-20.0	1.5	1.5	1.5	1.5	1.5
	-18.8	-19.0	1.5	1.5	1.5	1.5	1.5
	-16.7	-17.0	1.6	1.6	1.6	1.6	1.6
	-14.7	-15.0	1.7	1.6	1.6	1.6	1.6
	-12.6	-13.0	1.8	1.8	1.8	1.8	1.7
	-10.5	-11.0	2.0	2.0	1.9	1.9	1.9
	-9.5	-10.0	2.1	2.0	2.0	1.9	1.9
	-8.5	-9.1	2.2	2.1	2.1	2.0	2.0
	-7.0	-7.6	2.3	2.2	2.2	2.0	2.0
	-5.0	-5.6	2.4	2.3	2.3	2.2	2.2
	-3.0	-3.7	2.5	2.5	2.4	2.3	2.2
	0.0	-0.7	2.6	2.5	2.5	2.3	2.2
	3.0	2.2	2.7	2.6	2.5	2.3	2.2
	5.0	4.1	2.8	2.7	2.5	2.3	2.2
	7.0	6.0	2.8	2.7	2.5	2.3	2.2
9.0	7.9	3.0	2.7	2.5	2.3	2.2	
028	-19.8	-20.0	1.9	1.9	1.9	1.9	1.9
	-18.8	-19.0	1.9	1.9	1.9	1.9	1.9
	-16.7	-17.0	2.0	2.0	2.0	2.0	1.9
	-14.7	-15.0	2.1	2.1	2.0	2.0	1.9
	-12.6	-13.0	2.2	2.2	2.2	2.1	2.1
	-10.5	-11.0	2.3	2.3	2.3	2.3	2.2
	-9.5	-10.0	2.3	2.3	2.3	2.3	2.2
	-8.5	-9.1	2.4	2.4	2.4	2.4	2.3
	-7.0	-7.6	2.5	2.4	2.4	2.4	2.3
	-5.0	-5.6	2.6	2.6	2.5	2.5	2.4
	-3.0	-3.7	2.8	2.7	2.7	2.6	2.5
	0.0	-0.7	2.9	2.8	2.8	2.7	2.6
	3.0	2.2	3.0	3.0	2.9	2.8	2.7
	5.0	4.1	3.2	3.1	3.1	2.9	2.7
	7.0	6.0	3.3	3.2	3.2	3.0	2.7
9.0	7.9	3.4	3.3	3.2	3.0	2.7	
11.0	9.8	3.5	3.3	3.2	3.0	2.7	
13.0	11.8	3.6	3.4	3.2	3.0	2.7	
15.0	13.7	3.7	3.4	3.2	3.0	2.7	

2 Capacity table

1Way Cassette

Heating

TC : Total Capacity

Capacity Index	Outdoor Air Temp. (°C)		Indoor temperature (°C,DB)				
			16(°C,DB)	18(°C,DB)	20(°C,DB)	22(°C,DB)	24(°C,DB)
	DB	WB	TC kW	TC kW	TC kW	TC kW	TC kW
036	-19.8	-20.0	2.4	2.4	2.3	2.3	2.3
	-18.8	-19.0	2.5	2.4	2.3	2.3	2.3
	-16.7	-17.0	2.6	2.5	2.4	2.4	2.3
	-14.7	-15.0	2.7	2.6	2.5	2.5	2.4
	-12.6	-13.0	2.8	2.7	2.7	2.6	2.6
	-10.5	-11.0	2.9	2.9	2.9	2.8	2.8
	-9.5	-10.0	2.9	2.9	2.9	2.8	2.8
	-8.5	-9.1	3.0	3.0	3.0	2.9	2.9
	-7.0	-7.6	3.1	3.1	3.0	3.0	2.9
	-5.0	-5.6	3.3	3.2	3.2	3.1	3.0
	-3.0	-3.7	3.4	3.4	3.3	3.2	3.1
	0.0	-0.7	3.6	3.6	3.5	3.4	3.2
	3.0	2.2	3.8	3.7	3.7	3.5	3.4
	5.0	4.1	3.9	3.9	3.8	3.6	3.4
	7.0	6.0	4.1	4.1	4.0	3.7	3.4
9.0	7.9	4.2	4.1	4.0	3.7	3.4	
11.0	9.8	4.4	4.2	4.0	3.7	3.4	
13.0	11.8	4.5	4.2	4.0	3.7	3.4	
15.0	13.7	4.6	4.3	4.0	3.7	3.4	
056	-19.8	-20.0	3.9	3.8	3.8	3.7	3.7
	-18.8	-19.0	3.9	3.9	3.8	3.7	3.7
	-16.7	-17.0	4.0	4.0	3.9	3.8	3.8
	-14.7	-15.0	4.2	4.1	4.0	3.9	3.8
	-12.6	-13.0	4.4	4.3	4.2	4.1	4.0
	-10.5	-11.0	4.6	4.5	4.4	4.4	4.3
	-9.5	-10.0	4.7	4.6	4.6	4.5	4.4
	-8.5	-9.1	4.8	4.7	4.7	4.6	4.5
	-7.0	-7.6	4.9	4.8	4.8	4.7	4.5
	-5.0	-5.6	5.2	5.1	5.0	4.9	4.7
	-3.0	-3.7	5.4	5.3	5.3	5.1	4.9
	0.0	-0.7	5.7	5.6	5.5	5.3	5.0
	3.0	2.2	5.9	5.9	5.8	5.6	5.3
	5.0	4.1	6.2	6.1	6.0	5.7	5.3
	7.0	6.0	6.5	6.4	6.3	5.8	5.3
9.0	7.9	6.7	6.5	6.3	5.8	5.3	
11.0	9.8	6.9	6.6	6.3	5.8	5.3	
13.0	11.8	7.1	6.7	6.3	5.8	5.3	
15.0	13.7	7.3	6.8	6.3	5.8	5.3	
071	-19.8	-20.0	4.9	4.9	4.8	4.7	4.7
	-18.8	-19.0	5.0	4.9	4.8	4.7	4.7
	-16.7	-17.0	5.1	5.0	4.9	4.8	4.8
	-14.7	-15.0	5.3	5.2	5.1	4.9	4.8
	-12.6	-13.0	5.5	5.4	5.3	5.2	5.1
	-10.5	-11.0	5.8	5.7	5.6	5.5	5.5
	-9.5	-10.0	6.0	5.9	5.8	5.7	5.6
	-8.5	-9.1	6.1	6.0	5.9	5.8	5.7
	-7.0	-7.6	6.2	6.1	6.0	5.9	5.8
	-5.0	-5.6	6.5	6.5	6.4	6.2	6.0
	-3.0	-3.7	6.9	6.8	6.7	6.4	6.2
	0.0	-0.7	7.2	7.1	7.0	6.7	6.4
	3.0	2.2	7.6	7.5	7.3	7.1	6.8
	5.0	4.1	7.9	7.8	7.7	7.2	6.8
	7.0	6.0	8.2	8.1	8.0	7.4	6.8
9.0	7.9	8.5	8.2	8.0	7.4	6.8	
11.0	9.8	8.7	8.4	8.0	7.4	6.8	
13.0	11.8	9.0	8.5	8.0	7.4	6.8	
15.0	13.7	9.2	8.6	8.0	7.4	6.8	

3 Dimensional drawing

1Way Cassette

AM017HN1DEH/EU, AM022HN1DEH/EU

Units : mm / inches

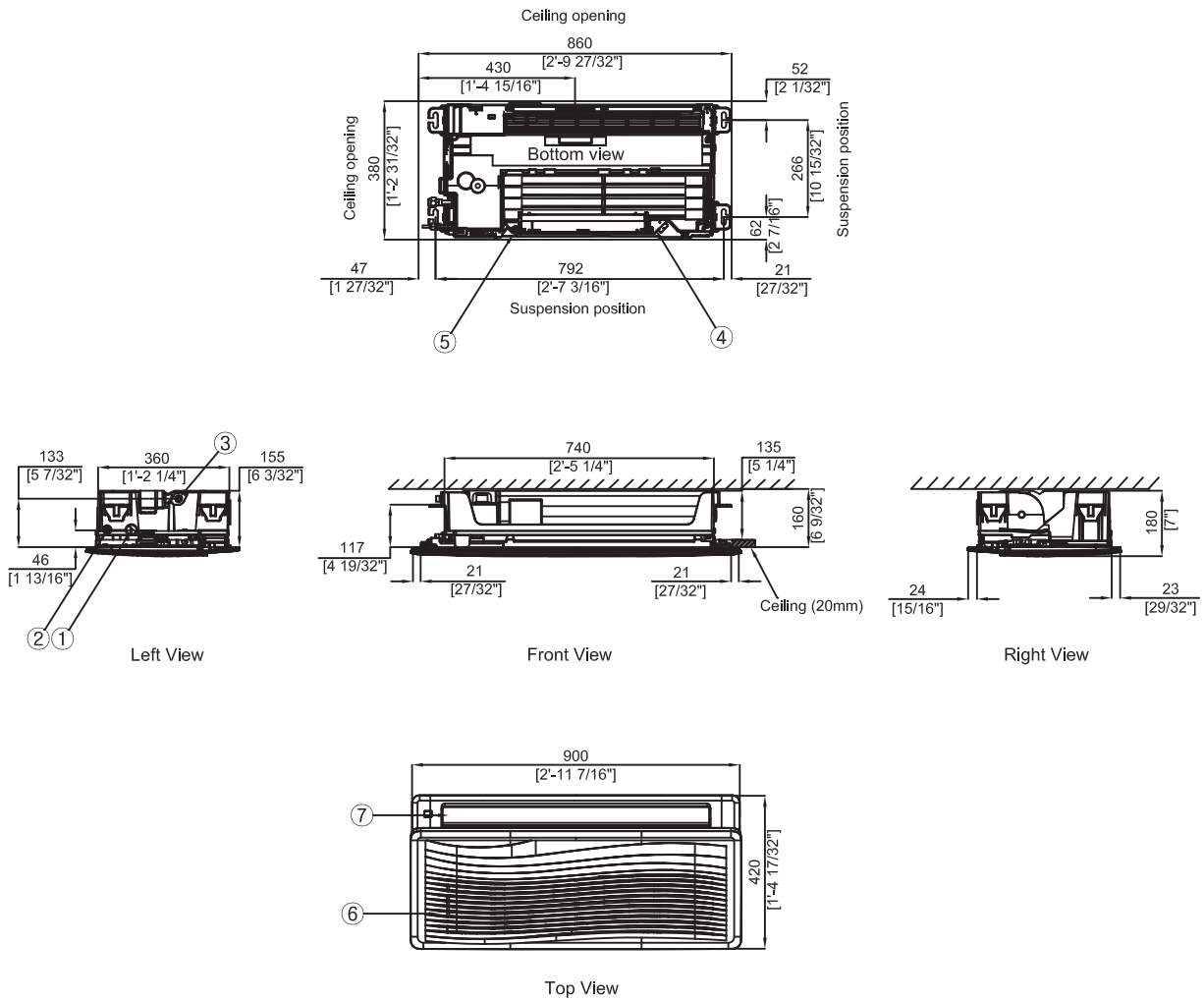

Table of descriptions

1	Refrigerant gas pipe	7	Air outlet louver
2	Refrigerant liquid pipe	8	
3	Drain pipe	9	
4	Power supply wiring conduit	10	
5	Communication wiring conduit	11	
6	Air inlet grille	12	

3 Dimensional drawing

1Way Cassette

AM022FN1DEH/EU, AM028FN1DEH/EU, AM036FN1DEH/EU

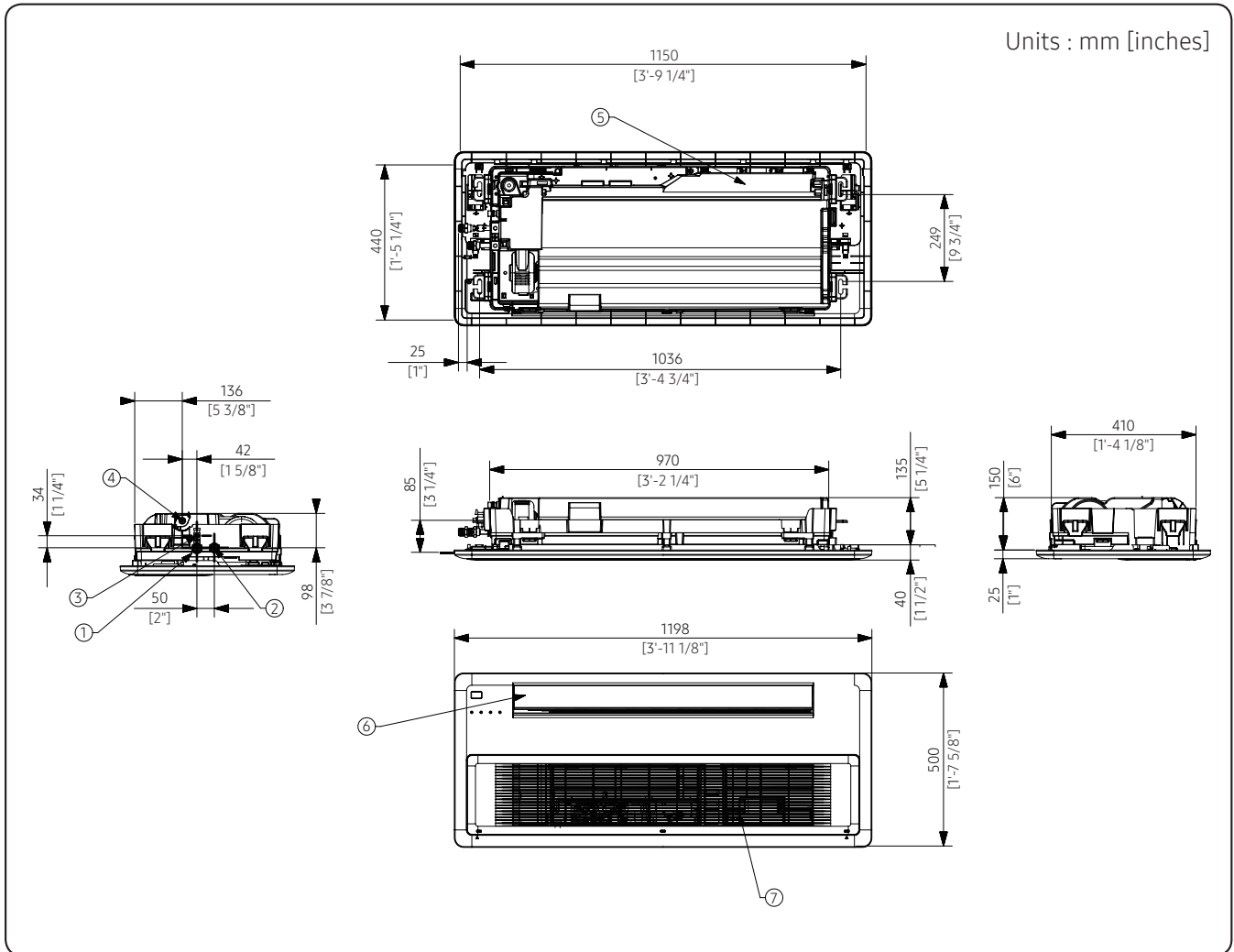

No	Name	Description
1	Water pipe connection out	PF Male 3/4" (20A)
2	Water pipe connection in	PF Male 3/4" (20A)
3	Air vent valve	-
4	Drain hose	VP20 (OD26, ID20)
5	Power supply & Communication wiring conduit	-
6	Air discharge part	-
7	Air suction part	-

3 Dimensional drawing

1Way Cassette

AM056JN1DEH/EU, AM071JN1DEH/EU

Units : mm / inches

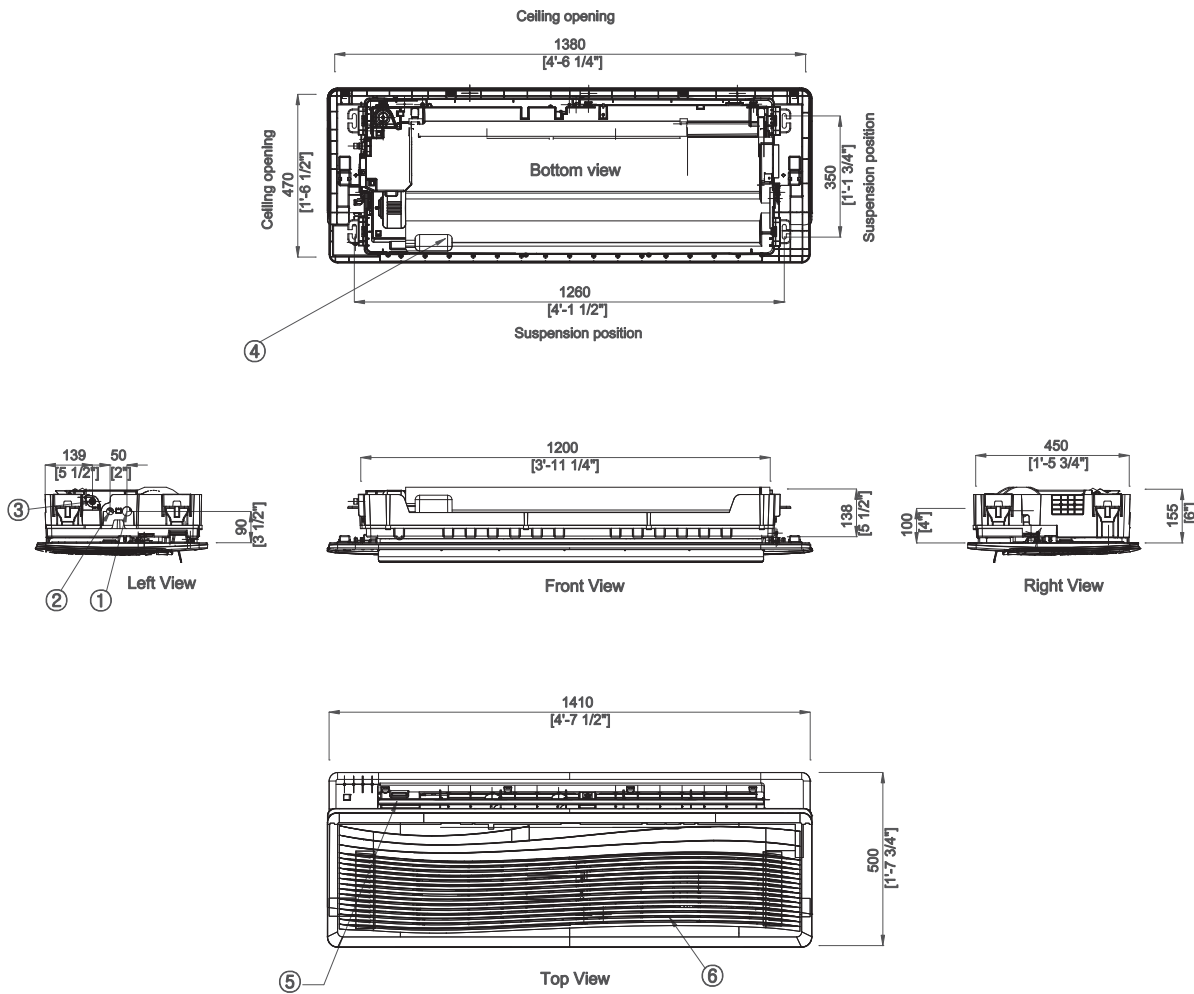

Table of descriptions

1	Refrigerant gas pipe	7	
2	Refrigerant liquid pipe	8	
3	Condensate drain	9	
4	Power & Comm. wiring conduits	10	
5	Air discharge louver	11	
6	Air suction grille	12	

4 Electrical wiring diagram

1Way Cassette

AM017HN1DEH/EU, AM022HN1DEH/EU, AM056JN1DEH/EU, AM071JN1DEH/EU

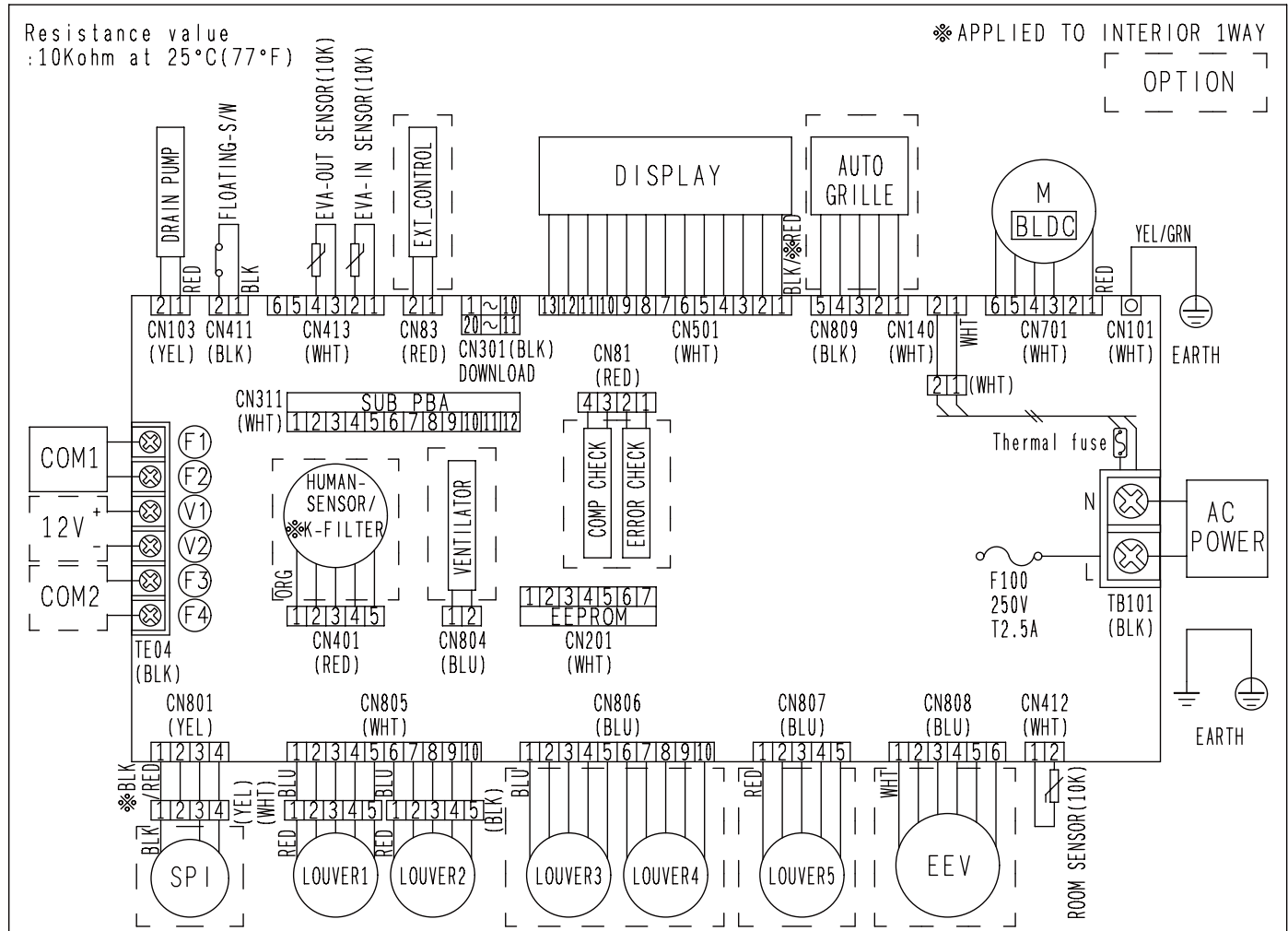

USE COPPER SUPPLY WIRES.
UTILISER DES FILS
D'ALIMENTATION EN CUIVRE.

E-PASS
DB68-03616B

LED LAMP DISPLAY					LED DISPLAY FOR ERROR DETECTION
OPERATION	DEFROST	TIMER	FAN	FILTER	
BLU	GRN	BLU	BLU	BLU	○ ON ● FLICKERING X OFF
X	X	●	X	X	ERROR OF TEMPERATURE SENSOR IN THE INDOOR UNIT(OPEN/SHORT)
●	X	●	X	X	ERROR OF EVA IN,OUT SENSOR IN THE INDOOR UNIT(OPEN/SHORT)
X	X	X	●	X	ERROR OF FAN MOTOR IN THE INDOOR UNIT
●	X	X	●	X	ERROR OF OUTDOOR SENSOR(OUTDOOR TEMP./COND/DISCHARGE)
X	X	●	●	X	NO COMMUNICATION FOR 2 MINUTES BETWEEN INDOOR AND OUTDOOR UNIT
X	X	●	●	●	ERROR OF OUTDOOR UNIT/SELF-DIAGNOSIS (CHECK ERROR CODE AT OUTDOOR UNIT'S OR SOLUTION DISPLAY)
X	X	X	●	●	DETECTION OF THE FLOAT SWITCH
●	X	●	●	●	EEPROM ERROR/EEPROM OPTION ERROR
X	X	X	X	●	NO MATCH BETWEEN OUTDOOR AND INDOOR

NOTE

- This wiring diagram applies only to the indoor unit.
- Symbols show as follow;
BLK : black, RED : red, BLU : blue, WHT:white, YEL : yellow, BRN : brown, SKY : sky-blue, GRN : green
- For connection wiring indoor-outdoor transmission F1-F2, indoor-wired remotecontroller transmission F3-F4.
- ⊕: Protective earth(screw), □□□□: Connector, n: The wire quantity

4 Electrical wiring diagram

1Way Cassette

AM022FN1DEH/EU, AM028FN1DEH/EU, AM036FN1DEH/EU

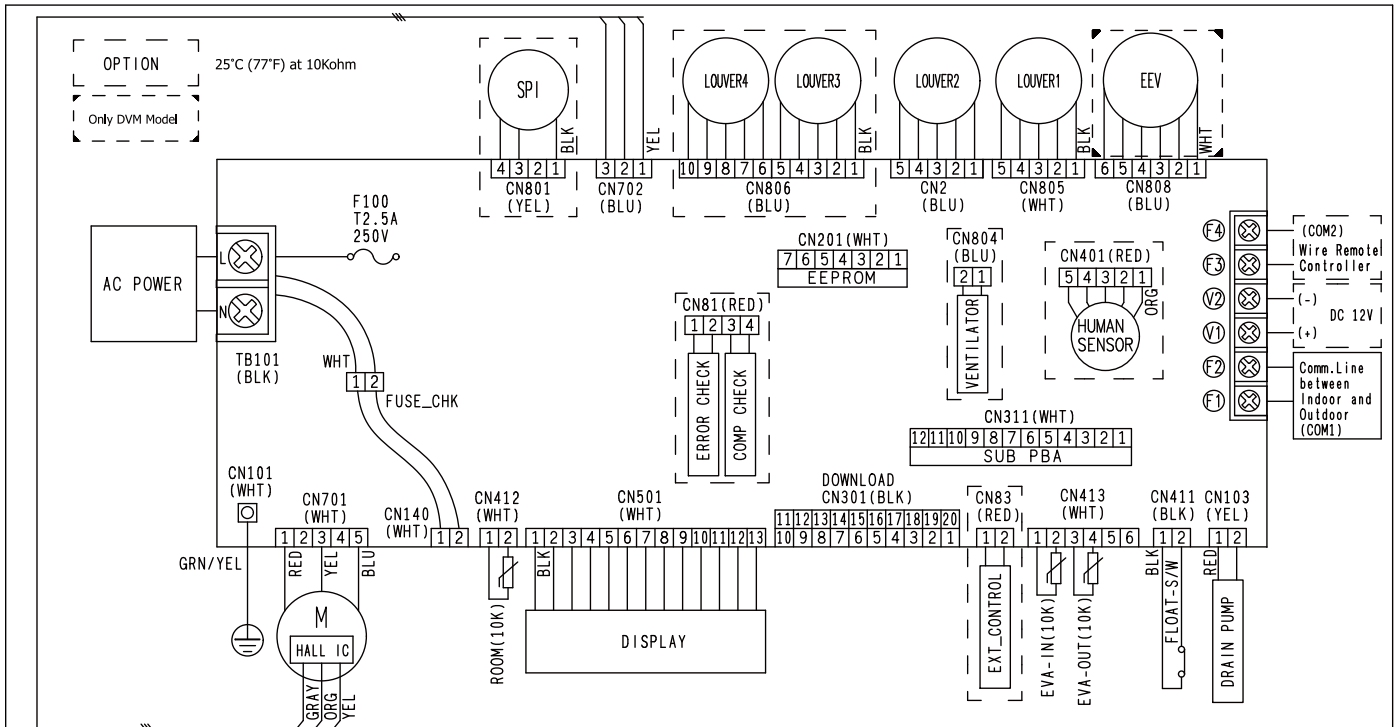

USE COPPER SUPPLY WIRES.

UTILISER DES FILS D'ALIMENTATION EN CUIVRE.

E-PASS
DB68-03609A

DB68-03609A

LED LAMP DISPLAY					LED DISPLAY FOR ERROR DETECTION
OPERATION	DEFROST	TIMER	FAN	FILTER	
<input type="checkbox"/>	<input type="checkbox"/>	<input type="checkbox"/>	<input type="checkbox"/>	<input type="checkbox"/>	ERROR OF ROOM TEMPERATURE SENSOR IN THE INDOOR UNIT (OPEN/SHORT)
<input type="checkbox"/>	<input type="checkbox"/>	<input type="checkbox"/>	<input type="checkbox"/>	<input type="checkbox"/>	ERROR OF EVA IN, OUT SENSOR IN THE INDOOR UNIT (OPEN/SHORT)
<input type="checkbox"/>	<input type="checkbox"/>	<input type="checkbox"/>	<input type="checkbox"/>	<input type="checkbox"/>	ERROR OF INDOOR FAN
<input type="checkbox"/>	<input type="checkbox"/>	<input type="checkbox"/>	<input type="checkbox"/>	<input type="checkbox"/>	ERROR OF OUTDOOR SENSOR (OUTDOOR TEMP/COND/DISCHARGE)
<input type="checkbox"/>	<input type="checkbox"/>	<input type="checkbox"/>	<input type="checkbox"/>	<input type="checkbox"/>	NO COMMUNICATION FOR 2MINUTES BETWEEN INDOOR AND OUTDOOR UNIT
<input type="checkbox"/>	<input type="checkbox"/>	<input type="checkbox"/>	<input type="checkbox"/>	<input type="checkbox"/>	ERROR OF OUTDOOR UNIT/SELF-DIAGNOSIS (Check error code at outdoor unit's or solution display)
<input type="checkbox"/>	<input type="checkbox"/>	<input type="checkbox"/>	<input type="checkbox"/>	<input type="checkbox"/>	DETECTION OF THE FLOAT SWITCH
<input type="checkbox"/>	<input type="checkbox"/>	<input type="checkbox"/>	<input type="checkbox"/>	<input type="checkbox"/>	EEPROM ERROR/EEPROM OPTION ERROR
<input type="checkbox"/>	<input type="checkbox"/>	<input type="checkbox"/>	<input type="checkbox"/>	<input type="checkbox"/>	NO MATCH BETWEEN OUTDOOR AND INDOOR (Only DVM Model)
<input type="checkbox"/>	<input type="checkbox"/>	<input type="checkbox"/>	<input type="checkbox"/>	<input type="checkbox"/>	HIGH PRESSURE BLOCKAGE ERROR (Only CAC Model)

NOTE

1. This wiring diagram applies only to the indoor unit.
2. Symbols show as follow;
BLK : black, RED : red, BLU : blue, WHT: white, YEL : yellow, BRN : brown, SKY : sky-blue, GRN : green
3. For connection wiring indoor-outdoor transmission F1-F2, indoor-wired remotecontroller transmission F3-F4.
4. : Protective earth (screw), : Connector, n : The wire quantity

5 Sound pressure level

1Way Cassette

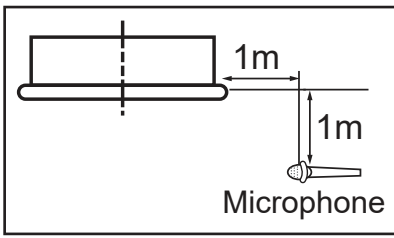

Model	Unit: dB(A)	
	High	Low
AM017HN1DEH/EU	27	21
AM022FN1DEH/EU	27	23
AM022HN1DEH/EU	27	23
AM028FN1DEH/EU	29	24

Note

Specifications may be subject to change without prior notice.
 Sound pressure level is obtained in an anechoic room.
 Sound pressure level is a relative value, depending on the distance and acoustic environment.
 Sound pressure level may differ depending on operation condition.
 dBA = A-weighted sound pressure level
 Reference acoustic pressure 0 dB= 20 uPa

NR curve

1) AM017HN1DEH/EU

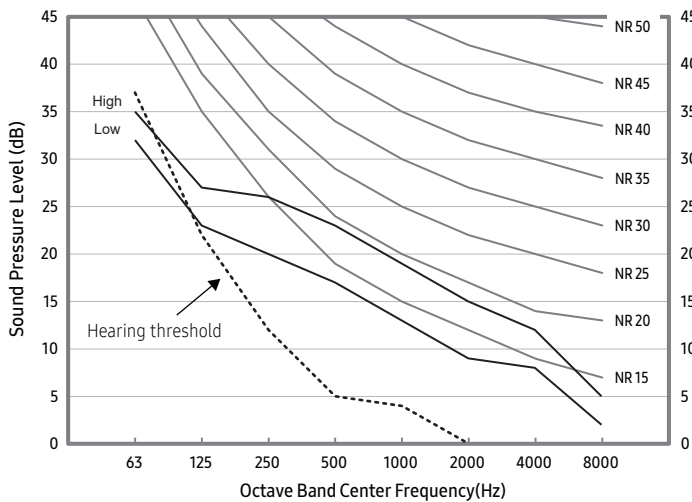

2) AM022FN1DEH/EU

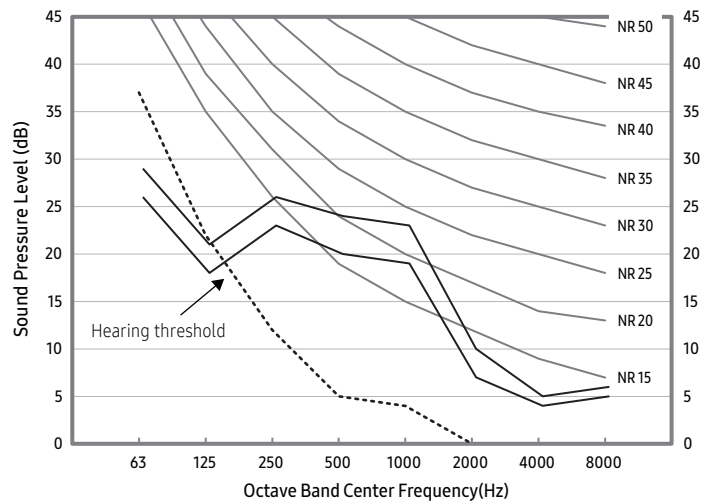

3) AM022HN1DEH/EU

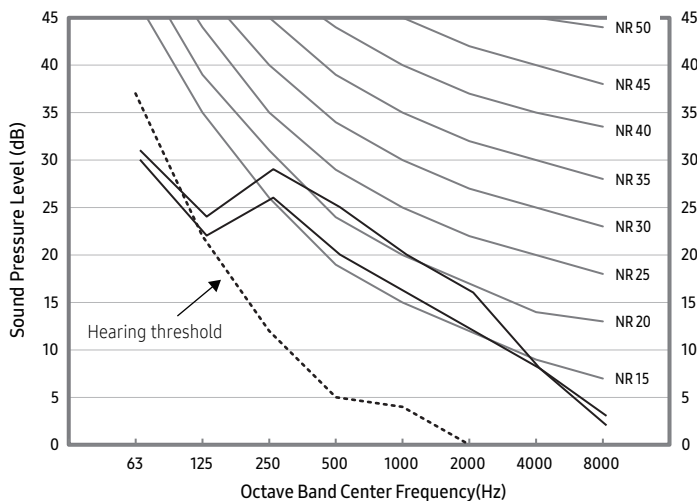

4) AM028FN1DEH/EU

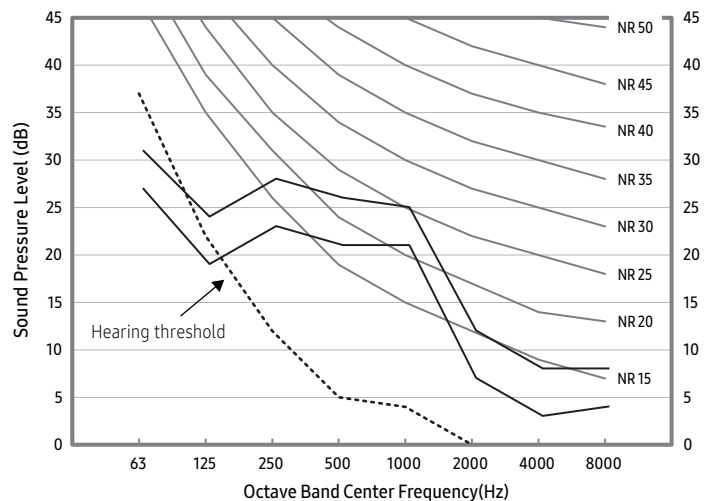

5 Sound pressure level

1Way Cassette

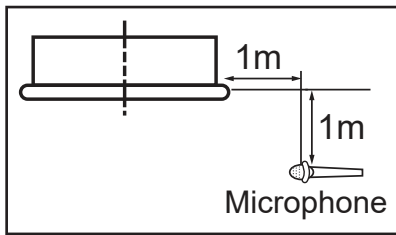

Model	Unit: dB(A)	
	High	Low
AM036FN1DEH/EU	35	27
AM056JN1DEH/EU	36	31
AM071JN1DEH/EU	39	34

Note

Specifications may be subject to change without prior notice.
 Sound pressure level is obtained in an anechoic room.
 Sound pressure level is a relative value, depending on the distance and acoustic environment.
 Sound pressure level may differ depending on operation condition.
 dBA = A-weighted sound pressure level
 Reference acoustic pressure 0 dB= 20 uPa

NR curve

1) AM036FN1DEH/EU

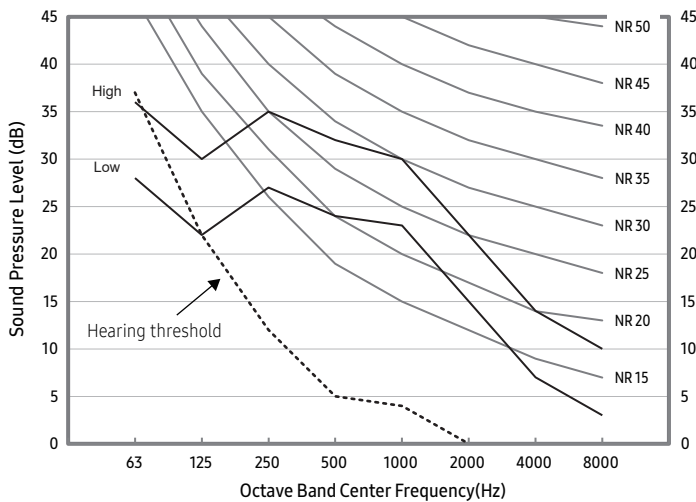

2) AM056JN1DEH/EU

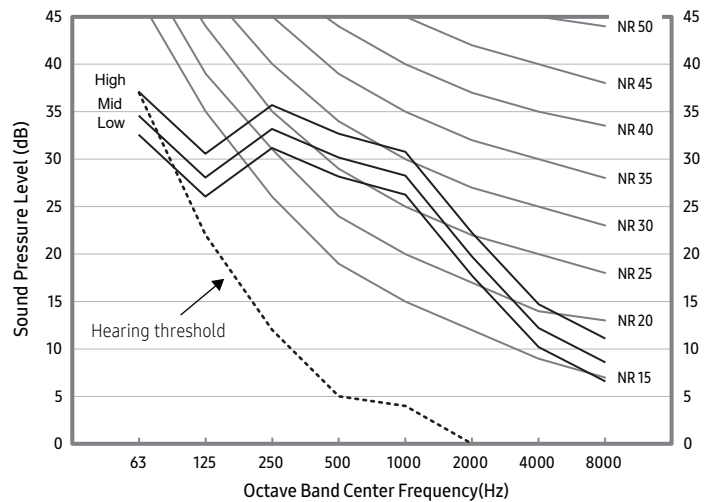

3) AM071JN1DEH/EU

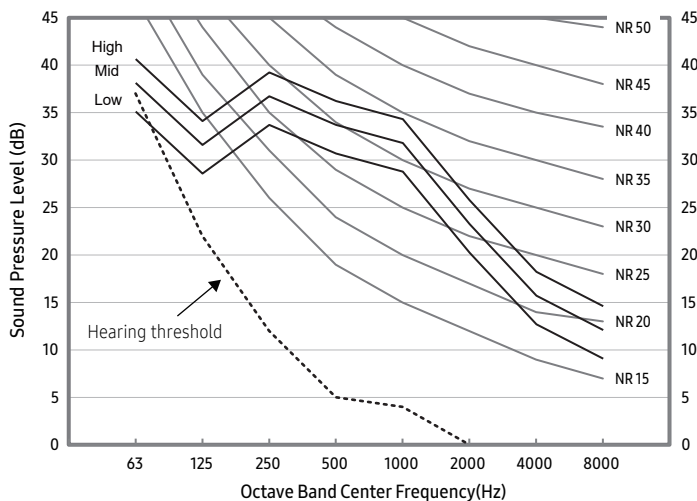

6 Sound power level

1Way Cassette

Note

- . Specifications may be subject to change without prior notice.
- . Sound power level is an absolute value that a sound source generates.
- . dBA = A-weighted sound power level.
- . Reference power : 1pW.
- . Measured according to ISO 3741

Unit: dB(A)

Model	Power
AM017HN1DEH/EU	43
AM022FN1DEH/EU	45
AM022HN1DEH/EU	46
AM028FN1DEH/EU	48

1)AM017HN1DEH/EU

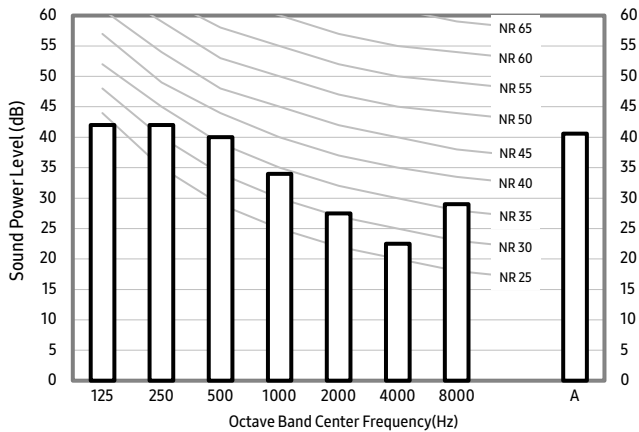

2)AM022FN1DEH/EU

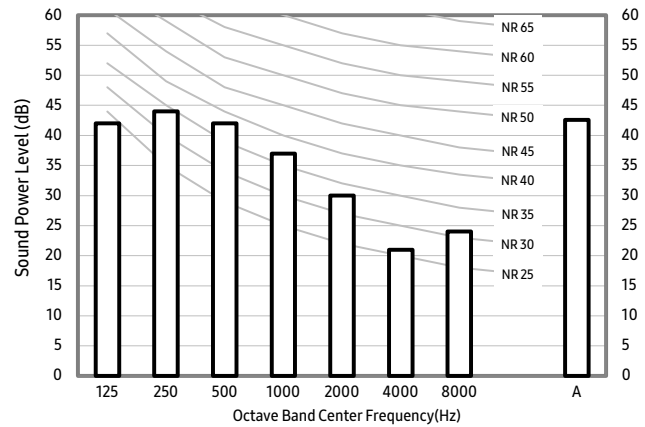

3)AM022HN1DEH/EU

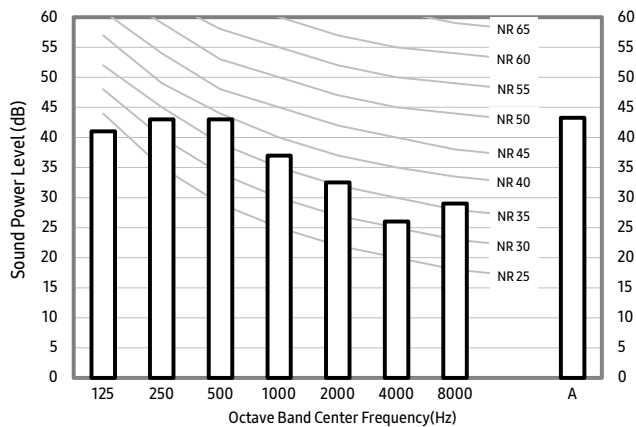

4)AM028FN1DEH/EU

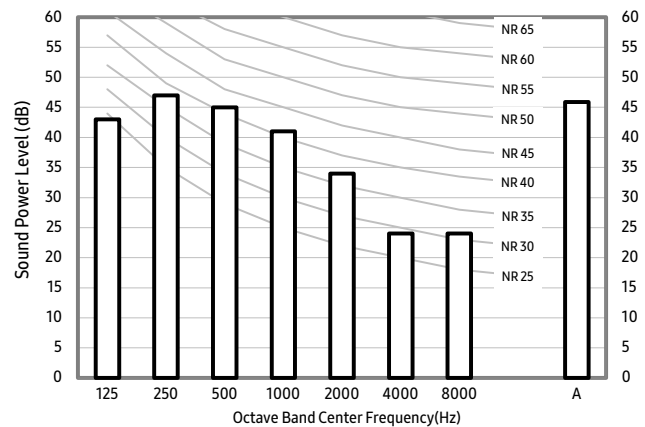

6 Sound power level

1Way Cassette

Note

- . Specifications may be subject to change without prior notice.
- . Sound power level is an absolute value that a sound source generates.
- . dBA = A-weighted sound power level.
- . Reference power : 1pW.
- . Measured according to ISO 3741

Unit: dB(A)

Model	Power
AM036FN1DEH/EU	52
AM056JN1DEH/EU	58
AM071JN1DEH/EU	60

1)AM036FN1DEH/EU

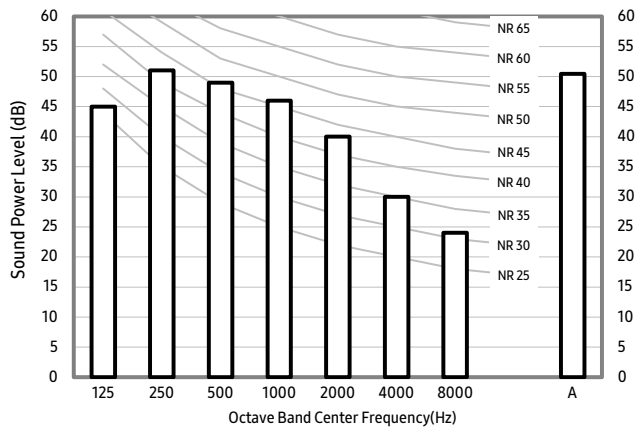

2)AM056JN1DEH/EU

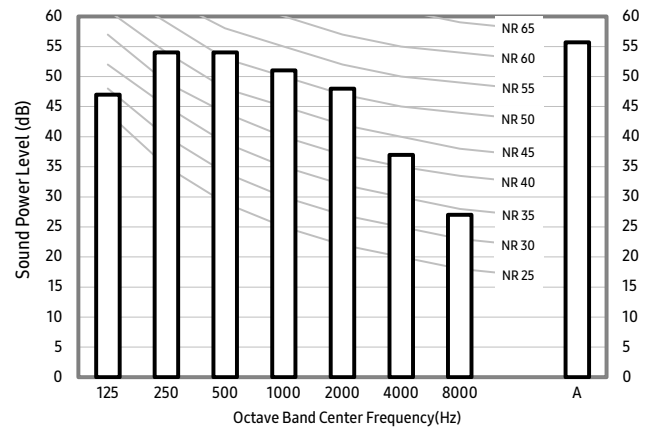

3)AM071JN1DEH/EU

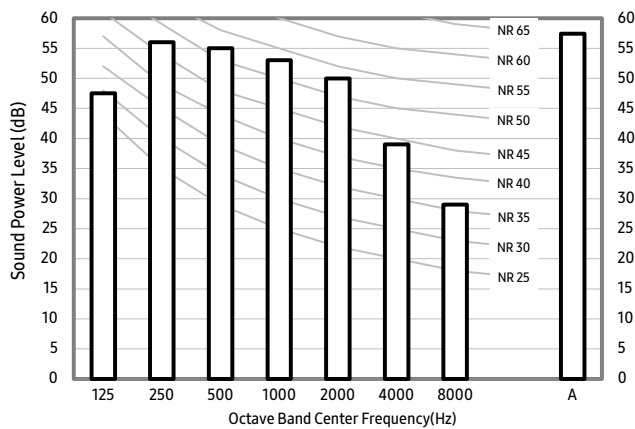

7 Temperature and air flow distribution

1 Way Cassette

AM036FN1DEH/EU

(1) Cooling air velocity distribution

Discharge angle : 60°

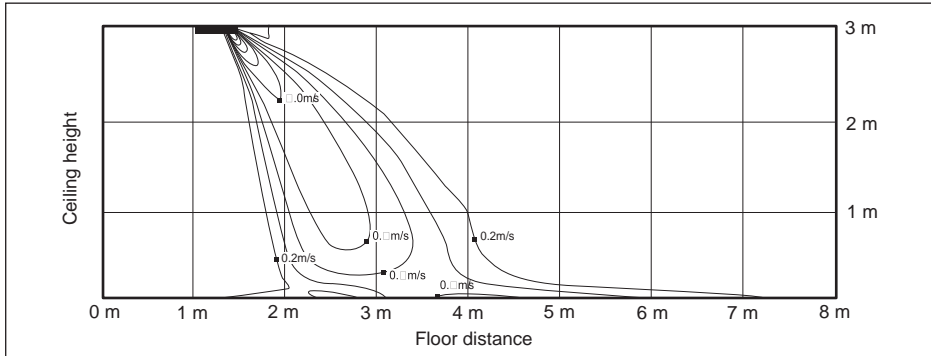

(2) Cooling temperature distribution

Discharge angle : 60°

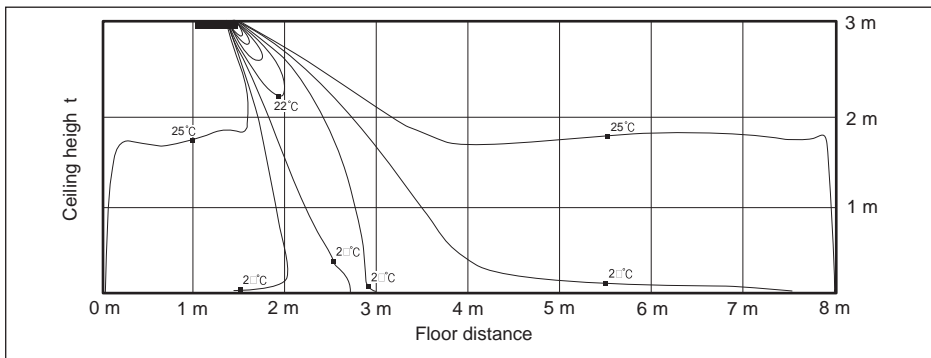

(3) Heating air velocity distribution

Discharge angle : 60°

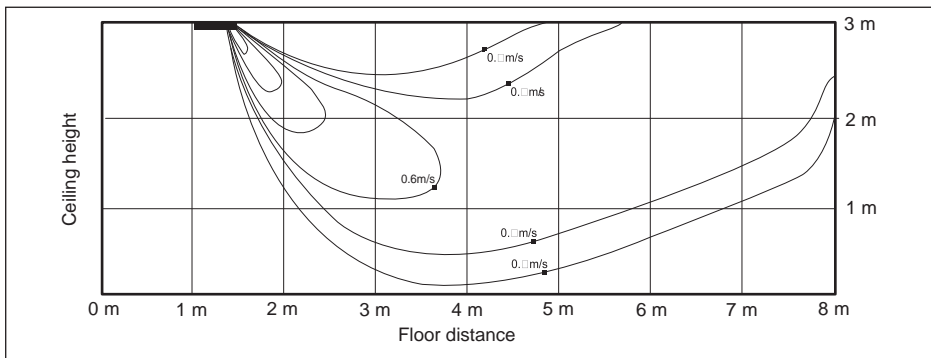

(4) Heating temperature distribution

Discharge angle : 60°

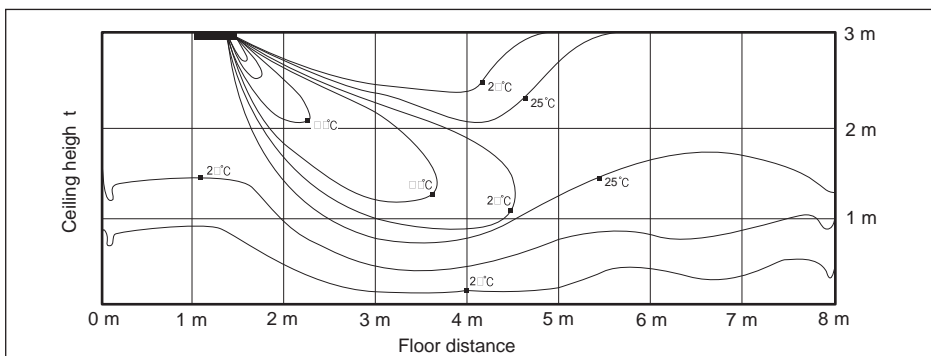

7 Temperature and air flow distribution

1 Way Cassette

AM056JN1DEH/EU

(1) Cooling air velocity distribution

Discharge angle : 50°

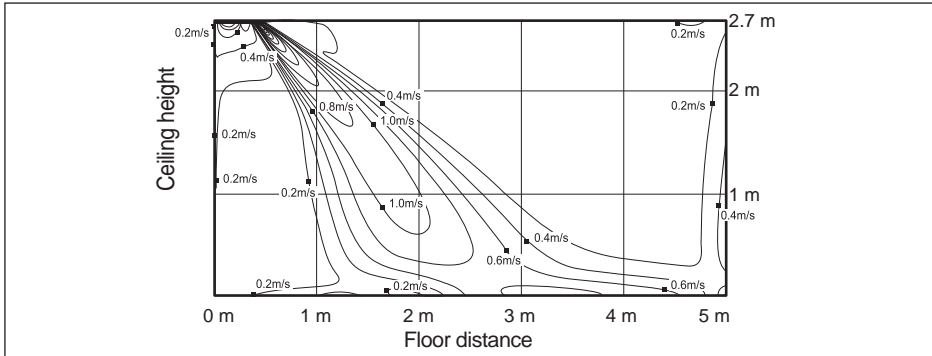

(2) Cooling temperature distribution

Discharge angle : 50°

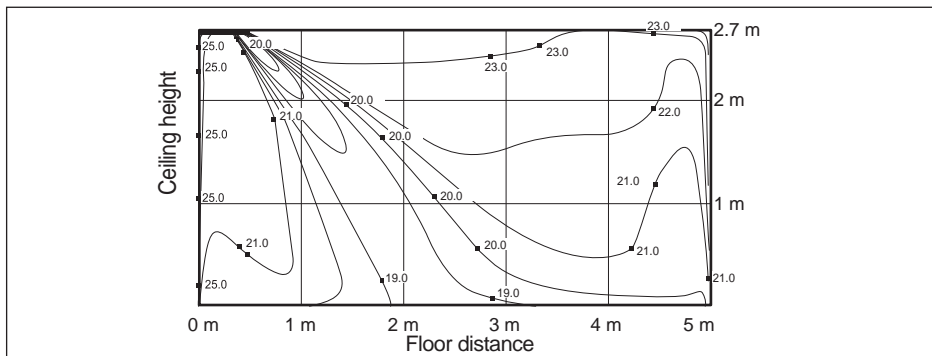

(3) Heating air velocity distribution

Discharge angle : 60°

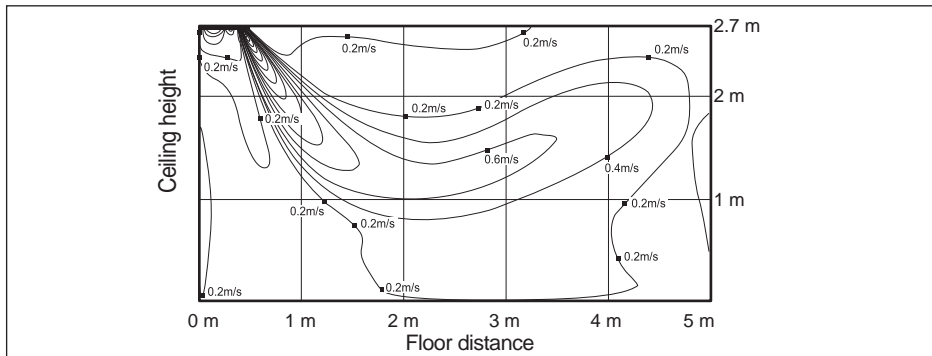

(4) Heating temperature distribution

Discharge angle : 60°

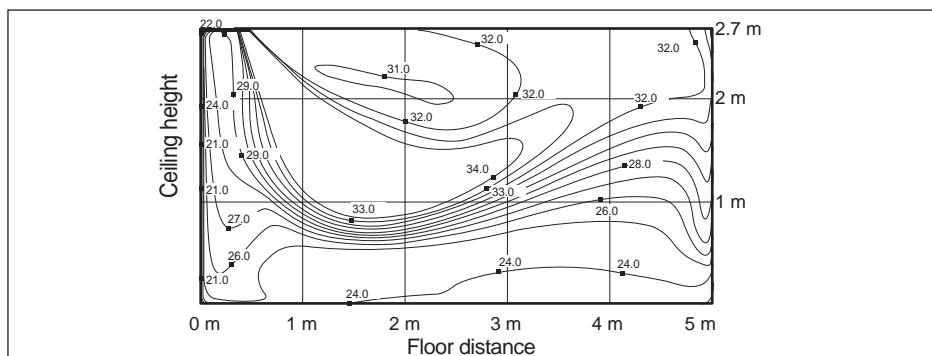

7 Temperature and air flow distribution

1 Way Cassette

AM071JN1DEH/EU

(1) Cooling air velocity distribution

Discharge angle : 50°

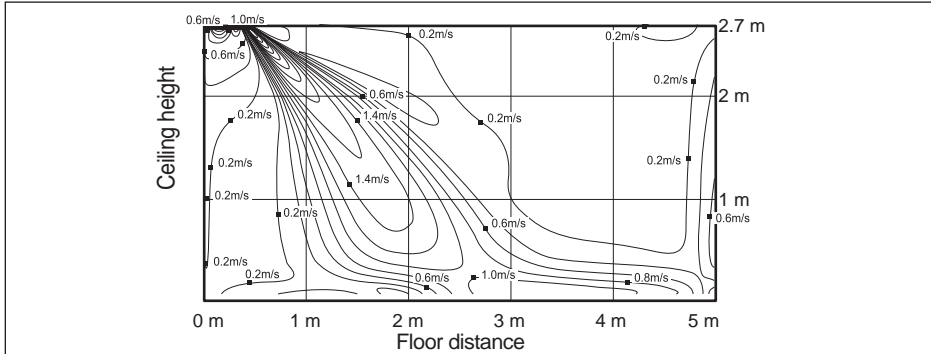

(2) Cooling temperature distribution

Discharge angle : 50°

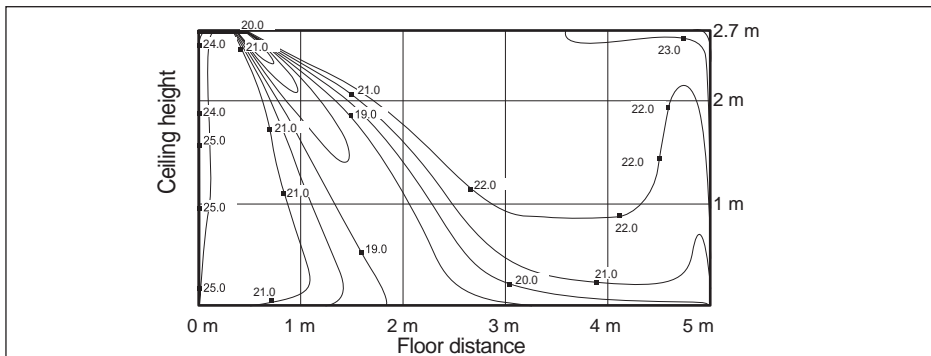

(3) Heating air velocity distribution

Discharge angle : 60°

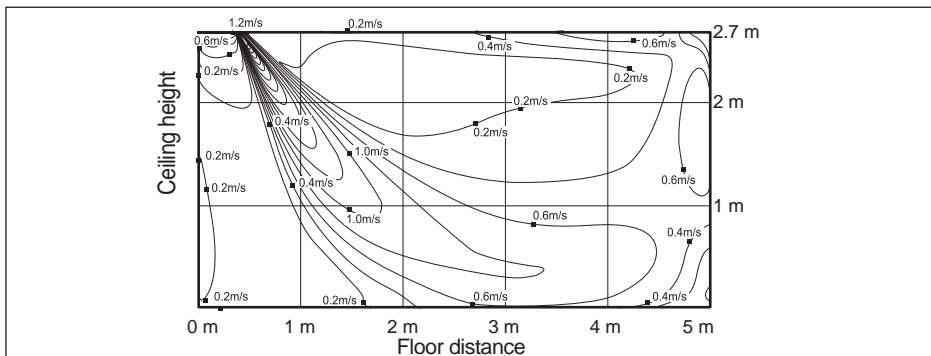

(4) Heating temperature distribution

Discharge angle : 60°

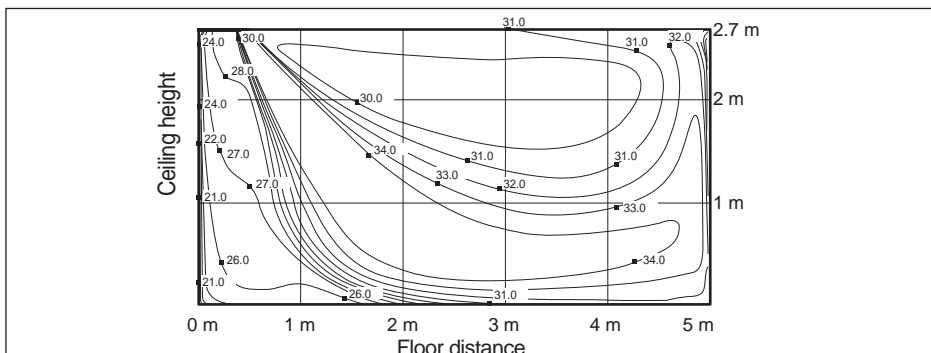

2Way Cassette

- 1 *Specifications*
- 2 *Capacity Table*
- 3 *Dimensional Drawing*
- 4 *Electrical Wiring Diagram*
- 5 *Sound Pressure Level*
- 6 *Temperature and air flow distribution*

1 Specifications

2Way Cassette

1) Technical specifications

Model				AM056FN2DEH***	AM071FN2DEH***	
Power Supply		Ø, #, V, Hz		1, 2, 220-240, 50	1, 2, 220-240, 50	
Mode* ¹⁾				HP/HR	HP/HR	
Performance	Capacity (Nominal)	Cooling* ²⁾	kW	5.6	7.1	
			Btu/h	19,100	24,200	
		Heating* ³⁾	kW	6.3	8.0	
			Btu/h	21,500	27,300	
Power	Power Input (Nominal)	Cooling* ²⁾	W	70	75	
		Heating* ³⁾	W	70	75	
	Current Input (Nominal)	Cooling* ²⁾	A	0.38	0.40	
		Heating* ³⁾	A	0.38	0.40	
Fan	Motor	Type	-	Crossflow Fan	Crossflow Fan	
		Output	W	14	14	
		Number of unit	EA	2	2	
	Air Flow Rate	H/M/L (UL)	CMM		14 / 13 / 12	15 / 14 / 13
			l/s		233.33/216.67/200.00	250.00/233.33/216.67
	External Pressure	Min / Std / Max	mmAq		-	-
			Pa		-	-
			WG		-	-
Option Code				012044-115561-203838-330010	012044-115582-204747-330010	
Piping Connections	Liquid Pipe	Ø, mm		6.35	9.52	
		Ø, inch		1/4	3/8	
	Gas Pipe	Ø, mm		12.70	15.88	
		Ø, inch		1/2	5/8	
Drain Pipe	Ø, mm		VP25 (OD 32, ID 25)	VP25 (OD 32, ID 25)		
Field Wiring	Power Source Wire	Below 20m / over 20m	mm ²	1.5 / 2.5	1.5 / 2.5	
	Transmission Cable		mm ²	0.75-1.5	0.75-1.5	
Refrigerant	Type		-	R410A	R410A	
	Control Method		-	EEV INCLUDED	EEV INCLUDED	
Sound	Sound Pressure	High / Mid / Low* ⁴⁾	dB(A)	38 / 37 / 35	41 / 39 / 37	
Dimensions	Net Weight		kg	21.00	22.00	
	Shipping Weight		kg	25.00	26.00	
	Net Dimensions (WxHxD)		mm	890 x 230 x 575	890 x 230 x 575	
	Shipping Dimensions (WxHxD)		mm	1,077 x 299 x 642	1,077 x 299 x 642	
Panel Size	Panel model		-	PC2NUSMEN	PC2NUSMEN	
	Panel Net Weight		kg	4.00	4.00	
	Shipping Weight		kg	8.00	8.00	
	Net Dimensions (WxHxD)		mm	1030 x 25 x 650	1030 x 25 x 650	
	Shipping Dimensions (WxHxD)		mm	1103 x 151 x 727	1103 x 151 x 727	
Additional Accessories	Drain pump	Drain pump	- / Model	Built-in	Built-in	
		Max. lifting Height / Displacement	mm/liter/h	750 / 24	750 / 24	
	Air Filter			-	Long life filter	Long life filter

* Specifications may be subject to change without prior notice for product improvement.

*1) Mode

- HP : Heat Pump, HR : Heat Recovery

*2) Nominal cooling capacities are based on;

- Indoor temperature : 27°C DB, 19°C WB

- Outdoor temperature : 35°C DB, 24°C WB, Equivalent refrigerant piping : 7.5m, Level differences : 0m

*3) Nominal heating capacities are based on;

- Indoor temperature : 20°C DB, 15°C WB

- Outdoor temperature : 7°C DB, 6°C WB, Equivalent refrigerant piping : 7.5m, Level differences : 0m

*4) Sound pressure was acquired in an anechoic room. Thus actual noise level may be different depending on the installation conditions.

*5) These products contain R410A which is fluorinated greenhouse gas.

* Heat Exchanger type : Fin & Tube (Fin : Al, Tube : Cu)

2 Capacity table

2Way Cassette

1) Cooling

TC : Total Capacity(kW), SHC : Sensible Heat Capacity(kW)

Capacity Index	Outdoor Air Temp. (°C, DB)	Indoor temperature													
		20(°C, DB)		23(°C, DB)		26(°C, DB)		27(°C, DB)		28(°C, DB)		30(°C, DB)		32(°C, DB)	
		14(°C, WB)		16(°C, WB)		18(°C, WB)		19(°C, WB)		20(°C, WB)		22(°C, WB)		24(°C, WB)	
		TC	SHC	TC	SHC	TC	SHC	TC	SHC	TC	SHC	TC	SHC	TC	SHC
056	10	3.9	3.2	4.6	3.5	5.3	3.9	5.6	3.9	5.8	3.9	6.3	3.9	6.7	3.7
	12	3.9	3.2	4.6	3.5	5.3	3.9	5.6	3.9	5.8	3.9	6.3	3.9	6.7	3.7
	14	3.9	3.2	4.6	3.5	5.3	3.9	5.6	3.9	5.8	3.9	6.2	3.8	6.7	3.7
	16	3.9	3.2	4.6	3.5	5.3	3.9	5.6	3.9	5.8	3.9	6.2	3.8	6.6	3.6
	18	3.9	3.2	4.6	3.5	5.3	3.9	5.6	3.9	5.8	3.9	6.2	3.8	6.6	3.6
	20	3.9	3.2	4.6	3.5	5.3	3.9	5.6	3.9	5.8	3.9	6.2	3.8	6.6	3.6
	21	3.9	3.2	4.6	3.5	5.3	3.9	5.6	3.9	5.8	3.9	6.2	3.8	6.6	3.6
	23	3.9	3.2	4.6	3.5	5.3	3.9	5.6	3.9	5.8	3.9	6.2	3.8	6.6	3.6
	25	3.9	3.2	4.6	3.5	5.3	3.9	5.6	3.9	5.8	3.9	6.2	3.8	6.6	3.6
	27	3.9	3.2	4.6	3.5	5.3	3.9	5.6	3.9	5.8	3.9	6.2	3.8	6.6	3.6
	29	3.9	3.2	4.6	3.5	5.3	3.9	5.6	3.9	5.8	3.9	6.2	3.8	6.6	3.6
	31	3.9	3.2	4.6	3.5	5.3	3.9	5.6	3.9	5.8	3.9	6.2	3.8	6.6	3.6
	33	3.9	3.2	4.6	3.5	5.3	3.9	5.6	3.9	5.8	3.9	6.2	3.8	6.6	3.6
	35	3.9	3.2	4.6	3.5	5.3	3.9	5.6	3.9	5.8	3.9	6.2	3.8	6.6	3.6
	37	3.9	3.2	4.6	3.5	5.3	3.9	5.6	3.9	5.8	3.9	6.2	3.8	6.6	3.5
	39	3.9	3.2	4.6	3.5	5.3	3.9	5.6	3.9	5.8	3.9	6.2	3.8	6.6	3.4
42	3.9	3.2	4.6	3.5	5.3	3.9	5.5	3.8	5.7	3.9	6.1	3.7	6.4	3.3	
44	3.9	3.2	4.6	3.5	5.1	3.8	5.3	3.7	5.6	3.7	5.9	3.6	6.2	3.2	
46	3.9	3.2	4.6	3.5	5.0	3.7	5.2	3.6	5.4	3.6	5.7	3.5	6.0	3.1	
48	3.9	3.2	4.5	3.4	5.0	3.6	5.0	3.5	5.3	3.6	5.5	3.4	5.8	3.0	
071	10	4.9	4.0	5.8	4.5	6.7	4.8	7.1	5.0	7.4	5.0	8.0	5.1	8.5	4.8
	12	4.9	4.0	5.8	4.5	6.7	4.8	7.1	5.0	7.4	5.0	7.9	5.0	8.5	4.8
	14	4.9	4.0	5.8	4.5	6.7	4.8	7.1	5.0	7.4	5.0	7.9	5.0	8.5	4.8
	16	4.9	4.0	5.8	4.5	6.7	4.8	7.1	5.0	7.4	5.0	7.9	5.0	8.4	4.8
	18	4.9	4.0	5.8	4.5	6.7	4.8	7.1	5.0	7.4	5.0	7.9	5.0	8.4	4.8
	20	4.9	4.0	5.8	4.5	6.7	4.8	7.1	5.0	7.4	5.0	7.9	5.0	8.4	4.8
	21	4.9	4.0	5.8	4.5	6.7	4.8	7.1	5.0	7.4	5.0	7.9	5.0	8.4	4.8
	23	4.9	4.0	5.8	4.5	6.7	4.8	7.1	5.0	7.4	5.0	7.9	5.0	8.4	4.8
	25	4.9	4.0	5.8	4.5	6.7	4.8	7.1	5.0	7.4	5.0	7.9	5.0	8.4	4.8
	27	4.9	4.0	5.8	4.5	6.7	4.8	7.1	5.0	7.4	5.0	7.9	5.0	8.4	4.8
	29	4.9	4.0	5.8	4.5	6.7	4.8	7.1	5.0	7.4	5.0	7.9	5.0	8.4	4.8
	31	4.9	4.0	5.8	4.5	6.7	4.8	7.1	5.0	7.4	5.0	7.9	5.0	8.4	4.8
	33	4.9	4.0	5.8	4.5	6.7	4.8	7.1	5.0	7.4	5.0	7.9	5.0	8.4	4.8
	35	4.9	4.0	5.8	4.5	6.7	4.8	7.1	5.0	7.4	5.0	7.9	5.0	8.4	4.8
	37	4.9	4.0	5.8	4.5	6.7	4.8	7.1	5.0	7.3	4.9	7.8	4.9	8.2	4.7
	39	4.9	4.0	5.8	4.5	6.7	4.8	7.1	5.0	7.3	4.9	7.7	4.8	8.1	4.6
42	4.9	4.0	5.8	4.5	6.7	4.8	7.0	4.9	7.2	4.8	7.6	4.7	7.9	4.5	
44	4.9	4.0	5.8	4.5	6.5	4.6	6.8	4.8	7.0	4.7	7.3	4.5	7.6	4.3	
46	4.9	4.0	5.7	4.5	6.4	4.6	6.6	4.6	6.8	4.6	7.0	4.4	7.4	4.2	
48	4.8	3.9	5.7	4.4	6.3	4.5	6.4	4.5	6.7	4.5	6.8	4.3	7.2	4.1	

2 Capacity table

2Way Cassette

2) Heating

TC : Total Capacity(kW)

Capacity Index	Outdoor Air Temp. (°C)		Indoor temperature (°C,DB)				
			16(°C,DB)	18(°C,DB)	20(°C,DB)	22(°C,DB)	24(°C,DB)
	DB	WB	TC kW	TC kW	TC kW	TC kW	TC kW
056	-19.8	-20.0	3.9	3.8	3.8	3.7	3.7
	-18.8	-19.0	3.9	3.9	3.8	3.7	3.7
	-16.7	-17.0	4.0	4.0	3.9	3.8	3.8
	-14.7	-15.0	4.2	4.1	4.0	3.9	3.8
	-12.6	-13.0	4.4	4.3	4.2	4.1	4.0
	-10.5	-11.0	4.6	4.5	4.4	4.4	4.3
	-9.5	-10.0	4.7	4.6	4.6	4.5	4.4
	-8.5	-9.1	4.8	4.7	4.7	4.6	4.5
	-7.0	-7.6	4.9	4.8	4.8	4.7	4.5
	-5.0	-5.6	5.2	5.1	5.0	4.9	4.7
	-3.0	-3.7	5.4	5.3	5.3	5.1	4.9
	0.0	-0.7	5.7	5.6	5.5	5.3	5.0
	3.0	2.2	5.9	5.9	5.8	5.6	5.3
	5.0	4.1	6.2	6.1	6.0	5.7	5.3
	7.0	6.0	6.5	6.4	6.3	5.8	5.3
9.0	7.9	6.7	6.5	6.3	5.8	5.3	
11.0	9.8	6.9	6.6	6.3	5.8	5.3	
13.0	11.8	7.1	6.7	6.3	5.8	5.3	
15.0	13.7	7.3	6.8	6.3	5.8	5.3	
071	-19.8	-20.0	4.9	4.9	4.8	4.7	4.7
	-18.8	-19.0	5.0	4.9	4.8	4.7	4.7
	-16.7	-17.0	5.1	5.0	4.9	4.8	4.8
	-14.7	-15.0	5.3	5.2	5.1	4.9	4.8
	-12.6	-13.0	5.5	5.4	5.3	5.2	5.1
	-10.5	-11.0	5.8	5.7	5.6	5.5	5.5
	-9.5	-10.0	6.0	5.9	5.8	5.7	5.6
	-8.5	-9.1	6.1	6.0	5.9	5.8	5.7
	-7.0	-7.6	6.2	6.1	6.0	5.9	5.8
	-5.0	-5.6	6.5	6.5	6.4	6.2	6.0
	-3.0	-3.7	6.9	6.8	6.7	6.4	6.2
	0.0	-0.7	7.2	7.1	7.0	6.7	6.4
	3.0	2.2	7.6	7.5	7.3	7.1	6.8
	5.0	4.1	7.9	7.8	7.7	7.2	6.8
	7.0	6.0	8.2	8.1	8.0	7.4	6.8
9.0	7.9	8.5	8.2	8.0	7.4	6.8	
11.0	9.8	8.7	8.4	8.0	7.4	6.8	
13.0	11.8	9.0	8.5	8.0	7.4	6.8	
15.0	13.7	9.2	8.6	8.0	7.4	6.8	

3 Dimensional drawing

2Way Cassette

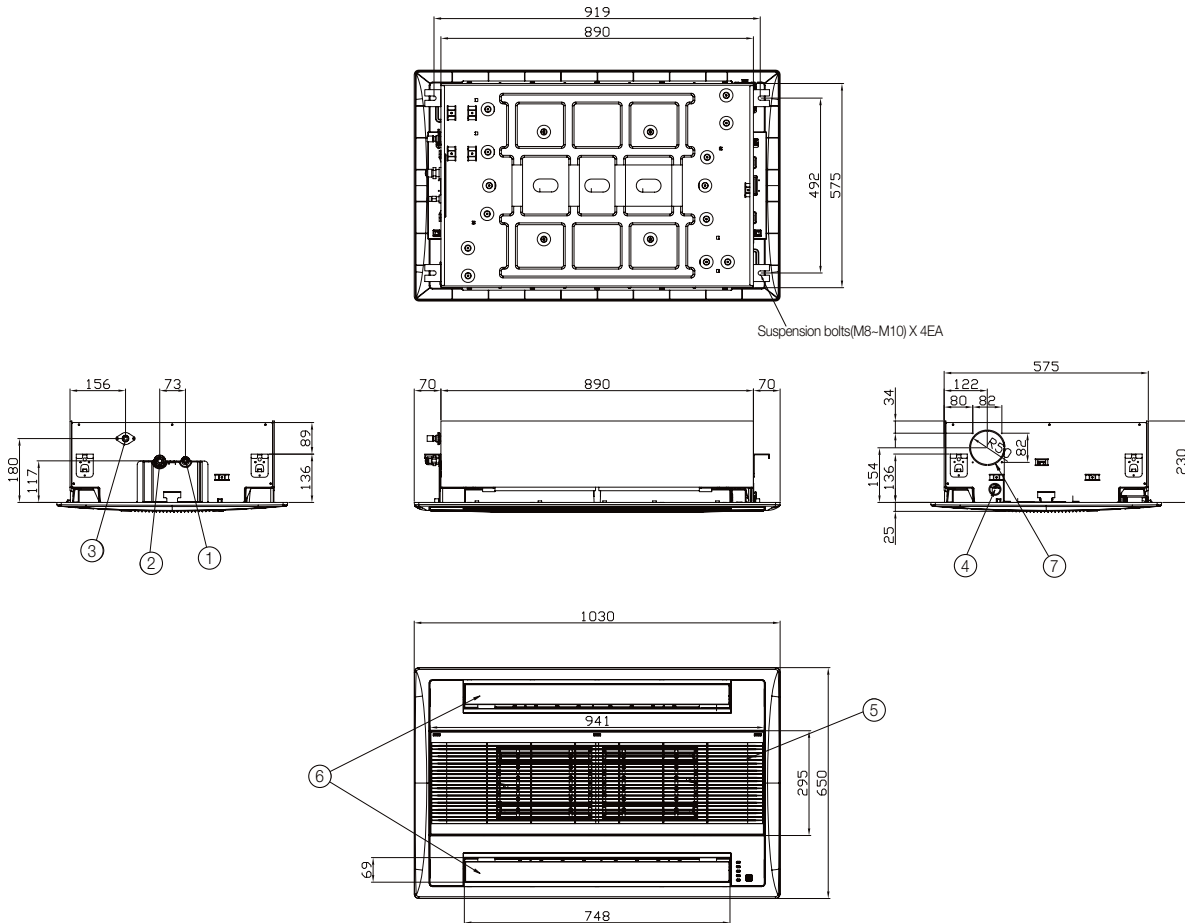

No.	Name	Description	
		5.6kW	7.1kW
①	Liquid pipe connection	Ø6.35 Flare	Ø9.52 Flare
②	Gas pipe connection	Ø12.70 Flare	Ø15.88 Flare
③	Drain pipe connection	VP25 (OD 32, ID 25)	
④	Conduit for power supply & communication wiring	-	
⑤	Air inlet grille	-	
⑥	Air outlet louver	-	
⑦	Fresh air intake	-	

4 Electrical wiring diagram

2Way Cassette

AM056FN2DEH/EU, AM071FN2DEH/EU

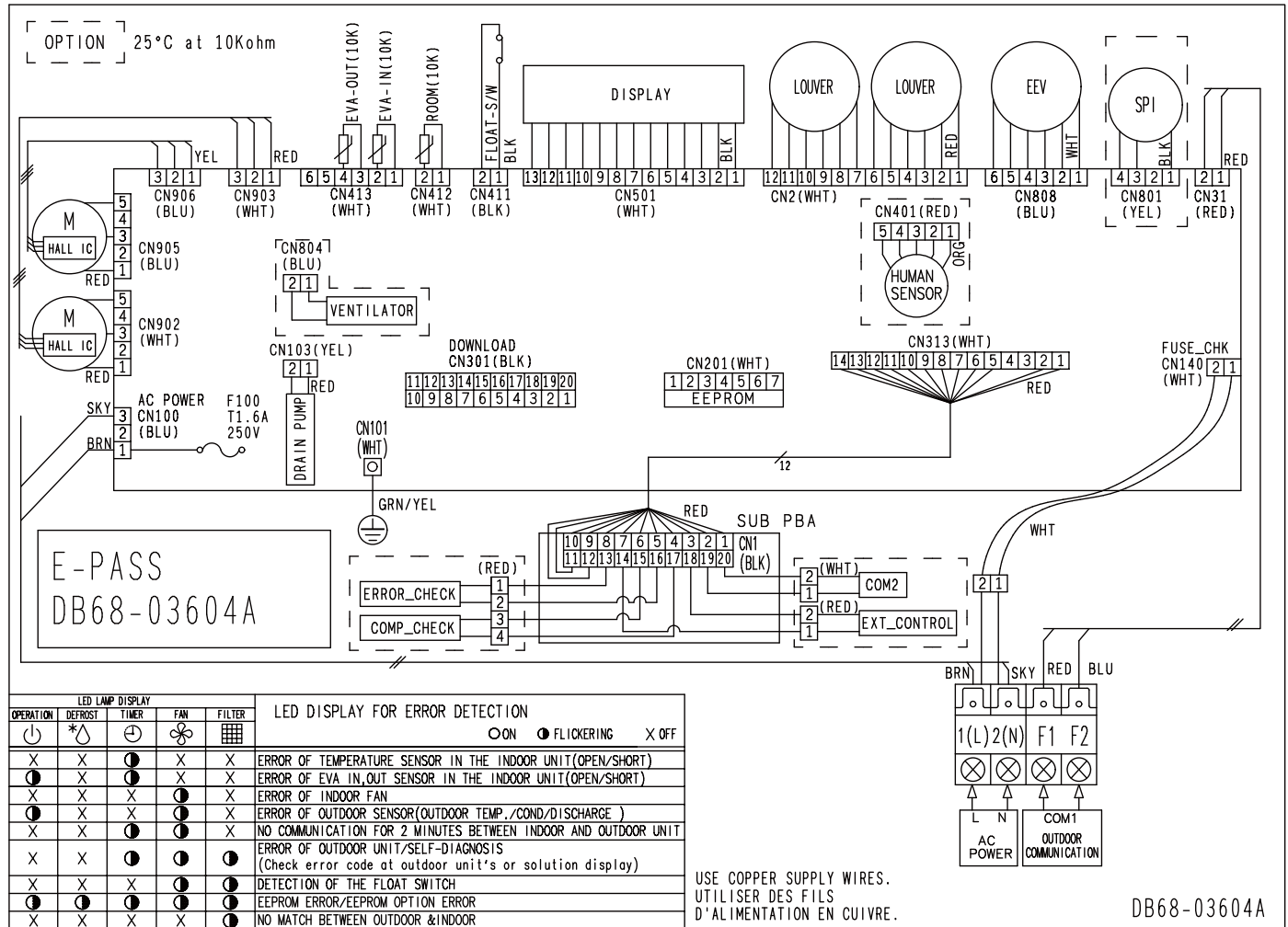

NOTE

1. This wiring diagram applies only to the indoor unit.
2. Symbols show as follow;
BLK : black, RED : red, BLU : blue, WHT:white, YEL : yellow, BRN : brown, SKY : sky-blue, GRN : green
3. For connection wiring indoor-outdoor transmission F1-F2, indoor-wired remotecontroller transmission F3-F4.
4. : Protective earth(screw), : Connector, n : The wire quantity

5 Sound pressure level

2Way Cassette

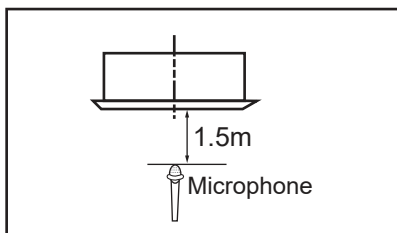

Unit: dB(A)

Model	High	Low
AM056FN2DEH/EU	38	35
AM071FN2DEH/EU	41	37

Note

Specifications may be subject to change without prior notice.
 Sound pressure level is obtained in an anechoic room.
 Sound pressure level is a relative value, depending on the distance and acoustic environment.
 Sound pressure level may differ depending on operation condition.
 dBA = A-weighted sound pressure level
 Reference acoustic pressure 0 dB= 20 uPa

NR curve

1) AM056FN2DEH/EU

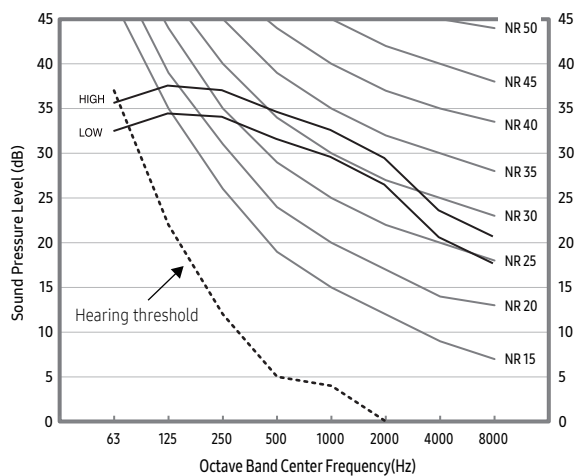

2) AM071FN2DEH/EU

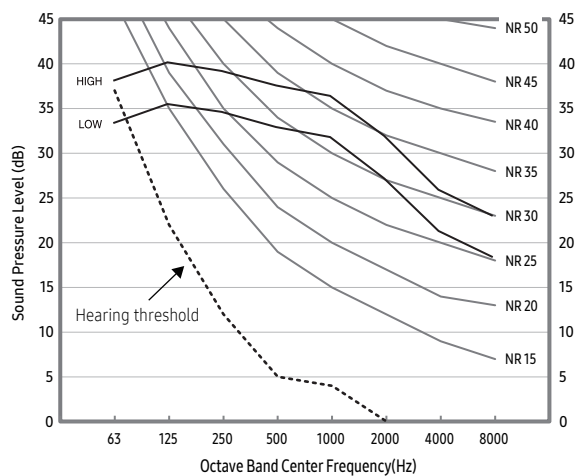

6 Temperature and air flow distribution

2Way Cassette

AM071FN2DEH/EU

(1) Cooling air velocity distribution

Discharge angle : 54°

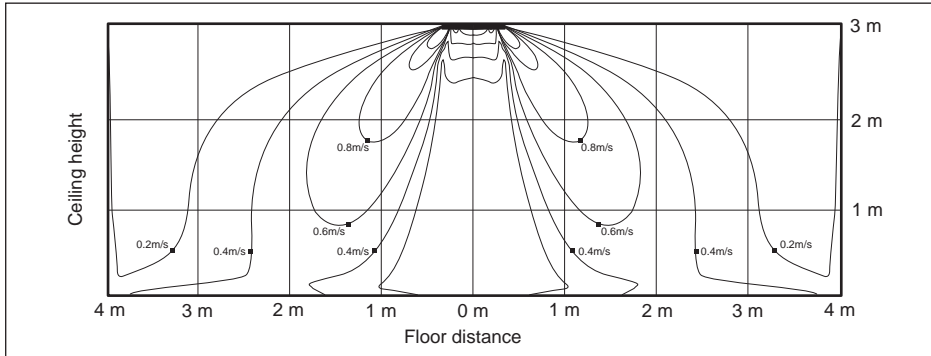

(2) Cooling temperature distribution

Discharge angle : 54°

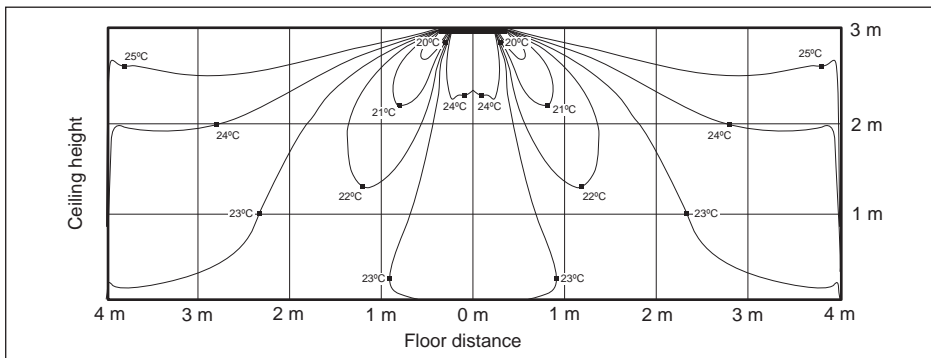

(3) Heating air velocity distribution

Discharge angle : 54°

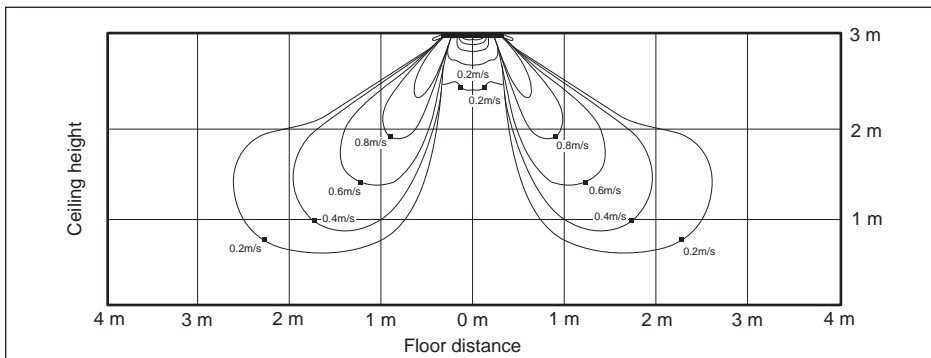

(4) Heating temperature distribution

Discharge angle : 54°

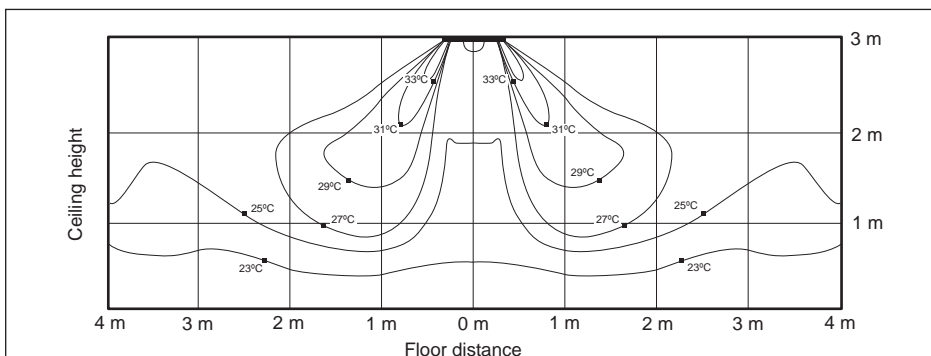

4Way Cassette S(600x600)

- 1 *Specifications*
- 2 *Capacity Table*
- 3 *Dimensional Drawing*
- 4 *Electrical Wiring Diagram*
- 5 *Sound Pressure Level*
- 6 *Sound Power Level*
- 7 *Temperature and air flow distribution*

1 Specifications

4Way Cassette S (600 x 600)

Type			4Way Cassette (600 x 600)		4Way Cassette (600 x 600)	
Model			AM015HNNDEH/EU		AM022FNNDEH/EU	
Power Supply			Ø, #, V, Hz	1,2,220-240,50	1,2,220-240,50	
Mode			-		HP/HR	
Performance	Capacity (Nominal)	Cooling	kW	1.50	2.20	
			Btu/h	5,100	7,500	
		Heating	kW	1.70	2.50	
			Btu/h	5,800	8,500	
Power	Power Input (Nominal)	Cooling	W	18.00	18.00	
		Heating	W	18.00	18.00	
	Current Input (Nominal)	Cooling	A	0.17	0.17	
		Heating	A	0.17	0.17	
Fan	Motor	Type	-	Turbo Fan		
		Output x n	w	65 x 1		
	Air Flow Rate	H/M/L (UL)	CMM	8.20 / 7.00 / 6.30	9.00 / 7.70 / 6.50	
			l/s	136.67 / 116.67 / 105.00	150.00 / 128.33 / 108.33	
	External Pressure	Min/Std/Max	mmAq	-	-	
Pa			-	-		
Piping Connections	Liquid Pipe	Ø, mm	6.35	6.35		
		Ø, inch	1/4"	1/4"		
	Gas Pipe	Ø, mm	12.70	12.70		
		Ø, inch	1/2"	1/2"		
Drain Pipe	Ø, mm	VP25 (OD 32,ID 25)	VP25 (OD 32,ID 25)			
Field Wiring	Power Source Wire	mm ²	1.5 - 2.5	1.5 - 2.5		
	Transmission Cable	mm ²	0.75 - 1.50	0.75 - 1.50		
Refrigerant	Type	-	R410A			
	Control Method	-	EEV(O)			
Sound	Pressure	High / Mid / Low	dB(A)	30 / 28 / 23		
	Power	Cooling		46		
Dimension	Net Weight		kg	12.00	12.00	
	Shipping Weight		kg	14.00	14.00	
	Net Dimensions (WxHxD)		mm	575 x 250 x 575	575 x 250 x 575	
	Shipping Dimensions (WxHxD)		mm	623 x 298 x 653	623 x 298 x 653	
Panel Size	Panel model		-	PC4SUSMBN		
	Panel Net Weight		kg	2.3	2.3	
	Shipping Weight		kg	3.5	3.5	
	Net Dimensions (WxHxD)		mm	620 x 45 x 620	620 x 45 x 620	
	Shipping Dimensions (WxHxD)		mm	661 x 106 x 671	661 x 106 x 671	
Additional Accessories	Drain Pump	Drain Pump	- / Model	-		
		Max. lifting Height / Displacement	mm/liter/h	-		
	Air Filter		-	-		

- Mode : HP(Heat Pump), HR(Heat Recovery)

- Nominal Cooling : Indoor temperature 27 °CDB / 19 °CWB, Outdoor temperature 35 °CDB/24 °CWB, Refrigerant pipe length 7.5m, Level difference 0m.

- Nominal Heating : Indoor temperature 20 °CDB/15 °CWB, Outdoor temperature 7 °CDB / 6 °CWB, Refrigerant pipe length 7.5m, Level difference 0m.

- Sound level was acquired in an anechoic room. Thus actual noise level may be different depending on the installation conditions.

- These products contain R410A which is fluorinated greenhouse gas.

- Specifications may be subject to change without prior notice.

* Heat Exchanger type : Fin & Tube (Fin : Al, Tube : Cu)

1 Specifications

4Way Cassette S (600 x 600)

Type			4Way Cassette (600 x 600)		4Way Cassette (600 x 600)	
Model			AM028FNNDH/EU		AM036FNNDH/EU	
Power Supply			Ø, #, V, Hz	1,2,220-240,50	1,2,220-240,50	
Mode			-	HP/HR	HP/HR	
Performance	Capacity (Nominal)	Cooling	kW	2.80	3.60	
			Btu/h	9,600	12,300	
		Heating	kW	3.20	4.00	
			Btu/h	10,900	13,600	
Power	Power Input (Nominal)	Cooling	W	18.00	20.00	
		Heating	W	18.00	20.00	
	Current Input (Nominal)	Cooling	A	0.17	0.19	
		Heating	A	0.17	0.19	
Fan	Motor	Type	-	Turbo Fan	Turbo Fan	
		Output x n	w	65 x 1	65 x 1	
	Air Flow Rate	H/M/L (UL)	CMM	10.00 / 8.50 / 7.50	10.50 / 9.50 / 8.00	
			l/s	166.67 / 141.67 / 125.00	175.00 / 158.33 / 133.33	
	External Pressure	Min/Std/Max	mmAq	-	-	
Pa			-	-		
Piping Connections	Liquid Pipe	Ø, mm	6.35	6.35		
		Ø, inch	1/4"	1/4"		
	Gas Pipe	Ø, mm	12.70	12.70		
		Ø, inch	1/2"	1/2"		
	Drain Pipe	Ø, mm	VP25 (OD 32,ID 25)	VP25 (OD 32,ID 25)		
Field Wiring	Power Source Wire	mm ²	1.5 - 2.5	1.5 - 2.5		
	Transmission Cable	mm ²	0.75 - 1.50	0.75 - 1.50		
Refrigerant	Type	-	R410A	R410A		
	Control Method	-	EEV(O)	EEV(O)		
Sound	Pressure	High / Mid / Low	dB(A)	33 / 30 / 26		
	Power	Cooling		50		
Dimension	Net Weight		kg	12.00	12.00	
	Shipping Weight		kg	14.00	14.00	
	Net Dimensions (WxHxD)		mm	575 x 250 x 575	575 x 250 x 575	
	Shipping Dimensions (WxHxD)		mm	623 x 298 x 653	623 x 298 x 653	
Panel Size	Panel model		-	PC4SUSMBN	PC4SUSMBN	
	Panel Net Weight		kg	2.3	2.3	
	Shipping Weight		kg	3.5	3.5	
	Net Dimensions (WxHxD)		mm	620 x 45 x 620	620 x 45 x 620	
	Shipping Dimensions (WxHxD)		mm	661 x 106 x 671	661 x 106 x 671	
Additional Accessories	Drain Pump	Drain Pump	- / Model	-	-	
		Max. lifting Height / Displacement	mm/liter/h	-	-	
	Air Filter		-	-	-	

- Mode : HP(Heat Pump), HR(Heat Recovery)

- Nominal Cooling : Indoor temperature 27°CDB / 19°CWB, Outdoor temperature 35°CDB/24°CWB, Refrigerant pipe length 7.5m, Level difference 0m.

- Nominal Heating : Indoor temperature 20°CDB/15°CWB, Outdoor temperature 7°CDB / 6°CWB, Refrigerant pipe length 7.5m, Level difference 0m.

- Sound level was acquired in an anechoic room. Thus actual noise level may be different depending on the installation conditions.

- These products contain R410A which is fluorinated greenhouse gas.

- Specifications may be subject to change without prior notice.

* Heat Exchanger type : Fin & Tube (Fin : Al, Tube : Cu)

1 Specifications

4Way Cassette S (600 x 600)

Type			4Way Cassette (600 x 600)		4Way Cassette (600 x 600)		
Model			AM045FNNDH/EU		AM056FNNDH/EU		
Power Supply			Ø, #, V, Hz	1,2,220-240,50			
Mode			-		HP/HR		
Performance	Capacity (Nominal)	Cooling	kW	4.50			
			Btu/h	15,400			
		Heating	kW	5.00			
			Btu/h	17,100			
Power	Power Input (Nominal)	Cooling	W	23.00			
		Heating	W	23.00			
	Current Input (Nominal)	Cooling	A	0.22			
		Heating	A	0.22			
Fan	Motor	Type	-		Turbo Fan		
		Output x n	w	65 x 1		65 x 1	
	Air Flow Rate	H/M/L (UL)	CMM	11.50 / 10.20 / 9.00		13.00 / 11.00 / 9.50	
			l/s	191.67 / 170.00 / 150.00		216.67 / 183.33 / 158.33	
	External Pressure	Min/Std/Max	mmAq	-		-	
Pa			-		-		
Piping Connections	Liquid Pipe	Ø, mm	6.35		6.35		
		Ø, inch	1/4"		1/4"		
	Gas Pipe	Ø, mm	12.70		12.70		
		Ø, inch	1/2"		1/2"		
Drain Pipe	Ø, mm	VP25 (OD 32,ID 25)		VP25 (OD 32,ID 25)			
Field Wiring	Power Source Wire	mm ²	1.5 - 2.5		1.5 - 2.5		
	Transmission Cable	mm ²	0.75 - 1.50		0.75 - 1.50		
Refrigerant	Type	-		R410A			
	Control Method	-		EEV(O)			
Sound	Pressure	High / Mid / Low	dB(A)	36 / 34 / 32		39 / 36 / 33	
	Power	Cooling		53		56	
Dimension	Net Weight		kg	12.00		12.00	
	Shipping Weight		kg	14.00		14.00	
	Net Dimensions (WxHxD)		mm	575 x 250 x 575		575 x 250 x 575	
	Shipping Dimensions (WxHxD)		mm	623 x 298 x 653		623 x 298 x 653	
Panel Size	Panel model		-		PC4SUSMBN		
	Panel Net Weight		kg	2.3		2.3	
	Shipping Weight		kg	3.5		3.5	
	Net Dimensions (WxHxD)		mm	620 x 45 x 620		620 x 45 x 620	
	Shipping Dimensions (WxHxD)		mm	661 x 106 x 671		661 x 106 x 671	
Additional Accessories	Drain Pump	Drain Pump	- / Model	-		-	
		Max. lifting Height / Displacement	mm/liter/h	-		-	
	Air Filter		-		-		

- Mode : HP(Heat Pump), HR(Heat Recovery)

- Nominal Cooling : Indoor temperature 27°CDB / 19°CWB, Outdoor temperature 35°CDB/24°CWB, Refrigerant pipe length 7.5m, Level difference 0m.

- Nominal Heating : Indoor temperature 20°CDB/15°CWB, Outdoor temperature 7°CDB / 6°CWB, Refrigerant pipe length 7.5m, Level difference 0m.

- Sound level was acquired in an anechoic room. Thus actual noise level may be different depending on the installation conditions.

- These products contain R410A which is fluorinated greenhouse gas.

- Specifications may be subject to change without prior notice.

* Heat Exchanger type : Fin & Tube (Fin : Al, Tube : Cu)

1 Specifications

4Way Cassette S (600 x 600)

Type			4Way Cassette (600 x 600)		
Model			AM060FNNDEH/EU		
Power Supply		Ø, #, V, Hz	1,2,220-240,50		
Mode			- / HP/HR		
Performance	Capacity (Nominal)	Cooling	kW	6.00	
			Btu/h	20,500	
		Heating	kW	6.80	
			Btu/h	23,200	
Power	Power Input (Nominal)	Cooling	W	31.00	
		Heating	W	31.00	
	Current Input (Nominal)	Cooling	A	0.30	
		Heating	A	0.30	
Fan	Motor	Type	Turbo Fan		
		Output x n	w / 65 x 1		
	Air Flow Rate	H/M/L (UL)	CMM	13.50 / 12.00 / 10.20	
			l/s	225.00 / 200.00 / 170.00	
	External Pressure	Min/Std/Max	mmAq	-	
Pa			-		
Piping Connections	Liquid Pipe	Ø, mm	6.35		
		Ø, inch	1/4"		
	Gas Pipe	Ø, mm	12.70		
		Ø, inch	1/2"		
	Drain Pipe	Ø, mm	VP25 (OD 32, ID 25)		
Field Wiring	Power Source Wire	mm ²	1.5 - 2.5		
	Transmission Cable	mm ²	0.75 - 1.50		
Refrigerant	Type	-	R410A		
	Control Method	-	EEV(O)		
Sound	Pressure	High / Mid / Low	dB(A)	40 / 38 / 35	
	Power	Cooling		57	
Dimension	Net Weight		kg	12.00	
	Shipping Weight		kg	14.00	
	Net Dimensions (WxHxD)		mm	575 x 250 x 575	
	Shipping Dimensions (WxHxD)		mm	623 x 298 x 653	
Panel Size	Panel model		-	PC4SUSMBN	
	Panel Net Weight		kg	2.3	
	Shipping Weight		kg	3.5	
	Net Dimensions (WxHxD)		mm	620 x 45 x 620	
	Shipping Dimensions (WxHxD)		mm	661 x 106 x 671	
Additional Accessories	Drain Pump	Drain Pump	- / Model	-	
		Max. lifting Height / Displacement	mm/liter/h	-	
	Air Filter		-	-	

- Mode : HP(Heat Pump), HR(Heat Recovery)

- Nominal Cooling : Indoor temperature 27 °CDB / 19 °CWB, Outdoor temperature 35 °CDB/24 °CWB, Refrigerant pipe length 7.5m, Level difference 0m.

- Nominal Heating : Indoor temperature 20 °CDB/15 °CWB, Outdoor temperature 7 °CDB / 6 °CWB, Refrigerant pipe length 7.5m, Level difference 0m.

- Sound level was acquired in an anechoic room. Thus actual noise level may be different depending on the installation conditions.

- These products contain R410A which is fluorinated greenhouse gas.

- Specifications may be subject to change without prior notice.

* Heat Exchanger type : Fin & Tube (Fin : Al, Tube : Cu)

2 Capacity table

4Way Cassette S (600 x 600)

Cooling

TC : Total Capacity, SHC : Sensible Heat Capacity

Capacity Index	Outdoor Air Temp. (°C, DB)	Indoor temperature													
		20(°C, DB)		23(°C, DB)		26(°C, DB)		27(°C, DB)		28(°C, DB)		30(°C, DB)		32(°C, DB)	
		14(°C, WB)		16(°C, WB)		18(°C, WB)		19(°C, WB)		20(°C, WB)		22(°C, WB)		24(°C, WB)	
		TC	SHC	TC	SHC	TC	SHC	TC	SHC	TC	SHC	TC	SHC	TC	SHC
015	10	1.0	0.9	1.2	1.0	1.4	1.1	1.5	1.0	1.6	1.0	1.7	1.0	1.9	1.0
	12	1.0	0.9	1.2	1.0	1.4	1.1	1.5	1.0	1.6	1.0	1.7	1.0	1.8	1.0
	14	1.0	0.9	1.2	1.0	1.4	1.1	1.5	1.0	1.6	1.0	1.7	1.0	1.8	1.0
	16	1.0	0.9	1.2	1.0	1.4	1.1	1.5	1.0	1.6	1.0	1.7	1.0	1.8	1.0
	18	1.0	0.9	1.2	1.0	1.4	1.1	1.5	1.0	1.6	1.0	1.7	1.0	1.8	1.0
	20	1.0	0.9	1.2	1.0	1.4	1.1	1.5	1.0	1.6	1.0	1.7	1.0	1.8	1.0
	21	1.0	0.9	1.2	1.0	1.4	1.1	1.5	1.0	1.6	1.0	1.7	1.0	1.8	1.0
	23	1.0	0.9	1.2	1.0	1.4	1.1	1.5	1.0	1.6	1.0	1.7	1.0	1.8	1.0
	25	1.0	0.9	1.2	1.0	1.4	1.1	1.5	1.0	1.6	1.0	1.7	1.0	1.8	1.0
	27	1.0	0.9	1.2	1.0	1.4	1.1	1.5	1.0	1.6	1.0	1.7	1.0	1.8	1.0
	29	1.0	0.9	1.2	1.0	1.4	1.1	1.5	1.0	1.6	1.0	1.7	1.0	1.8	1.0
	31	1.0	0.9	1.2	1.0	1.4	1.1	1.5	1.0	1.6	1.0	1.7	1.0	1.8	1.0
	33	1.0	0.9	1.2	1.0	1.4	1.1	1.5	1.0	1.6	1.0	1.7	1.0	1.8	1.0
	35	1.0	0.9	1.2	1.0	1.4	1.1	1.5	1.0	1.6	1.0	1.7	1.0	1.8	1.0
	37	1.0	0.9	1.2	1.0	1.4	1.1	1.5	1.0	1.6	1.0	1.7	1.0	1.8	1.0
	39	1.0	0.9	1.2	1.0	1.4	1.1	1.5	1.0	1.6	1.0	1.6	1.0	1.7	1.0
42	1.0	0.9	1.2	1.0	1.4	1.1	1.5	1.0	1.5	1.0	1.6	1.0	1.7	1.0	
44	1.0	0.9	1.2	1.0	1.4	1.1	1.5	1.0	1.5	1.0	1.6	1.0	1.6	1.0	
46	1.0	0.9	1.2	1.0	1.3	1.0	1.4	0.9	1.5	1.0	1.5	0.9	1.6	1.0	
48	1.0	0.9	1.2	1.0	1.3	1.0	1.3	0.9	1.5	1.0	1.4	0.9	1.5	0.9	
022	10	1.5	1.3	1.8	1.4	2.1	1.5	2.2	1.5	2.3	1.5	2.5	1.6	2.6	1.4
	12	1.5	1.3	1.8	1.4	2.1	1.5	2.2	1.5	2.3	1.5	2.5	1.6	2.6	1.4
	14	1.5	1.3	1.8	1.4	2.1	1.5	2.2	1.5	2.3	1.5	2.5	1.6	2.6	1.4
	16	1.5	1.3	1.8	1.4	2.1	1.5	2.2	1.5	2.3	1.5	2.4	1.5	2.6	1.4
	18	1.5	1.3	1.8	1.4	2.1	1.5	2.2	1.5	2.3	1.5	2.4	1.5	2.6	1.4
	20	1.5	1.3	1.8	1.4	2.1	1.5	2.2	1.5	2.3	1.5	2.4	1.5	2.6	1.4
	21	1.5	1.3	1.8	1.4	2.1	1.5	2.2	1.5	2.3	1.5	2.4	1.5	2.6	1.4
	23	1.5	1.3	1.8	1.4	2.1	1.5	2.2	1.5	2.3	1.5	2.4	1.5	2.6	1.4
	25	1.5	1.3	1.8	1.4	2.1	1.5	2.2	1.5	2.3	1.5	2.4	1.5	2.6	1.4
	27	1.5	1.3	1.8	1.4	2.1	1.5	2.2	1.5	2.3	1.5	2.4	1.5	2.6	1.4
	29	1.5	1.3	1.8	1.4	2.1	1.5	2.2	1.5	2.3	1.5	2.4	1.5	2.6	1.4
	31	1.5	1.3	1.8	1.4	2.1	1.5	2.2	1.5	2.3	1.5	2.4	1.5	2.6	1.4
	33	1.5	1.3	1.8	1.4	2.1	1.5	2.2	1.5	2.3	1.5	2.4	1.5	2.6	1.4
	35	1.5	1.3	1.8	1.4	2.1	1.5	2.2	1.5	2.3	1.5	2.4	1.5	2.6	1.4
	37	1.5	1.3	1.8	1.4	2.1	1.5	2.2	1.5	2.3	1.5	2.4	1.5	2.6	1.4
	39	1.5	1.3	1.8	1.4	2.1	1.5	2.2	1.5	2.3	1.5	2.4	1.5	2.5	1.3
42	1.5	1.3	1.8	1.4	2.1	1.5	2.2	1.5	2.3	1.5	2.4	1.5	2.4	1.3	
44	1.5	1.3	1.8	1.4	2.0	1.4	2.1	1.4	2.2	1.4	2.3	1.4	2.4	1.2	
46	1.5	1.3	1.8	1.4	2.0	1.4	2.0	1.4	2.1	1.4	2.2	1.4	2.3	1.2	
48	1.5	1.3	1.8	1.4	2.0	1.4	2.0	1.3	2.1	1.4	2.1	1.3	2.2	1.1	
028	10	1.9	1.6	2.3	1.8	2.6	1.9	2.8	1.9	2.9	1.9	3.1	1.9	3.4	1.9
	12	1.9	1.6	2.3	1.8	2.6	1.9	2.8	1.9	2.9	1.9	3.1	1.9	3.3	1.8
	14	1.9	1.6	2.3	1.8	2.6	1.9	2.8	1.9	2.9	1.9	3.1	1.9	3.3	1.8
	16	1.9	1.6	2.3	1.8	2.6	1.9	2.8	1.9	2.9	1.9	3.1	1.9	3.3	1.8
	18	1.9	1.6	2.3	1.8	2.6	1.9	2.8	1.9	2.9	1.9	3.1	1.9	3.3	1.8
	20	1.9	1.6	2.3	1.8	2.6	1.9	2.8	1.9	2.9	1.9	3.1	1.9	3.3	1.8
	21	1.9	1.6	2.3	1.8	2.6	1.9	2.8	1.9	2.9	1.9	3.1	1.9	3.3	1.8
	23	1.9	1.6	2.3	1.8	2.6	1.9	2.8	1.9	2.9	1.9	3.1	1.9	3.3	1.8
	25	1.9	1.6	2.3	1.8	2.6	1.9	2.8	1.9	2.9	1.9	3.1	1.9	3.3	1.8
	27	1.9	1.6	2.3	1.8	2.6	1.9	2.8	1.9	2.9	1.9	3.1	1.9	3.3	1.8
	29	1.9	1.6	2.3	1.8	2.6	1.9	2.8	1.9	2.9	1.9	3.1	1.9	3.3	1.8
	31	1.9	1.6	2.3	1.8	2.6	1.9	2.8	1.9	2.9	1.9	3.1	1.9	3.3	1.8
	33	1.9	1.6	2.3	1.8	2.6	1.9	2.8	1.9	2.9	1.9	3.1	1.9	3.3	1.8
	35	1.9	1.6	2.3	1.8	2.6	1.9	2.8	1.9	2.9	1.9	3.1	1.9	3.3	1.8
	37	1.9	1.6	2.3	1.8	2.6	1.9	2.8	1.9	2.9	1.9	3.1	1.9	3.3	1.8
	39	1.9	1.6	2.3	1.8	2.6	1.9	2.8	1.9	2.9	1.9	3.0	1.8	3.2	1.7
42	1.9	1.6	2.3	1.8	2.6	1.9	2.8	1.9	2.9	1.9	2.9	1.8	3.1	1.7	
44	1.9	1.6	2.3	1.8	2.5	1.8	2.7	1.8	2.8	1.8	2.8	1.7	3.0	1.6	
46	1.9	1.6	2.3	1.8	2.5	1.8	2.6	1.8	2.7	1.8	2.7	1.6	2.9	1.6	
48	1.9	1.6	2.2	1.8	2.4	1.8	2.5	1.7	2.6	1.7	2.7	1.6	2.8	1.5	

2 Capacity table

4Way Cassette S (600 x 600)

Cooling

TC : Total Capacity, SHC : Sensible Heat Capacity

Capacity Index	Outdoor Air Temp. (°C, DB)	Indoor temperature													
		20(°C, DB)		23(°C, DB)		26(°C, DB)		27(°C, DB)		28(°C, DB)		30(°C, DB)		32(°C, DB)	
		14(°C, WB)		16(°C, WB)		18(°C, WB)		19(°C, WB)		20(°C, WB)		22(°C, WB)		24(°C, WB)	
	TC	SHC	TC	SHC	TC	SHC	TC	SHC	TC	SHC	TC	SHC	TC	SHC	
036	10	2.5	2.2	2.9	2.4	3.4	2.4	3.6	2.6	3.7	2.6	4.0	2.6	4.3	2.5
	12	2.5	2.2	2.9	2.4	3.4	2.4	3.6	2.6	3.7	2.6	4.0	2.6	4.3	2.5
	14	2.5	2.2	2.9	2.4	3.4	2.4	3.6	2.6	3.7	2.6	4.0	2.6	4.3	2.5
	16	2.5	2.2	2.9	2.4	3.4	2.4	3.6	2.6	3.7	2.6	4.0	2.6	4.3	2.5
	18	2.5	2.2	2.9	2.4	3.4	2.4	3.6	2.6	3.7	2.6	4.0	2.6	4.3	2.5
	20	2.5	2.2	2.9	2.4	3.4	2.4	3.6	2.6	3.7	2.6	4.0	2.6	4.2	2.4
	21	2.5	2.2	2.9	2.4	3.4	2.4	3.6	2.6	3.7	2.6	4.0	2.6	4.2	2.4
	23	2.5	2.2	2.9	2.4	3.4	2.4	3.6	2.6	3.7	2.6	4.0	2.6	4.2	2.4
	25	2.5	2.2	2.9	2.4	3.4	2.4	3.6	2.6	3.7	2.6	4.0	2.6	4.2	2.4
	27	2.5	2.2	2.9	2.4	3.4	2.4	3.6	2.6	3.7	2.6	4.0	2.6	4.2	2.4
	29	2.5	2.2	2.9	2.4	3.4	2.4	3.6	2.6	3.7	2.6	4.0	2.6	4.2	2.4
	31	2.5	2.2	2.9	2.4	3.4	2.4	3.6	2.6	3.7	2.6	4.0	2.6	4.2	2.4
	33	2.5	2.2	2.9	2.4	3.4	2.4	3.6	2.6	3.7	2.6	4.0	2.6	4.2	2.4
	35	2.5	2.2	2.9	2.4	3.4	2.4	3.6	2.6	3.7	2.6	4.0	2.6	4.2	2.4
	37	2.5	2.2	2.9	2.4	3.4	2.4	3.6	2.6	3.7	2.6	3.9	2.5	4.2	2.4
	39	2.5	2.2	2.9	2.4	3.4	2.4	3.6	2.6	3.7	2.6	3.9	2.5	4.1	2.3
42	2.5	2.2	2.9	2.4	3.4	2.4	3.6	2.6	3.7	2.6	3.8	2.5	4.0	2.2	
44	2.5	2.2	2.9	2.4	3.3	2.3	3.4	2.5	3.6	2.5	3.7	2.4	3.9	2.2	
46	2.5	2.2	2.9	2.4	3.2	2.3	3.3	2.4	3.4	2.4	3.6	2.3	3.8	2.1	
48	2.5	2.2	2.8	2.3	3.2	2.2	3.2	2.3	3.4	2.4	3.5	2.2	3.6	2.0	
045	10	3.1	2.7	3.7	2.8	4.2	3.0	4.5	3.1	4.7	3.1	5.0	3.1	5.4	2.9
	12	3.1	2.7	3.7	2.8	4.2	3.0	4.5	3.1	4.7	3.1	5.0	3.1	5.4	2.9
	14	3.1	2.7	3.7	2.8	4.2	3.0	4.5	3.1	4.7	3.1	5.0	3.1	5.4	2.9
	16	3.1	2.7	3.7	2.8	4.2	3.0	4.5	3.1	4.7	3.1	5.0	3.1	5.3	2.8
	18	3.1	2.7	3.7	2.8	4.2	3.0	4.5	3.1	4.7	3.1	5.0	3.1	5.3	2.8
	20	3.1	2.7	3.7	2.8	4.2	3.0	4.5	3.1	4.7	3.1	5.0	3.1	5.3	2.8
	21	3.1	2.7	3.7	2.8	4.2	3.0	4.5	3.1	4.7	3.1	5.0	3.1	5.3	2.8
	23	3.1	2.7	3.7	2.8	4.2	3.0	4.5	3.1	4.7	3.1	5.0	3.1	5.3	2.8
	25	3.1	2.7	3.7	2.8	4.2	3.0	4.5	3.1	4.7	3.1	5.0	3.1	5.3	2.8
	27	3.1	2.7	3.7	2.8	4.2	3.0	4.5	3.1	4.7	3.1	5.0	3.1	5.3	2.8
	29	3.1	2.7	3.7	2.8	4.2	3.0	4.5	3.1	4.7	3.1	5.0	3.1	5.3	2.8
	31	3.1	2.7	3.7	2.8	4.2	3.0	4.5	3.1	4.7	3.1	5.0	3.1	5.3	2.8
	33	3.1	2.7	3.7	2.8	4.2	3.0	4.5	3.1	4.7	3.1	5.0	3.1	5.3	2.8
	35	3.1	2.7	3.7	2.8	4.2	3.0	4.5	3.1	4.7	3.1	5.0	3.1	5.3	2.8
	37	3.1	2.7	3.7	2.8	4.2	3.0	4.5	3.1	4.6	3.0	4.9	3.0	5.2	2.7
	39	3.1	2.7	3.7	2.8	4.2	3.0	4.5	3.1	4.6	3.0	4.9	3.0	5.1	2.6
42	3.1	2.7	3.7	2.8	4.2	3.0	4.4	3.1	4.5	3.0	4.8	2.9	5.0	2.5	
44	3.1	2.7	3.7	2.8	4.1	2.9	4.3	3.0	4.4	2.9	4.6	2.8	4.8	2.4	
46	3.1	2.7	3.7	2.8	4.0	2.9	4.2	2.9	4.3	2.8	4.5	2.7	4.7	2.4	
48	3.1	2.7	3.6	2.7	3.9	2.8	4.0	2.8	4.2	2.7	4.3	2.7	4.5	2.3	
056	10	3.9	3.2	4.6	3.5	5.3	3.9	5.6	3.9	5.8	3.9	6.3	3.9	6.7	3.7
	12	3.9	3.2	4.6	3.5	5.3	3.9	5.6	3.9	5.8	3.9	6.3	3.9	6.7	3.7
	14	3.9	3.2	4.6	3.5	5.3	3.9	5.6	3.9	5.8	3.9	6.2	3.8	6.7	3.7
	16	3.9	3.2	4.6	3.5	5.3	3.9	5.6	3.9	5.8	3.9	6.2	3.8	6.6	3.6
	18	3.9	3.2	4.6	3.5	5.3	3.9	5.6	3.9	5.8	3.9	6.2	3.8	6.6	3.6
	20	3.9	3.2	4.6	3.5	5.3	3.9	5.6	3.9	5.8	3.9	6.2	3.8	6.6	3.6
	21	3.9	3.2	4.6	3.5	5.3	3.9	5.6	3.9	5.8	3.9	6.2	3.8	6.6	3.6
	23	3.9	3.2	4.6	3.5	5.3	3.9	5.6	3.9	5.8	3.9	6.2	3.8	6.6	3.6
	25	3.9	3.2	4.6	3.5	5.3	3.9	5.6	3.9	5.8	3.9	6.2	3.8	6.6	3.6
	27	3.9	3.2	4.6	3.5	5.3	3.9	5.6	3.9	5.8	3.9	6.2	3.8	6.6	3.6
	29	3.9	3.2	4.6	3.5	5.3	3.9	5.6	3.9	5.8	3.9	6.2	3.8	6.6	3.6
	31	3.9	3.2	4.6	3.5	5.3	3.9	5.6	3.9	5.8	3.9	6.2	3.8	6.6	3.6
	33	3.9	3.2	4.6	3.5	5.3	3.9	5.6	3.9	5.8	3.9	6.2	3.8	6.6	3.6
	35	3.9	3.2	4.6	3.5	5.3	3.9	5.6	3.9	5.8	3.9	6.2	3.8	6.6	3.6
	37	3.9	3.2	4.6	3.5	5.3	3.9	5.6	3.9	5.8	3.9	6.2	3.8	6.6	3.5
	39	3.9	3.2	4.6	3.5	5.3	3.9	5.6	3.9	5.8	3.9	6.2	3.8	6.6	3.4
42	3.9	3.2	4.6	3.5	5.3	3.9	5.5	3.8	5.7	3.9	6.1	3.7	6.4	3.3	
44	3.9	3.2	4.6	3.5	5.1	3.8	5.3	3.7	5.6	3.7	5.9	3.6	6.2	3.2	
46	3.9	3.2	4.6	3.5	5.0	3.7	5.2	3.6	5.4	3.6	5.7	3.5	6.0	3.1	
48	3.9	3.2	4.5	3.4	5.0	3.6	5.0	3.5	5.3	3.6	5.5	3.4	5.8	3.0	

2 Capacity table

4Way Cassette S (600 x 600)

Cooling

TC : Total Capacity, SHC : Sensible Heat Capacity

Capacity Index	Outdoor Air Temp. (°C, DB)	Indoor temperature													
		20(°C, DB)		23(°C, DB)		26(°C, DB)		27(°C, DB)		28(°C, DB)		30(°C, DB)		32(°C, DB)	
		14(°C, WB)		16(°C, WB)		18(°C, WB)		19(°C, WB)		20(°C, WB)		22(°C, WB)		24(°C, WB)	
		TC	SHC	TC	SHC	TC	SHC	TC	SHC	TC	SHC	TC	SHC	TC	SHC
060	10	4.1	3.5	4.9	4.0	5.6	4.5	6.0	4.5	6.2	4.5	6.7	4.6	7.2	4.4
	12	4.1	3.5	4.9	4.0	5.6	4.5	6.0	4.5	6.2	4.5	6.7	4.6	7.2	4.4
	14	4.1	3.5	4.9	4.0	5.6	4.5	6.0	4.5	6.2	4.5	6.7	4.6	7.1	4.3
	16	4.1	3.5	4.9	4.0	5.6	4.5	6.0	4.5	6.2	4.5	6.7	4.6	7.1	4.3
	18	4.1	3.5	4.9	4.0	5.6	4.5	6.0	4.5	6.2	4.5	6.7	4.6	7.1	4.3
	20	4.1	3.5	4.9	4.0	5.6	4.5	6.0	4.5	6.2	4.5	6.6	4.5	7.1	4.3
	21	4.1	3.5	4.9	4.0	5.6	4.5	6.0	4.5	6.2	4.5	6.6	4.5	7.1	4.3
	23	4.1	3.5	4.9	4.0	5.6	4.5	6.0	4.5	6.2	4.5	6.6	4.5	7.1	4.3
	25	4.1	3.5	4.9	4.0	5.6	4.5	6.0	4.5	6.2	4.5	6.6	4.5	7.1	4.3
	27	4.1	3.5	4.9	4.0	5.6	4.5	6.0	4.5	6.2	4.5	6.6	4.5	7.1	4.3
	29	4.1	3.5	4.9	4.0	5.6	4.5	6.0	4.5	6.2	4.5	6.6	4.5	7.1	4.3
	31	4.1	3.5	4.9	4.0	5.6	4.5	6.0	4.5	6.2	4.5	6.6	4.5	7.1	4.3
	33	4.1	3.5	4.9	4.0	5.6	4.5	6.0	4.5	6.2	4.5	6.6	4.5	7.1	4.3
	35	4.1	3.5	4.9	4.0	5.6	4.5	6.0	4.5	6.2	4.5	6.6	4.5	7.1	4.3
	37	4.1	3.5	4.9	4.0	5.6	4.5	6.0	4.5	6.2	4.5	6.6	4.5	7.0	4.2
	39	4.1	3.5	4.9	4.0	5.6	4.5	6.0	4.5	6.2	4.5	6.5	4.4	6.8	4.1
	42	4.1	3.5	4.9	4.0	5.6	4.5	5.9	4.4	6.1	4.4	6.4	4.3	6.6	4.0
44	4.1	3.5	4.9	4.0	5.4	4.3	5.7	4.3	6.0	4.3	6.1	4.2	6.4	3.9	
46	4.1	3.5	4.9	4.0	5.3	4.3	5.5	4.2	5.8	4.2	5.9	4.0	6.2	3.8	
48	4.0	3.5	4.8	3.9	5.2	4.2	5.4	4.0	5.7	4.1	5.8	3.9	6.0	3.6	

2 Capacity table

4Way Cassette S (600 x 600)

Heating

TC : Total Capacity

Capacity Index	Outdoor Air Temp. (°C)		Indoor temperature (°C,DB)				
			16(°C,DB)	18(°C,DB)	20(°C,DB)	22(°C,DB)	24(°C,DB)
	DB	WB	TC kW	TC kW	TC kW	TC kW	TC kW
015	-19.8	-20.0	1.0	1.0	1.0	1.0	0.9
	-18.8	-19.0	1.0	1.0	1.0	1.0	0.9
	-16.7	-17.0	1.0	1.0	1.0	1.0	0.9
	-14.7	-15.0	1.1	1.1	1.0	1.0	0.9
	-12.6	-13.0	1.1	1.1	1.1	1.1	1.0
	-10.5	-11.0	1.2	1.2	1.2	1.2	1.1
	-9.5	-10.0	1.2	1.2	1.2	1.2	1.1
	-8.5	-9.1	1.3	1.3	1.3	1.3	1.2
	-7.0	-7.6	1.3	1.3	1.3	1.3	1.2
	-5.0	-5.6	1.4	1.4	1.3	1.3	1.2
	-3.0	-3.7	1.4	1.4	1.4	1.3	1.3
	0.0	-0.7	1.5	1.5	1.5	1.4	1.4
	3.0	2.2	1.5	1.5	1.5	1.4	1.4
	5.0	4.1	1.6	1.6	1.6	1.5	1.4
	7.0	6.0	1.7	1.7	1.7	1.6	1.4
9.0	7.9	1.8	1.7	1.7	1.6	1.4	
022	-19.8	-20.0	1.5	1.5	1.5	1.5	1.5
	-18.8	-19.0	1.5	1.5	1.5	1.5	1.5
	-16.7	-17.0	1.6	1.6	1.6	1.6	1.6
	-14.7	-15.0	1.7	1.6	1.6	1.6	1.6
	-12.6	-13.0	1.8	1.8	1.8	1.8	1.7
	-10.5	-11.0	2.0	2.0	1.9	1.9	1.9
	-9.5	-10.0	2.1	2.0	2.0	1.9	1.9
	-8.5	-9.1	2.2	2.1	2.1	2.0	2.0
	-7.0	-7.6	2.3	2.2	2.2	2.0	2.0
	-5.0	-5.6	2.4	2.3	2.3	2.2	2.2
	-3.0	-3.7	2.5	2.5	2.4	2.3	2.2
	0.0	-0.7	2.6	2.5	2.5	2.3	2.2
	3.0	2.2	2.7	2.6	2.5	2.3	2.2
	5.0	4.1	2.8	2.7	2.5	2.3	2.2
	7.0	6.0	2.8	2.7	2.5	2.3	2.2
9.0	7.9	3.0	2.7	2.5	2.3	2.2	
11.0	9.8	3.0	2.7	2.5	2.3	2.2	
13.0	11.8	3.0	2.7	2.5	2.3	2.2	
15.0	13.7	3.0	2.7	2.5	2.3	2.2	
028	-19.8	-20.0	1.9	1.9	1.9	1.9	1.9
	-18.8	-19.0	1.9	1.9	1.9	1.9	1.9
	-16.7	-17.0	2.0	2.0	2.0	2.0	1.9
	-14.7	-15.0	2.1	2.1	2.0	2.0	1.9
	-12.6	-13.0	2.2	2.2	2.2	2.1	2.1
	-10.5	-11.0	2.3	2.3	2.3	2.3	2.2
	-9.5	-10.0	2.3	2.3	2.3	2.3	2.2
	-8.5	-9.1	2.4	2.4	2.4	2.4	2.3
	-7.0	-7.6	2.5	2.4	2.4	2.4	2.3
	-5.0	-5.6	2.6	2.6	2.5	2.5	2.4
	-3.0	-3.7	2.8	2.7	2.7	2.6	2.5
	0.0	-0.7	2.9	2.8	2.8	2.7	2.6
	3.0	2.2	3.0	3.0	2.9	2.8	2.7
	5.0	4.1	3.2	3.1	3.1	2.9	2.7
	7.0	6.0	3.3	3.2	3.2	3.0	2.7
9.0	7.9	3.4	3.3	3.2	3.0	2.7	
11.0	9.8	3.5	3.3	3.2	3.0	2.7	
13.0	11.8	3.6	3.4	3.2	3.0	2.7	
15.0	13.7	3.7	3.4	3.2	3.0	2.7	

2 Capacity table

4Way Cassette S (600 x 600)

Heating

TC : Total Capacity

Capacity Index	Outdoor Air Temp. (°C)		Indoor temperature (°C,DB)				
			16(°C,DB)	18(°C,DB)	20(°C,DB)	22(°C,DB)	24(°C,DB)
	DB	WB	TC kW	TC kW	TC kW	TC kW	TC kW
036	-19.8	-20.0	2.4	2.4	2.3	2.3	2.3
	-18.8	-19.0	2.5	2.4	2.3	2.3	2.3
	-16.7	-17.0	2.6	2.5	2.4	2.4	2.3
	-14.7	-15.0	2.7	2.6	2.5	2.5	2.4
	-12.6	-13.0	2.8	2.7	2.7	2.6	2.6
	-10.5	-11.0	2.9	2.9	2.9	2.8	2.8
	-9.5	-10.0	2.9	2.9	2.9	2.8	2.8
	-8.5	-9.1	3.0	3.0	3.0	2.9	2.9
	-7.0	-7.6	3.1	3.1	3.0	3.0	2.9
	-5.0	-5.6	3.3	3.2	3.2	3.1	3.0
	-3.0	-3.7	3.4	3.4	3.3	3.2	3.1
	0.0	-0.7	3.6	3.6	3.5	3.4	3.2
	3.0	2.2	3.8	3.7	3.7	3.5	3.4
	5.0	4.1	3.9	3.9	3.8	3.6	3.4
	7.0	6.0	4.1	4.1	4.0	3.7	3.4
9.0	7.9	4.2	4.1	4.0	3.7	3.4	
11.0	9.8	4.4	4.2	4.0	3.7	3.4	
13.0	11.8	4.5	4.2	4.0	3.7	3.4	
15.0	13.7	4.6	4.3	4.0	3.7	3.4	
045	-19.8	-20.0	3.1	3.1	2.9	2.9	2.9
	-18.8	-19.0	3.1	3.1	3.0	2.9	2.9
	-16.7	-17.0	3.2	3.2	3.1	3.0	3.0
	-14.7	-15.0	3.3	3.3	3.2	3.1	3.0
	-12.6	-13.0	3.5	3.4	3.4	3.3	3.2
	-10.5	-11.0	3.7	3.6	3.6	3.5	3.4
	-9.5	-10.0	3.7	3.6	3.6	3.5	3.5
	-8.5	-9.1	3.8	3.7	3.7	3.6	3.6
	-7.0	-7.6	3.9	3.8	3.8	3.7	3.6
	-5.0	-5.6	4.1	4.0	4.0	3.9	3.7
	-3.0	-3.7	4.3	4.2	4.2	4.0	3.9
	0.0	-0.7	4.5	4.4	4.4	4.2	4.0
	3.0	2.2	4.7	4.7	4.6	4.4	4.2
	5.0	4.1	4.9	4.9	4.8	4.5	4.2
	7.0	6.0	5.1	5.1	5.0	4.6	4.2
9.0	7.9	5.3	5.2	5.0	4.6	4.2	
11.0	9.8	5.5	5.2	5.0	4.6	4.2	
13.0	11.8	5.6	5.3	5.0	4.6	4.2	
15.0	13.7	5.8	5.4	5.0	4.6	4.2	
056	-19.8	-20.0	3.9	3.8	3.8	3.7	3.7
	-18.8	-19.0	3.9	3.9	3.8	3.7	3.7
	-16.7	-17.0	4.0	4.0	3.9	3.8	3.8
	-14.7	-15.0	4.2	4.1	4.0	3.9	3.8
	-12.6	-13.0	4.4	4.3	4.2	4.1	4.0
	-10.5	-11.0	4.6	4.5	4.4	4.4	4.3
	-9.5	-10.0	4.7	4.6	4.6	4.5	4.4
	-8.5	-9.1	4.8	4.7	4.7	4.6	4.5
	-7.0	-7.6	4.9	4.8	4.8	4.7	4.5
	-5.0	-5.6	5.2	5.1	5.0	4.9	4.7
	-3.0	-3.7	5.4	5.3	5.3	5.1	4.9
	0.0	-0.7	5.7	5.6	5.5	5.3	5.0
	3.0	2.2	5.9	5.9	5.8	5.6	5.3
	5.0	4.1	6.2	6.1	6.0	5.7	5.3
	7.0	6.0	6.5	6.4	6.3	5.8	5.3
9.0	7.9	6.7	6.5	6.3	5.8	5.3	
11.0	9.8	6.9	6.6	6.3	5.8	5.3	
13.0	11.8	7.1	6.7	6.3	5.8	5.3	
15.0	13.7	7.3	6.8	6.3	5.8	5.3	

2 Capacity table

4Way Cassette S (600 x 600)

Heating

TC : Total Capacity

Capacity Index	Outdoor Air Temp. (°C)		Indoor temperature (°C,DB)				
			16(°C,DB)	18(°C,DB)	20(°C,DB)	22(°C,DB)	24(°C,DB)
	DB	WB	TC	TC	TC	TC	TC
060	-19.8	-20.0	4.4	4.3	4.2	4.2	4.2
	-18.8	-19.0	4.4	4.3	4.2	4.2	4.2
	-16.7	-17.0	4.5	4.4	4.3	4.3	4.2
	-14.7	-15.0	4.7	4.6	4.4	4.3	4.2
	-12.6	-13.0	4.9	4.8	4.6	4.5	4.4
	-10.5	-11.0	5.1	5.0	4.9	4.8	4.8
	-9.5	-10.0	5.2	5.2	5.1	5.0	4.9
	-8.5	-9.1	5.3	5.3	5.2	5.1	5.0
	-7.0	-7.6	5.4	5.4	5.3	5.2	5.1
	-5.0	-5.6	5.7	5.6	5.6	5.4	5.2
	-3.0	-3.7	6.0	5.9	5.9	5.6	5.4
	0.0	-0.7	6.3	6.2	6.1	5.9	5.6
	3.0	2.2	6.6	6.5	6.4	6.2	5.9
	5.0	4.1	6.9	6.8	6.7	6.3	5.9
	7.0	6.0	7.2	7.1	6.8	6.5	5.9
	9.0	7.9	7.4	7.2	6.8	6.5	5.9
11.0	9.8	7.6	7.3	6.8	6.5	5.9	
13.0	11.8	7.9	7.4	6.8	6.5	5.9	
15.0	13.7	8.1	7.5	6.8	6.5	5.9	

3 Dimensional drawing

4Way Cassette S (600 x 600)

AM015HNNDEH/EU, AM022FNNDEH/EU, AM028FNNDEH/EU, AM036FNNDEH/EU, AM045FNNDEH/EU, AM056FNNDEH/EU, AM060FNNDEH/EU

Units : mm [inches]

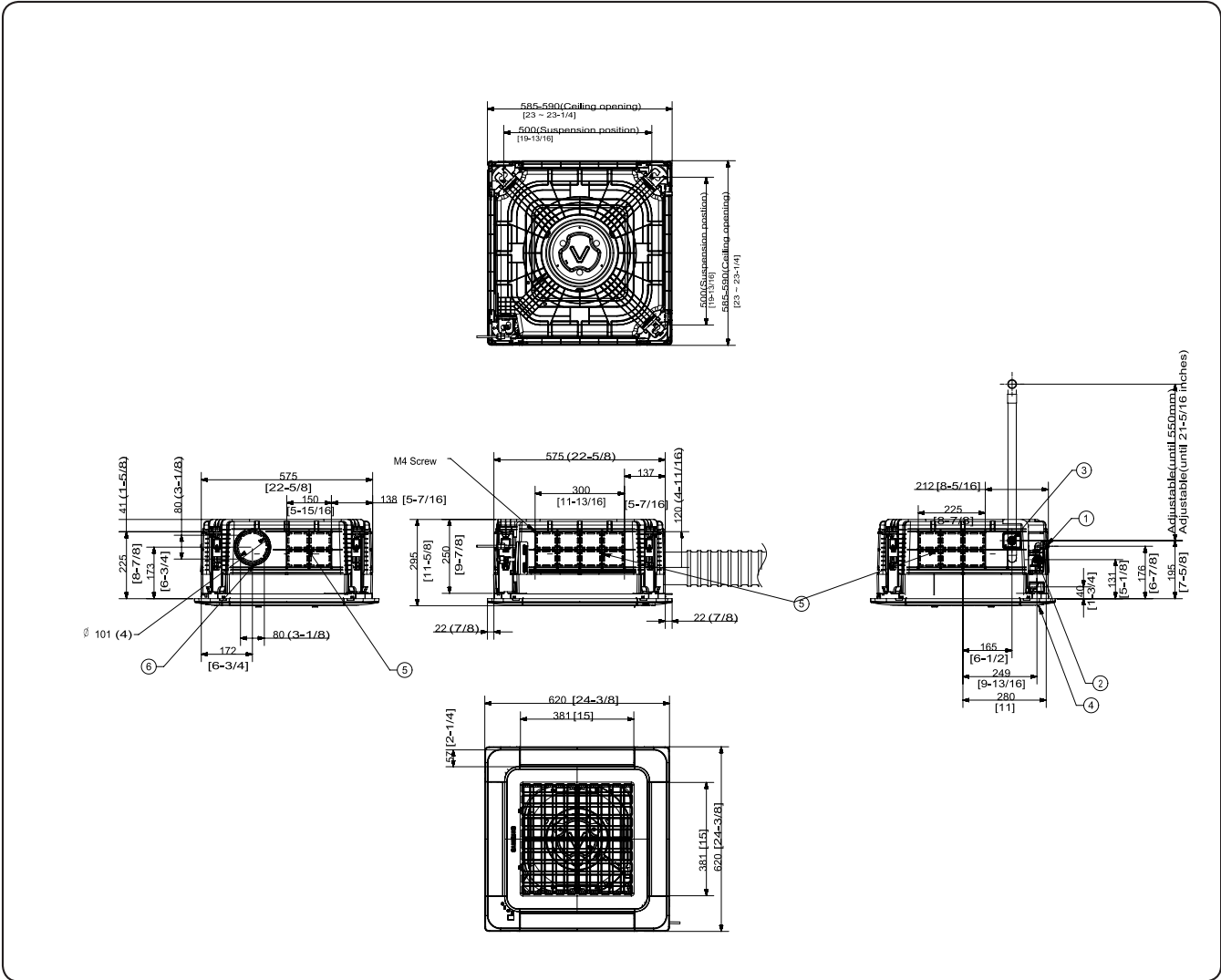

No.	Name	Description
①	Liquid pipe connection	Ø6.35mm (1/4") Flare
②	Gas pipe connection	Ø12.7mm (1/2") Flare
③	Drain pipe connection	VP25 (OD32, ID25)
④	Conduit for power supply & communication wiring	-
⑤	Sub duct connection	Use M4 Screw
⑥	Fresh air intake knockout hole	Φ101[4] , Use M4 Screw

4 Electrical wiring diagram

4Way Cassette S(600x600)

AM015HNNDEH/EU, AM022FNNDEH/EU, AM028FNNDEH/EU, AM036FNNDEH/EU, AM045FNNDEH/EU, AM056FNNDEH/EU, AM060FNNDEH/EU

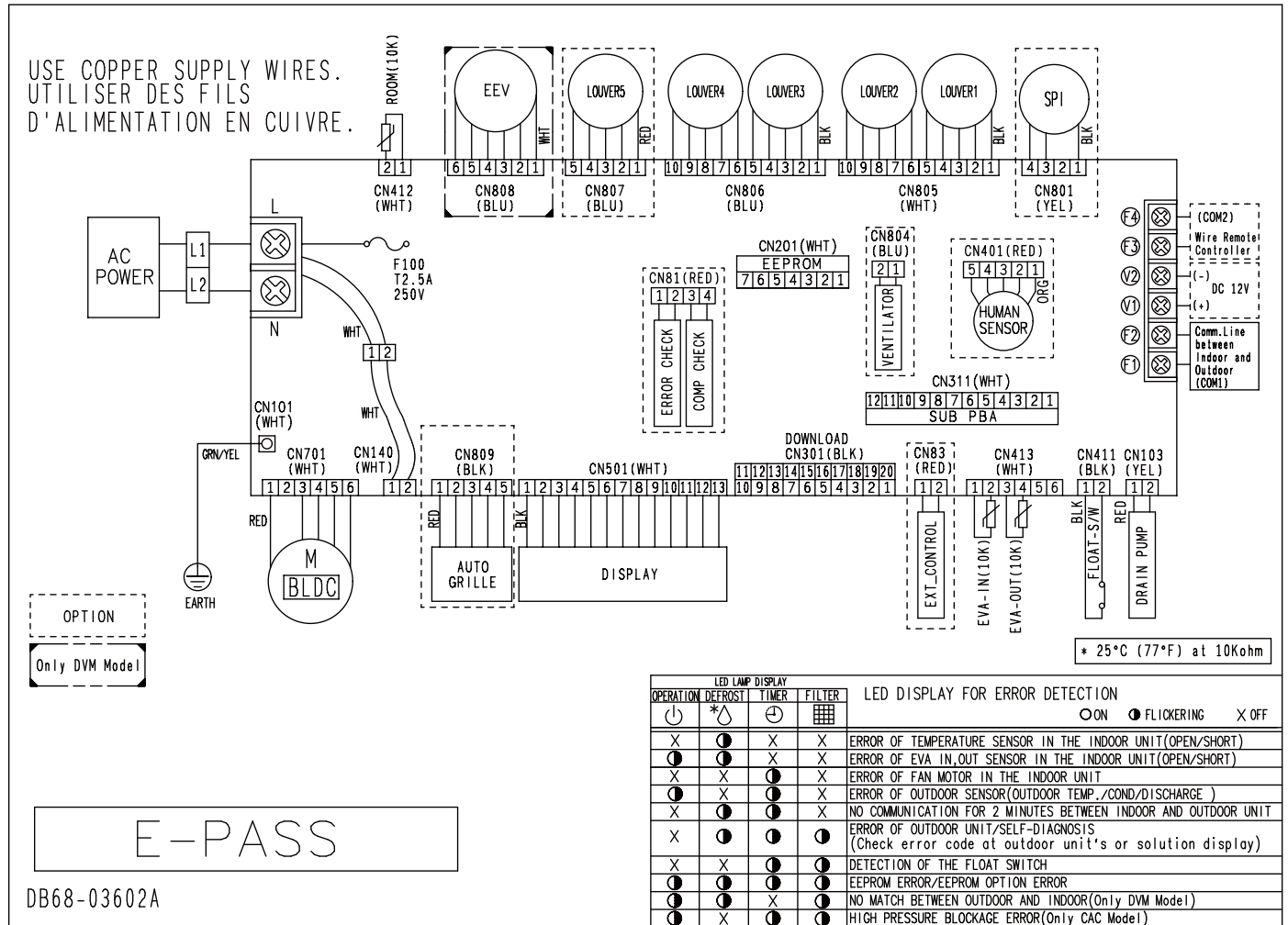

NOTE

1. This wiring diagram applies only to the indoor unit.
2. Symbols show as follow;
BLK : black, RED : red, BLU : blue, WHT:white, YEL : yellow, BRN : brown, SKY : sky-blue, GRN : green
3. For connection wiring indoor-outdoor transmission F1-F2, indoor-wired remotecontroller transmission F3-F4.
4. : Protective earth(screw), : Connector, n : The wire quantity

5 Sound pressure level

4Way Cassette S (600 x 600)

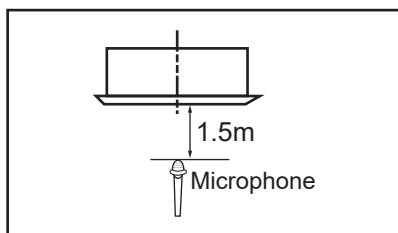

Unit: dB(A)

Model	High	Low
AM015HNNDEH/EU	30	23
AM022FNNDEH/EU	32	25
AM028FNNDEH/EU	33	26
AM036FNNDEH/EU	34	26

Note

Specifications may be subject to change without prior notice.
 Sound pressure level is obtained in an anechoic room.
 Sound pressure level is a relative value, depending on the distance and acoustic environment.
 Sound pressure level may differ depending on operation condition.
 dBA = A-weighted sound pressure level
 Reference acoustic pressure 0 dB= 20 uPa

NR curve

1) AM015HNNDEH/EU

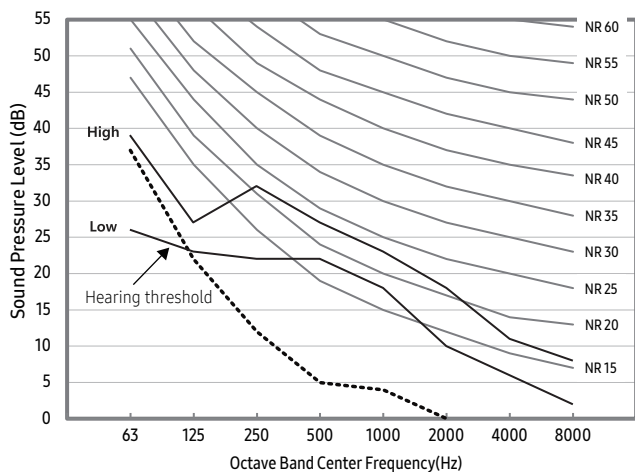

2) AM022FNNDEH/EU

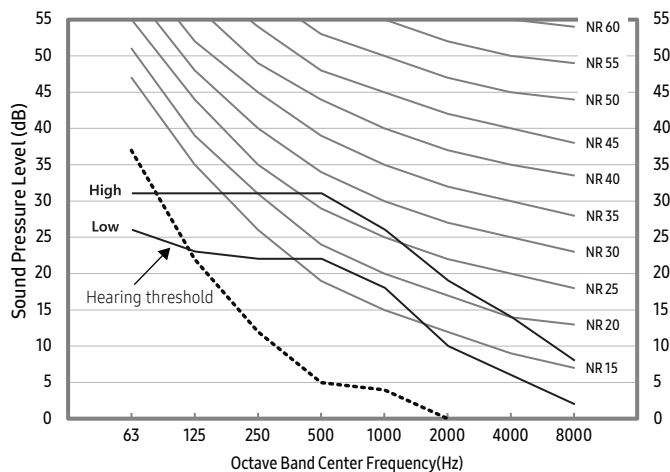

3) AM028FNNDEH/EU

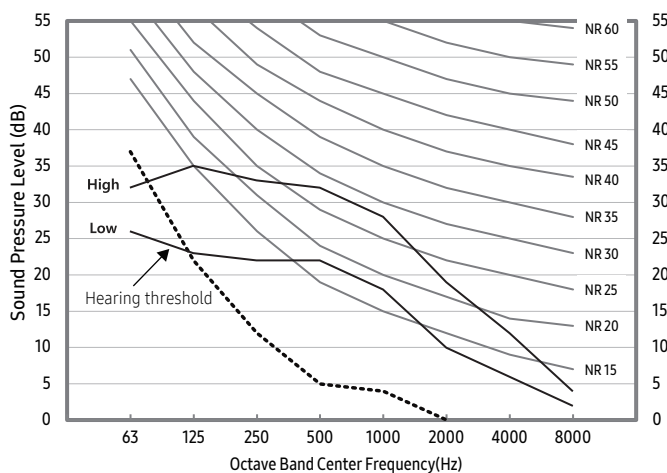

4) AM036FNNDEH/EU

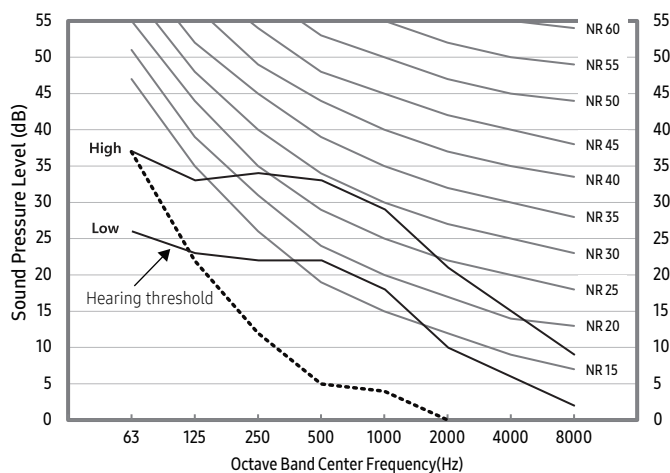

5 Sound pressure level

4Way Cassette S (600 x 600)

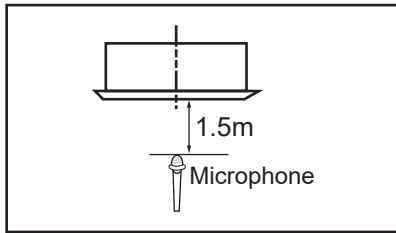

Unit: dB(A)

Model	High	Low
AM045FNNDEH/EU	36	32
AM056FNNDEH/EU	39	33
AM060FNNDEH/EU	40	35

Note

Specifications may be subject to change without prior notice.
 Sound pressure level is obtained in an anechoic room.
 Sound pressure level is a relative value, depending on the distance and acoustic environment.
 Sound pressure level may differ depending on operation condition.
 dBA = A-weighted sound pressure level
 Reference acoustic pressure 0 dB= 20 uPa

NR curve

1) AM045FNNDEH/EU

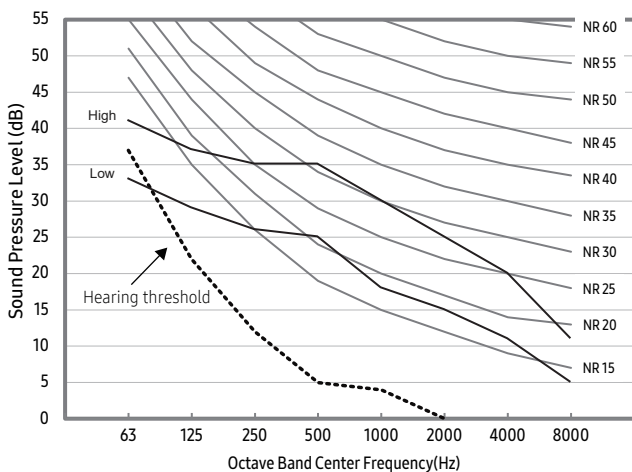

2) AM056FNNDEH/EU

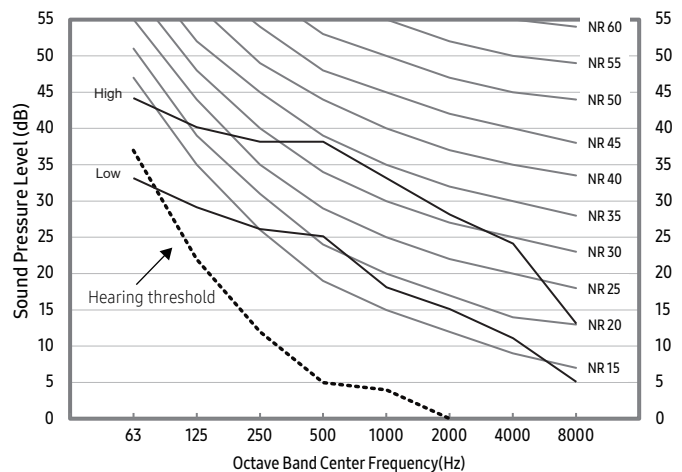

3) AM060FNNDEH/EU

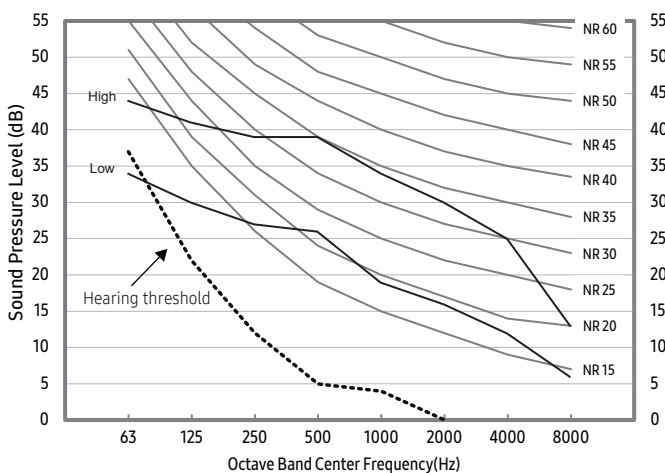

6 Sound power level

4Way Cassette S (600 x 600)

Note

- . Specifications may be subject to change without prior notice.
- . Sound power level is an absolute value that a sound source generates.
- . dBA = A-weighted sound power level.
- . Reference power : 1pW.
- . Measured according to ISO 3741

Unit: dB(A)

Model	Power
AM015HNNDEH/EU	46
AM022FNNDEH/EU	47
AM028FNNDEH/EU	50
AM036FNNDEH/EU	51

1)AM015HNNDEH/EU

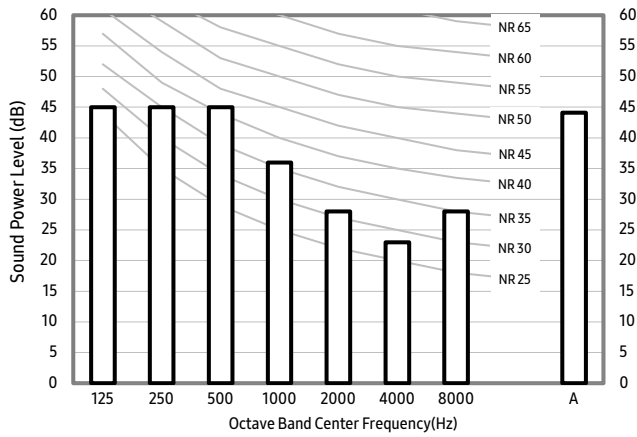

2)AM022FNNDEH/EU

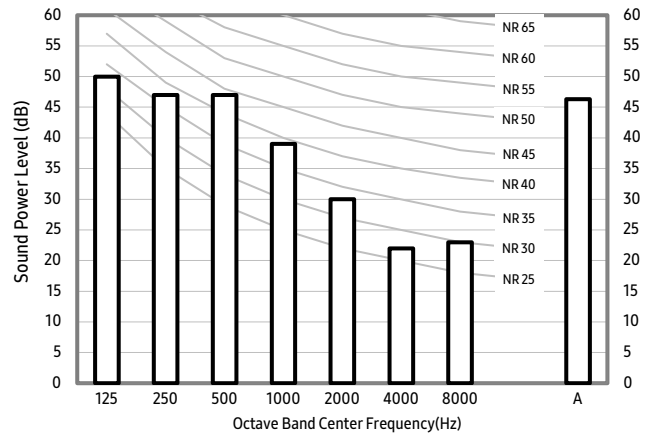

3)AM028FNNDEH/EU

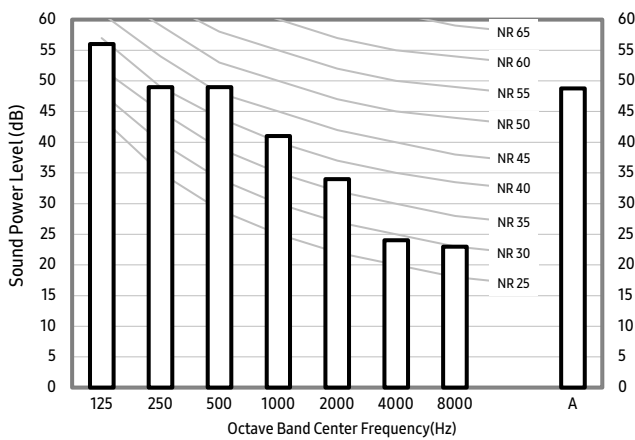

4)AM036FNNDEH/EU

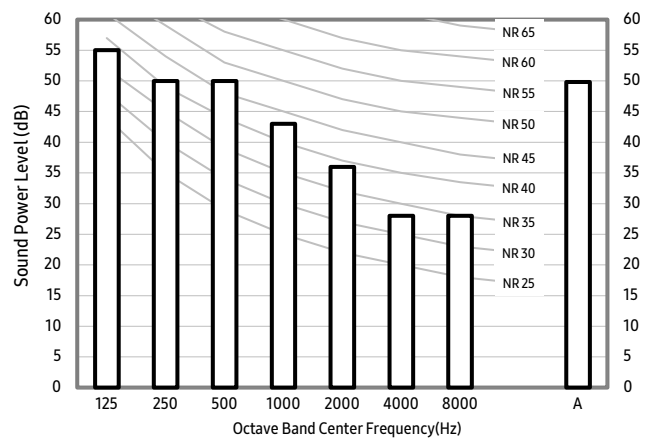

6 Sound power level

4Way Cassette S (600 x 600)

Note

- . Specifications may be subject to change without prior notice.
- . Sound power level is an absolute value that a sound source generates.
- . dBA = A-weighted sound power level.
- . Reference power : 1pW.
- . Measured according to ISO 3741

Unit: dB(A)

Model	Power
AM045FNNDEH/EU	53
AM056FNNDEH/EU	56
AM060FNNDEH/EU	57

1)AM045FNNDEH/EU

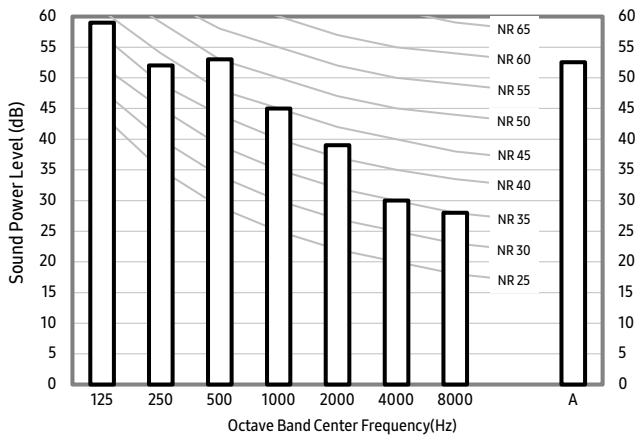

2)AM056FNNDEH/EU

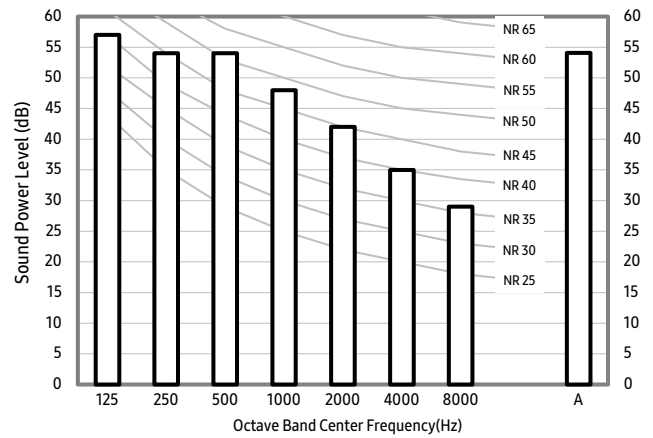

3)AM060FNNDEH/EU

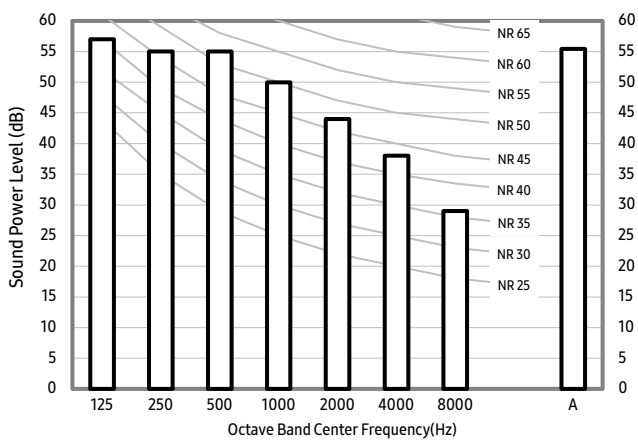

7 Temperature and air flow distribution

4Way Cassette S(600x600)

AM015HNNDEHEU

(1) Cooling air velocity distribution

Discharge angle : 41°

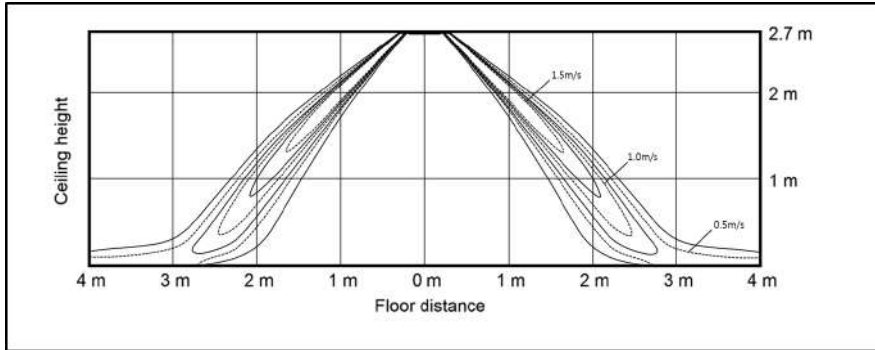

(2) Cooling temperature distribution

Discharge angle : 41°

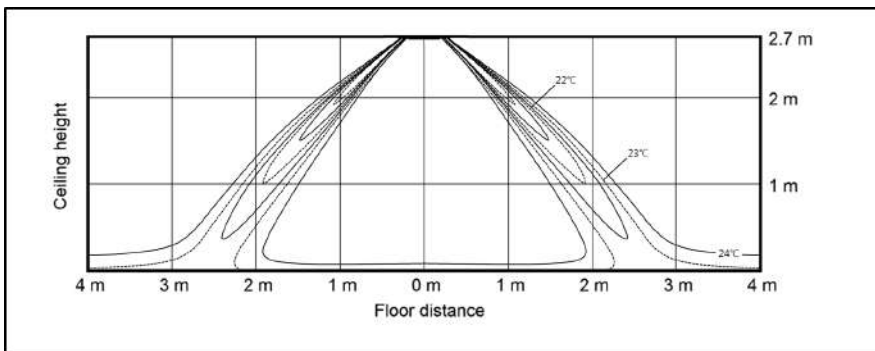

(3) Heating air velocity distribution

Discharge angle : 43°

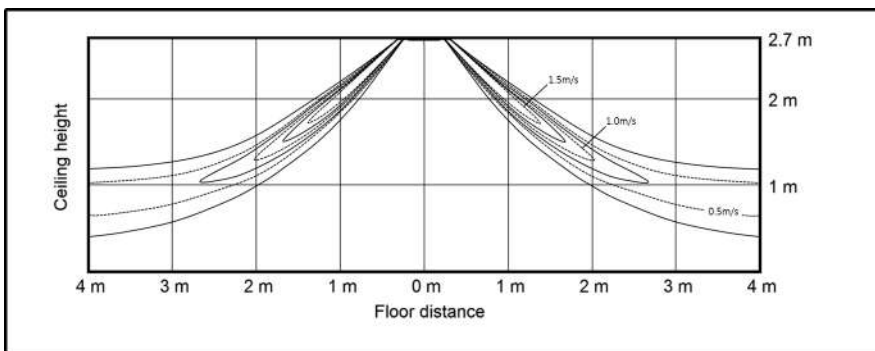

(4) Heating temperature distribution

Discharge angle : 43°

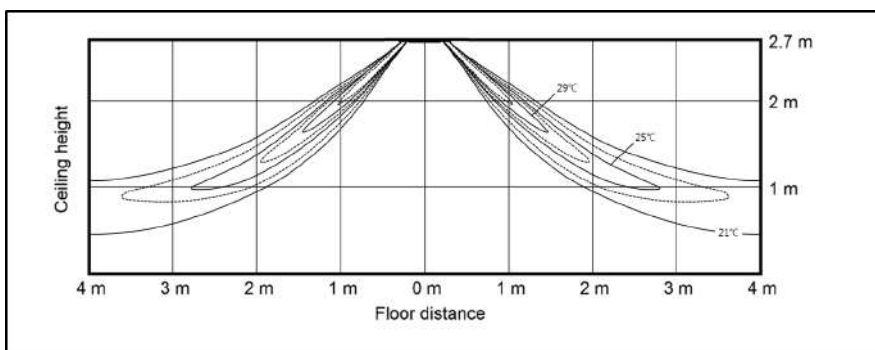

7 Temperature and air flow distribution

4Way Cassette S(600x600)

AM022FNNDEH/EU

(1) Cooling air velocity distribution

Discharge angle : 41°

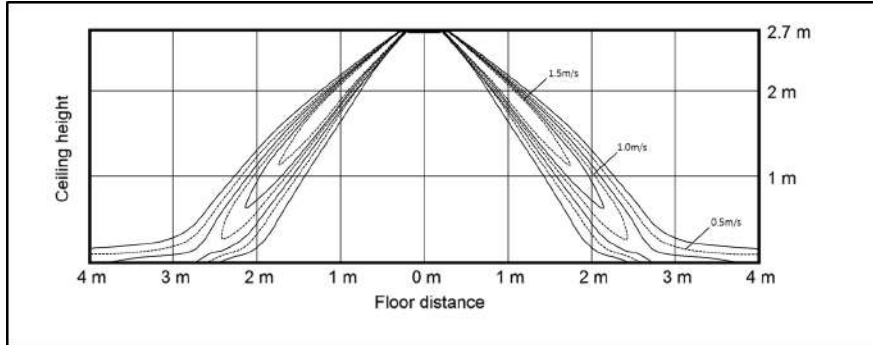

(2) Cooling temperature distribution

Discharge angle : 41°

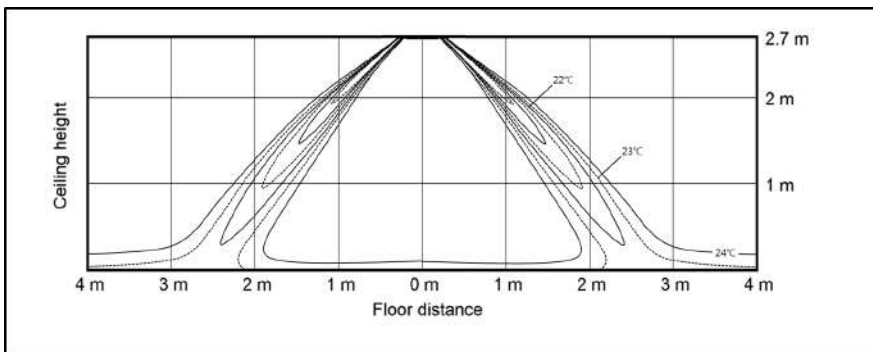

(3) Heating air velocity distribution

Discharge angle : 43°

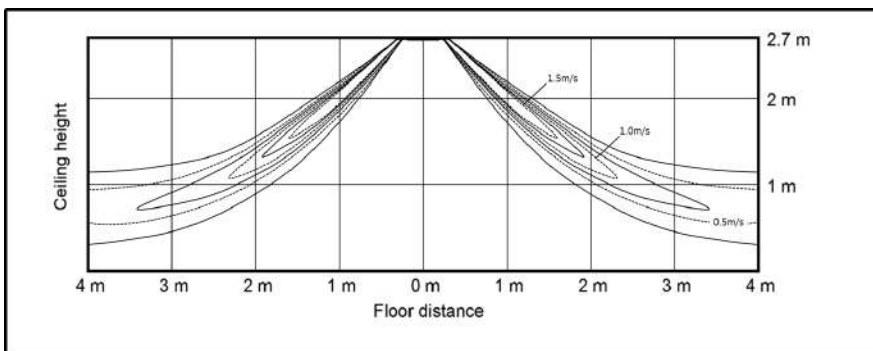

(4) Heating temperature distribution

Discharge angle : 43°

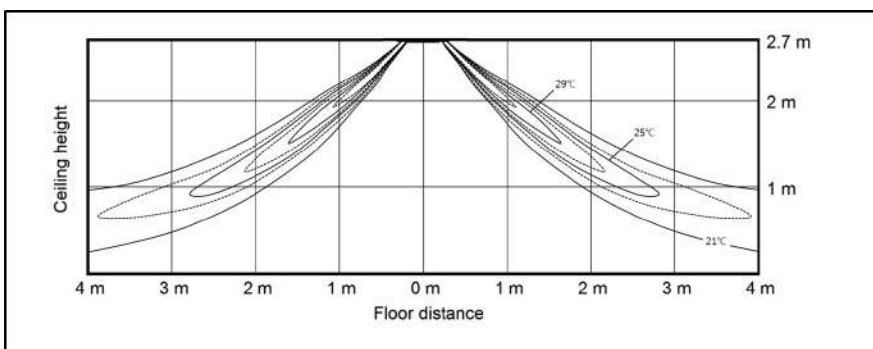

7 Temperature and air flow distribution

4Way Cassette S(600x600)

AM028FNNDEH/EU

(1) Cooling air velocity distribution

Discharge angle : 41°

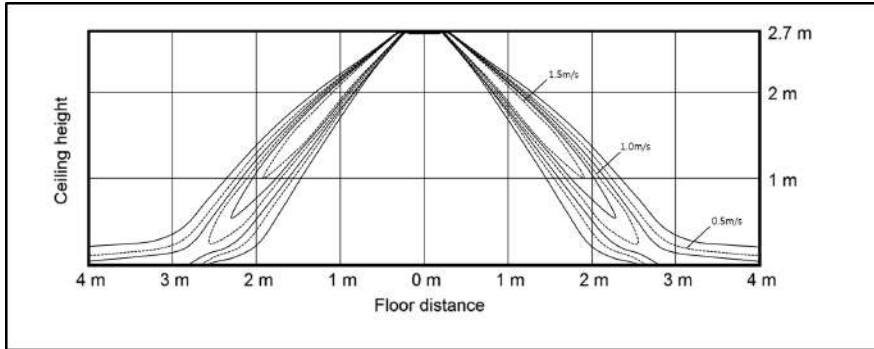

(2) Cooling temperature distribution

Discharge angle : 41°

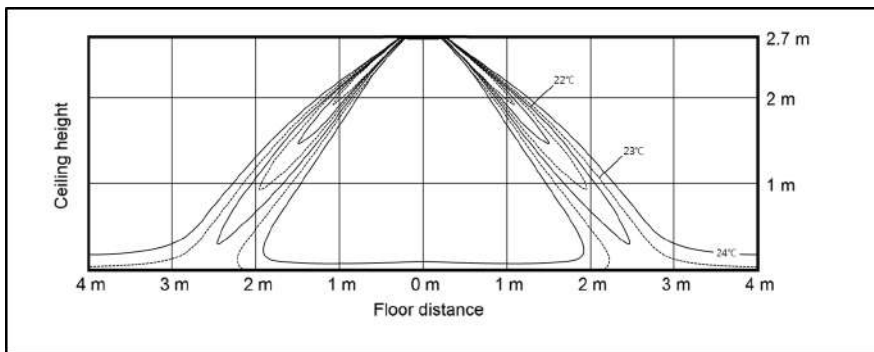

(3) Heating air velocity distribution

Discharge angle : 43°

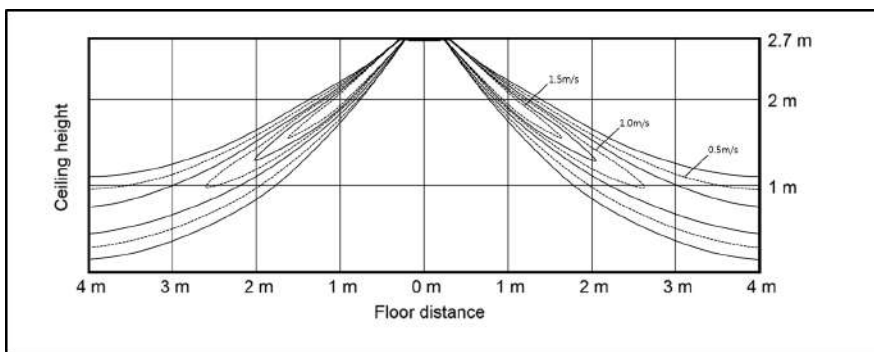

(4) Heating temperature distribution

Discharge angle : 43°

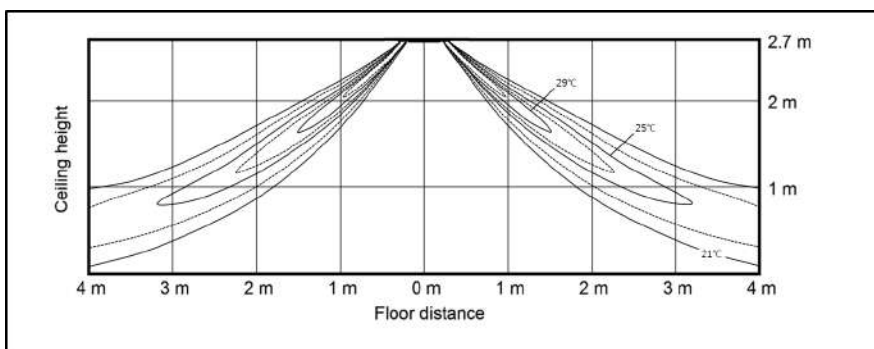

7 Temperature and air flow distribution

4Way Cassette S(600x600)

AM036FNNDEH/EU

(1) Cooling air velocity distribution

Discharge angle : 37°

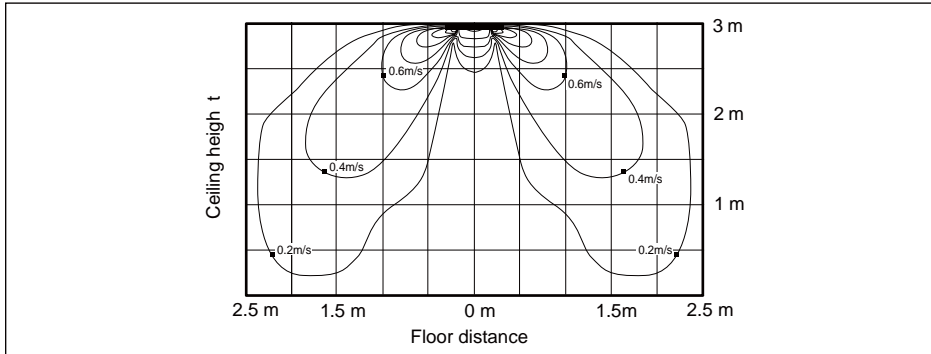

(2) Cooling temperature distribution

Discharge angle : 37°

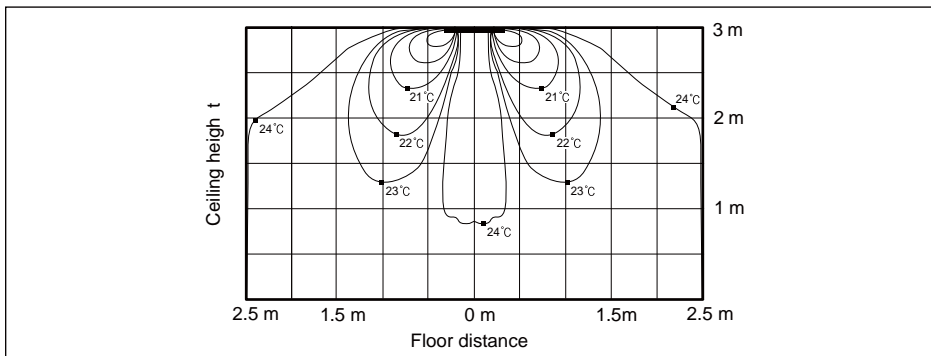

(3) Heating air velocity distribution

Discharge angle : 49°

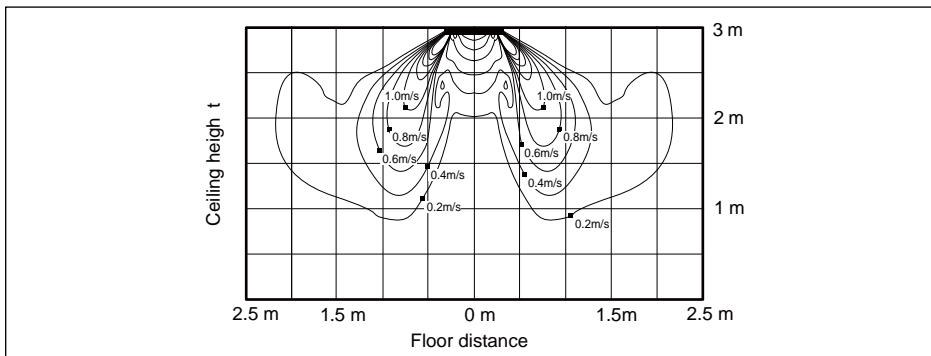

(4) Heating temperature distribution

Discharge angle : 49°

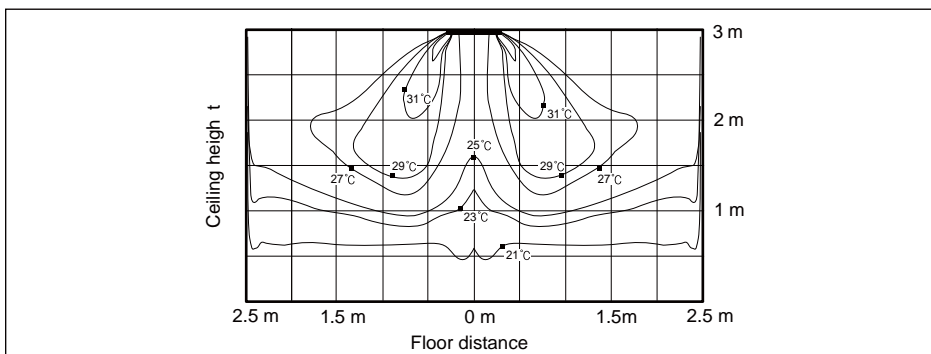

7 Temperature and air flow distribution

4Way Cassette S(600x600)

AM060FNNDEH/EU

(1) Cooling air velocity distribution

Discharge angle : 37°

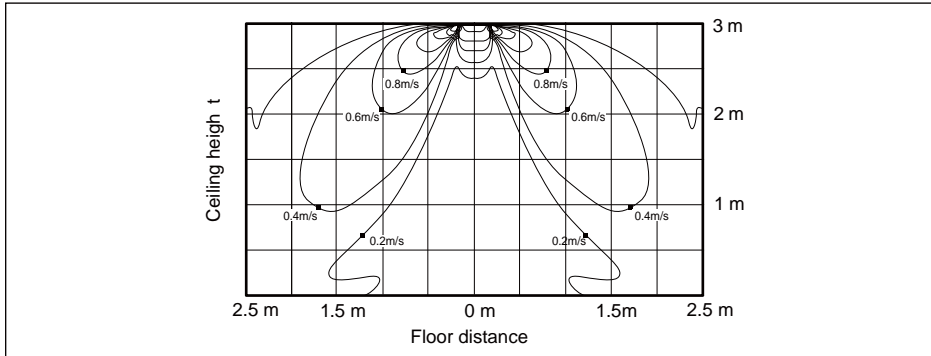

(2) Cooling temperature distribution

Discharge angle : 37°

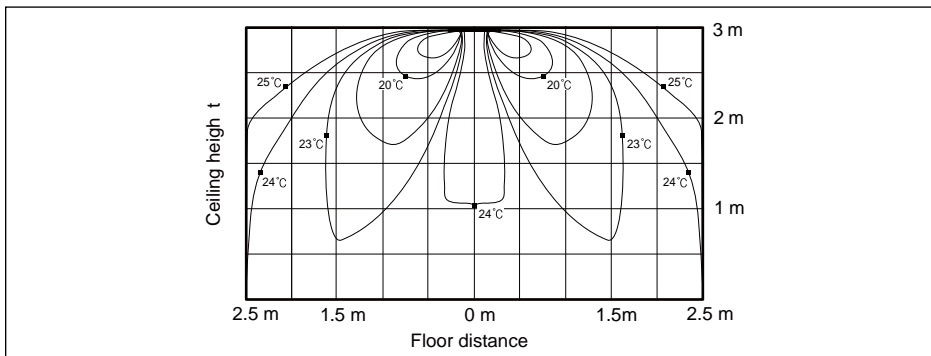

(3) Heating air velocity distribution

Discharge angle : 49°

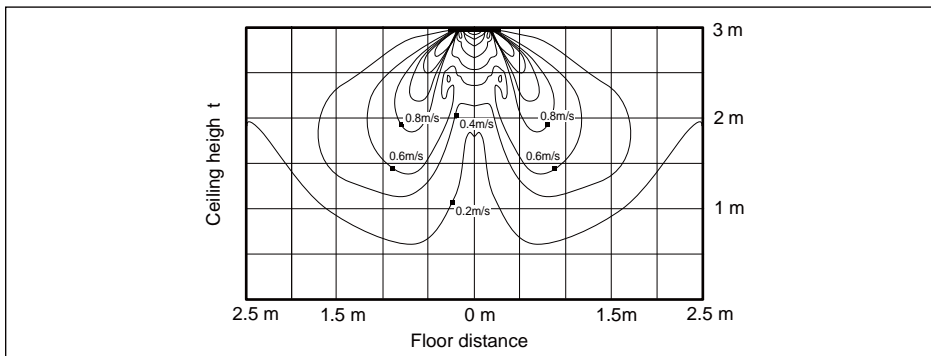

(4) Heating temperature distribution

Discharge angle : 49°

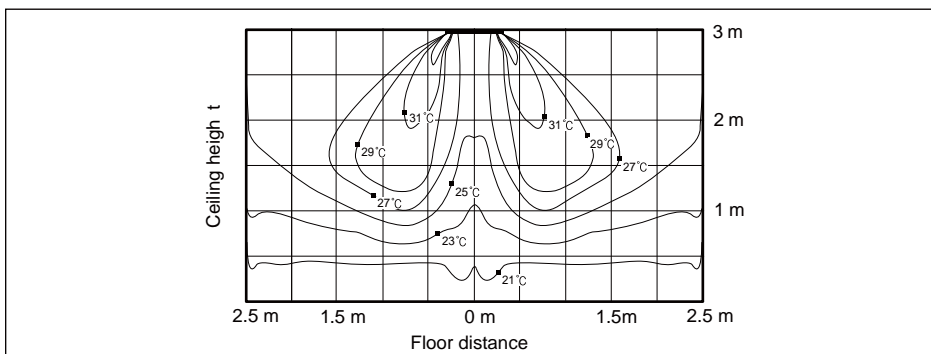

4Way Cassette

- 1 *Specifications*
- 2 *Summary Table*
- 3 *Capacity Table*
- 4 *Dimensional Drawing*
- 5 *Center of Gravity*
- 6 *Electrical Wiring Diagram*
- 7 *Sound data*
- 8 *Temperature and Air Flow Distribution*
- 9 *Piping Diagram*

1. Specification

4Way Cassette

Type				4Way Cassette	4Way Cassette	4Way Cassette	4Way Cassette
Model Name				AM045FN4DEH***	AM056FN4DEH***	AM071FN4DEH***	AM090FN4DEH***
Power Supply			Φ, #, V, Hz	1,2,220~240,50	1,2,220~240,50	1,2,220~240,50	1,2,220~240,50
Mode				-	HP/HR	HP/HR	HP/HR
Performance	Capacity (Nominal)	Cooling	kW	4.5	5.6	7.1	9.0
			Btu/h	15,400	19,100	24,200	30,700
		Heating	kW	5.0	6.3	8.0	10.0
			Btu/h	17,100	21,500	27,300	34,100
Power	Power Input (Nominal)	Cooling	kW	32	32	45	62
		Heating		32	32	45	62
	Current Input (Nominal)	Cooling	A	0.22	0.22	0.31	0.43
		Heating		0.22	0.22	0.31	0.43
	Current	MCA	A	0.3	0.3	0.4	0.6
		MFA/MOP		15	15	15	15
Heat exchanger	Type		-	Fin & Tube	Fin & Tube	Fin & Tube	Fin & Tube
	Material	Fin	-	Al	Al	Al	Al
		Tube	-	Cu	Cu	Cu	Cu
	Fin Treatment		-	Anti-corrosion	Anti-corrosion	Anti-corrosion	Anti-corrosion
Fan	Type		-	Turbo Fan	Turbo Fan	Turbo Fan	Turbo Fan
	Quantity		ea	1	1	1	1
	Air Flow Rate	H/M/L (UL)	m ³ /min	14.5 / 13.5 / 12.5	15.0 / 14.0 / 13.0	17.0 / 15.5 / 14.5	19.5 / 18.0 / 16.5
			l/s	242 / 225 / 208	250 / 233 / 217	283 / 258 / 242	325 / 300 / 275
Fan Motor	Model		-	BLDC Motor	BLDC Motor	BLDC Motor	BLDC Motor
	Output x n		W	65 x 1	65 x 1	65 x 1	65 x 1
Piping Connections	Liquid Pipe		Type	Flare connection	Flare connection	Flare connection	Flare connection
			Φ, mm	6.35	6.35	9.52	9.52
			Φ, inch	1/4"	1/4"	3/8"	3/8"
	Gas Pipe		Type	Flare connection	Flare connection	Flare connection	Flare connection
			Φ, mm	12.7	12.7	15.88	15.88
			Φ, inch	1/2"	1/2"	5/8"	5/8"
	Drain Pipe		Φ, mm	VP25 (OD 32,ID 25)	VP25 (OD 32,ID 25)	VP25 (OD 32,ID 25)	VP25 (OD 32,ID 25)
Wiring connections	For power supply	Minimum	mm ²	1.5	1.5	1.5	1.5
	For connection with indoor	Minimum	mm ²	0.75	0.75	0.75	0.75
		Remark	-	F1,F2	F1,F2	F1,F2	F1,F2
Refrigerant	Type		-	R410A	R410A	R410A	R410A
	Control Method		-	EEV Included	EEV Included	EEV Included	EEV Included
Sound	Sound Pressure	High / Mid / Low	dB(A)	33 / 32 / 30	33 / 32 / 30	35 / 34 / 33	39 / 36 / 33
	Sound Power	Cooling (Nominal)		49	50	54	57
Dimension	Net Weight		kg	15.5	15.5	15.5	15.5
	Shipping Weight		kg	19.5	19.5	19.5	19.5
	Net Dimensions (WxHxD)		mm	840 x 204 x 840	840 x 204 x 840	840 x 204 x 840	840 x 204 x 840
	Shipping Dimensions (WxHxD)		mm	898 x 275 x 898	898 x 275 x 898	898 x 275 x 898	898 x 275 x 898

1. Specification

Type			4Way Cassette	4Way Cassette	4Way Cassette	4Way Cassette
Model Name			AM045FN4DEH***	AM056FN4DEH***	AM071FN4DEH***	AM090FN4DEH***
Air filter	Type	-	Washable	Washable	Washable	Washable
Panel Size	Panel model	-	PC4NUSKAN	PC4NUSKAN	PC4NUSKAN	PC4NUSKAN
	Panel Net Weight	kg	5.80	5.80	5.80	5.80
	Shipping Weight	kg	8.4	8.4	8.4	8.4
	Net Dimensions (W×H×D)	mm	950 x 45 x 950	950 x 45 x 950	950 x 45 x 950	950 x 45 x 950
	Shipping Dimensions (W×H×D)	mm	1,005 x 100 x 1,005	1,005 x 100 x 1,005	1,005 x 100 x 1,005	1,005 x 100 x 1,005
Drain pump		-	Included	Included	Included	Included
	Max. lifting Height	mm	750	750	750	750

NOTE

- Mode : HP(Heat Pump), HR(Heat Recovery)
 - Nominal Cooling : Indoor temperature 27°C DB / 19°C WB, Outdoor temperature 35°C DB/24°C WB, Refrigerant pipe length 7.5m, Level difference 0m.
 - Nominal Heating : Indoor temperature 20°C DB / 15°C WB, Outdoor temperature 7°C DB / 6°C WB, Refrigerant pipe length 7.5m, Level difference 0m.
 - Sound level was acquired in an anechoic room. Thus actual noise level may be different depending on the installation conditions.
 - These products contain R410A which is fluorinated greenhouse gas.
 - Specifications may be subject to change without prior notice.
 - Select wire size based on the value of MCA
 - Drain pump included (check valve included)
-

1. Specification

Type				4Way Cassette	4Way Cassette	4Way Cassette
Model Name				AM112FN4DEHXXX	AM128FN4DEHXXX	AM140FN4DEHXXX
Power Supply			Φ, #, V, Hz	1,2,220-240,50	1,2,220-240,50	1,2,220-240,50
Mode				-	HP/HR	HP/HR
Performance	Capacity (Nominal)	Cooling	kW	11.2	12.8	14.0
			Btu/h	38,200	43,700	47,800
		Heating	kW	12.5	13.8	16.0
			Btu/h	42,700	47,100	54,600
Power	Power Input (Nominal)	Cooling	kW	78	73	89
		Heating		78	73	89
	Current Input (Nominal)	Cooling	A	0.55	0.51	0.62
		Heating		0.55	0.51	0.62
	Current	MCA	A	0.9	0.8	0.9
		MFA/MOP		15	15	15
Heat exchanger	Type		-	Fin & Tube	Fin & Tube	Fin & Tube
	Material	Fin	-	Al	Al	Al
		Tube	-	Cu	Cu	Cu
	Fin Treatment		-	Anti-corrosion	Anti-corrosion	Anti-corrosion
Fan	Type		-	Turbo Fan	Turbo Fan	Turbo Fan
	Quantity		ea	1	1	1
	Air Flow Rate	H/M/L (UL)	m ³ /min	26.0 / 24.0 / 22.0	28.0 / 26.0 / 23.0	30.0 / 28.0 / 26.0
			l/s	433 / 400 / 367	467 / 433 / 383	500 / 467 / 433
Fan Motor	Model		-	BLDC Motor	BLDC Motor	BLDC Motor
	Output x n		W	65 x1	97 x1	97 x1
Piping Connections	Liquid Pipe	Type	-	Flare connection	Flare connection	Flare connection
		Φ, mm	-	9.52	9.52	9.52
		Φ, inch	-	3/8"	3/8"	3/8"
	Gas Pipe	Type	-	Flare connection	Flare connection	Flare connection
		Φ, mm	-	15.88	15.88	15.88
		Φ, inch	-	5/8"	5/8"	5/8"
	Drain Pipe		Φ, mm	VP25 (OD 32,ID 25)	VP25 (OD 32,ID 25)	VP25 (OD 32,ID 25)
Wiring connections	For power supply	Minimum	mm ²	1.5	1.5	1.5
	For connection with indoor	Minimum	mm ²	0.75	0.75	0.75
		Remark	-	-	F1,F2	F1,F2
Refrigerant	Type		-	R410A	R410A	R410A
	Control Method		-	EEV Included	EEV Included	EEV Included
Sound	Sound Pressure	High / Mid / Low	dB(A)	40 / 38 / 35	42 / 40 / 35	44 / 41 / 35
	Sound Power	Cooling (Nominal)		57	58	60
Dimension	Net Weight		kg	17	19	19
	Shipping Weight		kg	20.0	22.5	22.5
	Net Dimensions (WxHxD)		mm	840 x 246 x 840	840 x 288 x 840	840 x 288 x 840
	Shipping Dimensions (WxHxD)		mm	898 x 316 x 898	898 x 357 x 898	898 x 357 x 898

1. Specification

Type			4Way Cassette	4Way Cassette	4Way Cassette
Model Name			AM112FN4DEH***	AM128FN4DEH***	AM140FN4DEH***
Air filter	Type	-	Washable	Washable	Washable
Panel Size	Panel model	-	PC4NUSKAN	PC4NUSKAN	PC4NUSKAN
	Panel Net Weight	kg	5.80	5.80	5.80
	Shipping Weight	kg	8.4	8.4	8.4
	Net Dimensions (W×H×D)	mm	950 x 45 x 950	950 x 45 x 950	950 x 45 x 950
	Shipping Dimensions (W×H×D)	mm	1,005 x 100 x 1,005	1,005 x 100 x 1,005	1,005 x 100 x 1,005
Drain pump		-	Included	Included	Included
	Max. lifting Height	mm	750	750	750

NOTE

- Mode : HP(Heat Pump), HR(Heat Recovery)
 - Nominal Cooling : Indoor temperature 27°C DB / 19°C WB, Outdoor temperature 35°C DB/24°C WB, Refrigerant pipe length 7.5m, Level difference 0m.
 - Nominal Heating : Indoor temperature 20°C DB / 15°C WB, Outdoor temperature 7°C DB / 6°C WB, Refrigerant pipe length 7.5m, Level difference 0m.
 - Sound level was acquired in an anechoic room. Thus actual noise level may be different depending on the installation conditions.
 - These products contain R410A which is fluorinated greenhouse gas.
 - Specifications may be subject to change without prior notice.
 - Select wire size based on the value of MCA
 - Drain pump included (check valve included)
-

2. Summary Table

Performance Characteristics

Model Code	Net Weight (kg)	Fan Speed	Nominal Capacity			Airflow (CMM)	Sound Pressure (dBA)	Sound Power (dBA)
			Cooling (kW)	Sensible (Kw)	Heating (kW)			
AM045FN4DEHXXX	15.5	High	4.5	3.3	5.0	14.5	33	49
		Mid	3.3	2.6	4.8	13.5	32	-
		Low	2.7	2.3	4.6	12.5	30	-
AM056FN4DEHXXX	15.5	High	5.6	4.2	6.3	15.0	33	50
		Mid	4	3.2	6.1	14.0	32	-
		Low	3.3	2.8	5.9	13.0	30	-
AM071FN4DEHXXX	15.5	High	7.1	5.4	8.0	17.0	35	54
		Mid	5	4	7.6	15.5	34	-
		Low	4.1	3.4	7.4	14.5	33	-
AM090FN4DEHXXX	15.5	High	9.0	7.1	10.0	19.5	39	57
		Mid	6.3	5.2	9.6	18.0	36	-
		Low	5.1	4.4	9.2	16.5	33	-
AM112FN4DEHXXX	17	High	11.2	8.6	12.5	26.0	40	57
		Mid	7.8	6.2	12.0	24.0	38	-
		Low	6.3	5.3	11.5	22.0	35	-
AM128FN4DEHXXX	19	High	12.8	9.9	13.8	28.0	42	58
		Mid	8.3	7.2	13.3	26.0	40	-
		Low	7.2	6	12.5	23.0	35	-
AM140FN4DEHXXX	19	High	14.0	10.8	16.0	30.0	44	60
		Mid	9.7	7.8	15.5	28.0	41	-
		Low	7.8	6.6	14.9	26.0	35	-

Electrical Characteristics

Model	Power Supply (Φ, #, V, Hz)	Power Input (W)	Current Input (A)	MCA (A)	MFA (A)	FLA (A)
AM045FN4DEHXXX	1, 2, 220-240, 50	32.0	0.22	0.3	15	0.23
AM056FN4DEHXXX	1, 2, 220-240, 50	32.0	0.22	0.3	15	0.23
AM071FN4DEHXXX	1, 2, 220-240, 50	45.0	0.31	0.4	15	0.33
AM090FN4DEHXXX	1, 2, 220-240, 50	62.0	0.43	0.6	15	0.45
AM112FN4DEHXXX	1, 2, 220-240, 50	78.0	0.55	0.9	15	0.74
AM128FN4DEHXXX	1, 2, 220-240, 50	73.0	0.51	0.8	15	0.64
AM140FN4DEHXXX	1, 2, 220-240, 50	89.0	0.62	0.9	15	0.74

NOTE

- MCA : Minimum circuit amperes
- FLA : Full load amperes

3. Capacity Table

Cooling

TC : Total Capacity (kW), SHC : Sensible Heat Capacity (kW)

Capacity Index	Outdoor Air Temp. (°C, DB)	Indoor temperature													
		20(°C, DB)		23(°C, DB)		26(°C, DB)		27(°C, DB)		28(°C, DB)		30(°C, DB)		32(°C, DB)	
		14(°C, WB)		16(°C, WB)		18(°C, WB)		19(°C, WB)		20(°C, WB)		22(°C, WB)		24(°C, WB)	
	TC	SHC	TC	SHC	TC	SHC	TC	SHC	TC	SHC	TC	SHC	TC	SHC	
045	10	3.1	2.7	3.7	2.8	4.2	3.0	4.5	3.1	4.7	3.1	5.0	3.1	5.4	2.9
	12	3.1	2.7	3.7	2.8	4.2	3.0	4.5	3.1	4.7	3.1	5.0	3.1	5.4	2.9
	14	3.1	2.7	3.7	2.8	4.2	3.0	4.5	3.1	4.7	3.1	5.0	3.1	5.4	2.9
	16	3.1	2.7	3.7	2.8	4.2	3.0	4.5	3.1	4.7	3.1	5.0	3.1	5.3	2.8
	18	3.1	2.7	3.7	2.8	4.2	3.0	4.5	3.1	4.7	3.1	5.0	3.1	5.3	2.8
	20	3.1	2.7	3.7	2.8	4.2	3.0	4.5	3.1	4.7	3.1	5.0	3.1	5.3	2.8
	21	3.1	2.7	3.7	2.8	4.2	3.0	4.5	3.1	4.7	3.1	5.0	3.1	5.3	2.8
	23	3.1	2.7	3.7	2.8	4.2	3.0	4.5	3.1	4.7	3.1	5.0	3.1	5.3	2.8
	25	3.1	2.7	3.7	2.8	4.2	3.0	4.5	3.1	4.7	3.1	5.0	3.1	5.3	2.8
	27	3.1	2.7	3.7	2.8	4.2	3.0	4.5	3.1	4.7	3.1	5.0	3.1	5.3	2.8
	29	3.1	2.7	3.7	2.8	4.2	3.0	4.5	3.1	4.7	3.1	5.0	3.1	5.3	2.8
	31	3.1	2.7	3.7	2.8	4.2	3.0	4.5	3.1	4.7	3.1	5.0	3.1	5.3	2.8
	33	3.1	2.7	3.7	2.8	4.2	3.0	4.5	3.1	4.7	3.1	5.0	3.1	5.3	2.8
	35	3.1	2.7	3.7	2.8	4.2	3.0	4.5	3.1	4.7	3.1	5.0	3.1	5.3	2.8
	37	3.1	2.7	3.7	2.8	4.2	3.0	4.5	3.1	4.6	3.0	4.9	3.0	5.2	2.7
	39	3.1	2.7	3.7	2.8	4.2	3.0	4.5	3.1	4.6	3.0	4.9	3.0	5.1	2.6
42	3.1	2.7	3.7	2.8	4.2	3.0	4.4	3.1	4.5	3.0	4.8	2.9	5.0	2.5	
44	3.1	2.7	3.7	2.8	4.1	2.9	4.3	3.0	4.4	2.9	4.6	2.8	4.8	2.4	
46	3.1	2.7	3.7	2.8	4.0	2.9	4.2	2.9	4.3	2.8	4.5	2.7	4.7	2.4	
48	3.1	2.7	3.6	2.7	3.9	2.8	4.0	2.8	4.2	2.7	4.3	2.7	4.5	2.3	
056	10	3.9	3.2	4.6	3.5	5.3	3.9	5.6	3.9	5.8	3.9	6.3	3.9	6.7	3.7
	12	3.9	3.2	4.6	3.5	5.3	3.9	5.6	3.9	5.8	3.9	6.3	3.9	6.7	3.7
	14	3.9	3.2	4.6	3.5	5.3	3.9	5.6	3.9	5.8	3.9	6.2	3.8	6.7	3.7
	16	3.9	3.2	4.6	3.5	5.3	3.9	5.6	3.9	5.8	3.9	6.2	3.8	6.6	3.6
	18	3.9	3.2	4.6	3.5	5.3	3.9	5.6	3.9	5.8	3.9	6.2	3.8	6.6	3.6
	20	3.9	3.2	4.6	3.5	5.3	3.9	5.6	3.9	5.8	3.9	6.2	3.8	6.6	3.6
	21	3.9	3.2	4.6	3.5	5.3	3.9	5.6	3.9	5.8	3.9	6.2	3.8	6.6	3.6
	23	3.9	3.2	4.6	3.5	5.3	3.9	5.6	3.9	5.8	3.9	6.2	3.8	6.6	3.6
	25	3.9	3.2	4.6	3.5	5.3	3.9	5.6	3.9	5.8	3.9	6.2	3.8	6.6	3.6
	27	3.9	3.2	4.6	3.5	5.3	3.9	5.6	3.9	5.8	3.9	6.2	3.8	6.6	3.6
	29	3.9	3.2	4.6	3.5	5.3	3.9	5.6	3.9	5.8	3.9	6.2	3.8	6.6	3.6
	31	3.9	3.2	4.6	3.5	5.3	3.9	5.6	3.9	5.8	3.9	6.2	3.8	6.6	3.6
	33	3.9	3.2	4.6	3.5	5.3	3.9	5.6	3.9	5.8	3.9	6.2	3.8	6.6	3.6
	35	3.9	3.2	4.6	3.5	5.3	3.9	5.6	3.9	5.8	3.9	6.2	3.8	6.6	3.6
	37	3.9	3.2	4.6	3.5	5.3	3.9	5.6	3.9	5.8	3.9	6.2	3.8	6.6	3.5
	39	3.9	3.2	4.6	3.5	5.3	3.9	5.6	3.9	5.8	3.9	6.2	3.8	6.6	3.4
42	3.9	3.2	4.6	3.5	5.3	3.9	5.5	3.8	5.7	3.9	6.1	3.7	6.4	3.3	
44	3.9	3.2	4.6	3.5	5.1	3.8	5.3	3.7	5.6	3.7	5.9	3.6	6.2	3.2	
46	3.9	3.2	4.6	3.5	5.0	3.7	5.2	3.6	5.4	3.6	5.7	3.5	6.0	3.1	
48	3.9	3.2	4.5	3.4	5.0	3.6	5.0	3.5	5.3	3.6	5.5	3.4	5.8	3.0	
071	10	4.9	4.0	5.8	4.5	6.7	4.8	7.1	5.0	7.4	5.0	8.0	5.1	8.5	4.8
	12	4.9	4.0	5.8	4.5	6.7	4.8	7.1	5.0	7.4	5.0	7.9	5.0	8.5	4.8
	14	4.9	4.0	5.8	4.5	6.7	4.8	7.1	5.0	7.4	5.0	7.9	5.0	8.5	4.8
	16	4.9	4.0	5.8	4.5	6.7	4.8	7.1	5.0	7.4	5.0	7.9	5.0	8.4	4.8
	18	4.9	4.0	5.8	4.5	6.7	4.8	7.1	5.0	7.4	5.0	7.9	5.0	8.4	4.8
	20	4.9	4.0	5.8	4.5	6.7	4.8	7.1	5.0	7.4	5.0	7.9	5.0	8.4	4.8
	21	4.9	4.0	5.8	4.5	6.7	4.8	7.1	5.0	7.4	5.0	7.9	5.0	8.4	4.8
	23	4.9	4.0	5.8	4.5	6.7	4.8	7.1	5.0	7.4	5.0	7.9	5.0	8.4	4.8
	25	4.9	4.0	5.8	4.5	6.7	4.8	7.1	5.0	7.4	5.0	7.9	5.0	8.4	4.8
	27	4.9	4.0	5.8	4.5	6.7	4.8	7.1	5.0	7.4	5.0	7.9	5.0	8.4	4.8
	29	4.9	4.0	5.8	4.5	6.7	4.8	7.1	5.0	7.4	5.0	7.9	5.0	8.4	4.8
	31	4.9	4.0	5.8	4.5	6.7	4.8	7.1	5.0	7.4	5.0	7.9	5.0	8.4	4.8
	33	4.9	4.0	5.8	4.5	6.7	4.8	7.1	5.0	7.4	5.0	7.9	5.0	8.4	4.8
	35	4.9	4.0	5.8	4.5	6.7	4.8	7.1	5.0	7.4	5.0	7.9	5.0	8.4	4.8
	37	4.9	4.0	5.8	4.5	6.7	4.8	7.1	5.0	7.3	4.9	7.8	4.9	8.2	4.7
	39	4.9	4.0	5.8	4.5	6.7	4.8	7.1	5.0	7.3	4.9	7.7	4.8	8.1	4.6
42	4.9	4.0	5.8	4.5	6.7	4.8	7.0	4.9	7.2	4.8	7.6	4.7	7.9	4.5	
44	4.9	4.0	5.8	4.5	6.5	4.6	6.8	4.8	7.0	4.7	7.3	4.5	7.6	4.3	
46	4.9	4.0	5.7	4.5	6.4	4.6	6.6	4.6	6.8	4.6	7.0	4.4	7.4	4.2	
48	4.8	3.9	5.7	4.4	6.3	4.5	6.4	4.5	6.7	4.5	6.8	4.3	7.2	4.1	

3. Capacity Table

Cooling

TC : Total Capacity (kW), SHC : Sensible Heat Capacity (kW)

Capacity Index	Outdoor Air Temp. (°C, DB)	Indoor temperature													
		20(°C, DB)		23(°C, DB)		26(°C, DB)		27(°C, DB)		28(°C, DB)		30(°C, DB)		32(°C, DB)	
		14(°C, WB)		16(°C, WB)		18(°C, WB)		19(°C, WB)		20(°C, WB)		22(°C, WB)		24(°C, WB)	
	TC	SHC	TC	SHC	TC	SHC	TC	SHC	TC	SHC	TC	SHC	TC	SHC	
090	10	6.2	5.2	7.3	5.7	8.4	6.3	9.0	6.3	9.4	6.3	10.1	6.3	10.8	6.3
	12	6.2	5.2	7.3	5.7	8.4	6.3	9.0	6.3	9.4	6.3	10.1	6.3	10.8	6.3
	14	6.2	5.2	7.3	5.7	8.4	6.3	9.0	6.3	9.3	6.3	10.0	6.2	10.7	6.2
	16	6.2	5.2	7.3	5.7	8.4	6.3	9.0	6.3	9.3	6.3	10.0	6.2	10.7	6.2
	18	6.2	5.2	7.3	5.7	8.4	6.3	9.0	6.3	9.3	6.3	10.0	6.2	10.6	6.1
	20	6.2	5.2	7.3	5.7	8.4	6.3	9.0	6.3	9.3	6.3	10.0	6.2	10.6	6.1
	21	6.2	5.2	7.3	5.7	8.4	6.3	9.0	6.3	9.3	6.3	10.0	6.2	10.6	6.1
	23	6.2	5.2	7.3	5.7	8.4	6.3	9.0	6.3	9.3	6.3	10.0	6.2	10.6	6.1
	25	6.2	5.2	7.3	5.7	8.4	6.3	9.0	6.3	9.3	6.3	10.0	6.2	10.6	6.1
	27	6.2	5.2	7.3	5.7	8.4	6.3	9.0	6.3	9.3	6.3	10.0	6.2	10.6	6.1
	29	6.2	5.2	7.3	5.7	8.4	6.3	9.0	6.3	9.3	6.3	10.0	6.2	10.6	6.1
	31	6.2	5.2	7.3	5.7	8.4	6.3	9.0	6.3	9.3	6.3	10.0	6.2	10.6	6.1
	33	6.2	5.2	7.3	5.7	8.4	6.3	9.0	6.3	9.3	6.3	10.0	6.2	10.6	6.1
	35	6.2	5.2	7.3	5.7	8.4	6.3	9.0	6.3	9.3	6.3	10.0	6.2	10.6	6.1
	37	6.2	5.2	7.3	5.7	8.4	6.3	9.0	6.3	9.3	6.3	9.9	6.1	10.4	6.0
	39	6.2	5.2	7.3	5.7	8.4	6.3	9.0	6.4	9.2	6.2	9.7	6.0	10.2	5.9
42	6.2	5.2	7.3	5.7	8.3	6.3	8.9	6.3	9.1	6.1	9.5	5.9	9.9	5.8	
44	6.2	5.2	7.3	5.7	8.1	6.1	8.6	6.1	8.8	6.0	9.2	5.7	9.6	5.6	
46	6.2	5.2	7.2	5.6	8.0	6.0	8.3	5.9	8.6	5.8	8.9	5.5	9.3	5.4	
48	6.1	5.1	7.1	5.6	7.8	5.9	8.1	5.8	8.4	5.7	8.6	5.3	9.0	5.2	
112	10	7.7	6.4	9.1	7.1	10.5	7.8	11.2	7.9	11.6	7.9	12.5	7.9	13.4	7.9
	12	7.7	6.4	9.1	7.1	10.5	7.8	11.2	7.9	11.6	7.9	12.5	7.9	13.4	7.9
	14	7.7	6.4	9.1	7.1	10.5	7.8	11.2	7.9	11.6	7.9	12.5	7.9	13.3	7.8
	16	7.7	6.4	9.1	7.1	10.5	7.8	11.2	7.9	11.6	7.9	12.5	7.9	13.3	7.8
	18	7.7	6.4	9.1	7.1	10.5	7.8	11.2	7.9	11.6	7.9	12.4	7.9	13.2	7.7
	20	7.7	6.4	9.1	7.1	10.5	7.8	11.2	7.9	11.6	7.9	12.4	7.9	13.2	7.7
	21	7.7	6.4	9.1	7.1	10.5	7.8	11.2	7.9	11.6	7.9	12.4	7.9	13.2	7.7
	23	7.7	6.4	9.1	7.1	10.5	7.8	11.2	7.9	11.6	7.9	12.4	7.9	13.2	7.7
	25	7.7	6.4	9.1	7.1	10.5	7.8	11.2	7.9	11.6	7.9	12.4	7.9	13.2	7.7
	27	7.7	6.4	9.1	7.1	10.5	7.8	11.2	7.9	11.6	7.9	12.4	7.9	13.2	7.7
	29	7.7	6.4	9.1	7.1	10.5	7.8	11.2	7.9	11.6	7.9	12.4	7.9	13.2	7.7
	31	7.7	6.4	9.1	7.1	10.5	7.8	11.2	7.9	11.6	7.9	12.4	7.9	13.2	7.7
	33	7.7	6.3	9.1	7.0	10.5	7.8	11.2	7.9	11.6	7.9	12.4	7.9	13.2	7.7
	35	7.7	6.3	9.1	7.0	10.5	7.8	11.2	7.9	11.6	7.9	12.4	7.9	13.2	7.7
	37	7.7	6.3	9.1	7.0	10.5	7.8	11.2	7.9	11.6	7.9	12.3	7.8	13.0	7.6
	39	7.7	6.3	9.1	7.0	10.5	7.8	11.2	8.0	11.5	7.8	12.1	7.7	12.7	7.5
42	7.7	6.3	9.1	7.0	10.4	7.7	11.1	7.9	11.4	7.7	11.9	7.6	12.4	7.3	
44	7.7	6.3	9.1	7.0	10.1	7.5	10.7	7.6	11.0	7.5	11.4	7.3	12.0	7.1	
46	7.7	6.3	9.0	6.9	10.0	7.4	10.4	7.4	10.7	7.3	11.0	7.0	11.6	6.9	
48	7.6	6.2	8.9	6.8	9.8	7.3	10.1	7.2	10.5	7.1	10.7	6.8	11.2	6.6	
128	10	8.8	7.3	10.4	8.1	12.0	9.0	12.8	9.1	13.3	9.1	14.3	9.1	15.4	9.1
	12	8.8	7.3	10.4	8.1	12.0	9.0	12.8	9.1	13.3	9.1	14.3	9.1	15.3	9.0
	14	8.8	7.3	10.4	8.1	12.0	9.0	12.8	9.1	13.3	9.1	14.3	9.1	15.3	9.0
	16	8.8	7.3	10.4	8.1	12.0	9.0	12.8	9.1	13.3	9.1	14.2	9.0	15.2	8.9
	18	8.8	7.3	10.4	8.1	12.0	9.0	12.8	9.1	13.3	9.1	14.2	9.0	15.1	8.8
	20	8.8	7.3	10.4	8.1	12.0	9.0	12.8	9.1	13.3	9.1	14.2	9.0	15.1	8.8
	21	8.8	7.3	10.4	8.1	12.0	9.0	12.8	9.1	13.3	9.1	14.2	9.0	15.1	8.8
	23	8.8	7.3	10.4	8.1	12.0	9.0	12.8	9.1	13.3	9.1	14.2	9.0	15.1	8.8
	25	8.8	7.3	10.4	8.1	12.0	9.0	12.8	9.1	13.3	9.1	14.2	9.0	15.1	8.8
	27	8.8	7.3	10.4	8.1	12.0	9.0	12.8	9.1	13.3	9.1	14.2	9.0	15.1	8.8
	29	8.8	7.3	10.4	8.1	12.0	9.0	12.8	9.1	13.3	9.1	14.2	9.0	15.1	8.8
	31	8.8	7.3	10.4	8.1	12.0	9.0	12.8	9.1	13.3	9.1	14.2	9.0	15.1	8.8
	33	8.8	7.3	10.4	8.1	12.0	9.0	12.8	9.1	13.3	9.1	14.2	9.0	15.1	8.8
	35	8.8	7.3	10.4	8.1	12.0	9.0	12.8	9.1	13.3	9.1	14.2	9.0	15.1	8.8
	37	8.8	7.3	10.4	8.1	12.0	9.0	12.8	9.1	13.2	9.0	14.0	8.9	14.9	8.7
	39	8.8	7.3	10.4	8.1	12.0	9.0	12.8	9.2	13.1	8.9	13.8	8.8	14.5	8.6
42	8.8	7.3	10.4	8.1	11.9	8.9	12.6	9.1	12.9	8.8	13.6	8.6	14.1	8.4	
44	8.8	7.3	10.4	8.1	11.6	8.7	12.2	8.8	12.6	8.5	13.0	8.3	13.6	8.1	
46	8.8	7.3	10.3	8.0	11.4	8.6	11.8	8.5	12.2	8.3	12.6	8.0	13.3	7.9	
48	8.7	7.2	10.2	7.9	11.2	8.4	11.5	8.3	12.0	8.1	12.2	7.8	12.8	7.6	

3. Capacity Table

Cooling

TC : Total Capacity (kW), SHC : Sensible Heat Capacity (kW)

Capacity Index	Outdoor Air Temp. (°C, DB)	Indoor temperature													
		20(°C, DB)		23(°C, DB)		26(°C, DB)		27(°C, DB)		28(°C, DB)		30(°C, DB)		32(°C, DB)	
		14(°C, WB)		16(°C, WB)		18(°C, WB)		19(°C, WB)		20(°C, WB)		22(°C, WB)		24(°C, WB)	
		TC	SHC	TC	SHC	TC	SHC	TC	SHC	TC	SHC	TC	SHC	TC	SHC
140	10	9.7	7.7	11.4	8.5	13.1	9.4	14.0	9.6	14.6	9.6	15.7	9.5	16.8	9.7
	12	9.7	7.7	11.4	8.5	13.1	9.4	14.0	9.6	14.5	9.6	15.6	9.6	16.7	9.6
	14	9.7	7.7	11.4	8.5	13.1	9.4	14.0	9.6	14.5	9.6	15.6	9.6	16.7	9.6
	16	9.7	7.7	11.4	8.5	13.1	9.4	14.0	9.6	14.5	9.6	15.6	9.6	16.6	9.5
	18	9.7	7.7	11.4	8.5	13.1	9.4	14.0	9.6	14.5	9.6	15.5	9.5	16.6	9.5
	20	9.7	7.7	11.4	8.5	13.1	9.4	14.0	9.6	14.5	9.6	15.5	9.5	16.5	9.4
	21	9.7	7.7	11.4	8.5	13.1	9.4	14.0	9.6	14.5	9.6	15.5	9.5	16.5	9.4
	23	9.7	7.7	11.4	8.5	13.1	9.4	14.0	9.6	14.5	9.6	15.5	9.5	16.5	9.4
	25	9.7	7.7	11.4	8.5	13.1	9.4	14.0	9.6	14.5	9.6	15.5	9.5	16.5	9.4
	27	9.7	7.7	11.4	8.5	13.1	9.4	14.0	9.6	14.5	9.6	15.5	9.5	16.5	9.4
	29	9.7	7.7	11.4	8.5	13.1	9.4	14.0	9.6	14.5	9.6	15.5	9.5	16.5	9.4
	31	9.7	7.7	11.4	8.5	13.1	9.4	14.0	9.6	14.5	9.6	15.5	9.5	16.5	9.4
	33	9.7	7.7	11.4	8.5	13.1	9.4	14.0	9.6	14.5	9.6	15.5	9.5	16.5	9.4
	35	9.7	7.7	11.4	8.5	13.1	9.4	14.0	9.6	14.5	9.6	15.5	9.5	16.5	9.4
	37	9.7	7.7	11.4	8.5	13.1	9.4	14.0	9.6	14.5	9.6	15.4	9.4	16.3	9.2
	39	9.7	7.7	11.4	8.5	13.1	9.4	14.0	9.6	14.4	9.4	15.1	9.3	15.9	9.0
	42	9.7	7.7	11.4	8.5	13.0	9.3	13.8	9.5	14.2	9.3	14.8	9.1	15.5	8.8
44	9.7	7.7	11.4	8.5	12.7	9.1	13.4	9.2	13.8	9.0	14.2	8.8	15.0	8.5	
46	9.7	7.7	11.3	8.4	12.4	8.9	12.9	8.9	13.4	8.8	13.8	8.5	14.6	8.2	
48	9.6	7.6	11.1	8.3	12.2	8.8	12.6	8.6	13.1	8.6	13.4	8.2	14.1	8.0	

3. Capacity Table

Heating

TC : Total Capacity (kW)

Capacity Index	Outdoor Air Temp. (°C)		Indoor temperature (°C,DB)				
			16(°C,DB)	18(°C,DB)	20(°C,DB)	22(°C,DB)	24(°C,DB)
	DB	WB	TC kW	TC kW	TC kW	TC kW	TC kW
045	-19.8	-20.0	3.1	3.1	2.9	2.9	2.9
	-18.8	-19.0	3.1	3.1	3.0	2.9	2.9
	-16.7	-17.0	3.2	3.2	3.1	3.0	3.0
	-14.7	-15.0	3.3	3.3	3.2	3.1	3.0
	-12.6	-13.0	3.5	3.4	3.4	3.3	3.2
	-10.5	-11.0	3.7	3.6	3.6	3.5	3.4
	-9.5	-10.0	3.7	3.6	3.6	3.5	3.5
	-8.5	-9.1	3.8	3.7	3.7	3.6	3.6
	-7.0	-7.6	3.9	3.8	3.8	3.7	3.6
	-5.0	-5.6	4.1	4.0	4.0	3.9	3.7
	-3.0	-3.7	4.3	4.2	4.2	4.0	3.9
	0.0	-0.7	4.5	4.4	4.4	4.2	4.0
	3.0	2.2	4.7	4.7	4.6	4.4	4.2
	5.0	4.1	4.9	4.9	4.8	4.5	4.2
	7.0	6.0	5.1	5.1	5.0	4.6	4.2
9.0	7.9	5.3	5.2	5.0	4.6	4.2	
11.0	9.8	5.5	5.2	5.0	4.6	4.2	
13.0	11.8	5.6	5.3	5.0	4.6	4.2	
15.0	13.7	5.8	5.4	5.0	4.6	4.2	
056	-19.8	-20.0	3.9	3.8	3.8	3.7	3.7
	-18.8	-19.0	3.9	3.9	3.8	3.7	3.7
	-16.7	-17.0	4.0	4.0	3.9	3.8	3.8
	-14.7	-15.0	4.2	4.1	4.0	3.9	3.8
	-12.6	-13.0	4.4	4.3	4.2	4.1	4.0
	-10.5	-11.0	4.6	4.5	4.4	4.4	4.3
	-9.5	-10.0	4.7	4.6	4.6	4.5	4.4
	-8.5	-9.1	4.8	4.7	4.7	4.6	4.5
	-7.0	-7.6	4.9	4.8	4.8	4.7	4.5
	-5.0	-5.6	5.2	5.1	5.0	4.9	4.7
	-3.0	-3.7	5.4	5.3	5.3	5.1	4.9
	0.0	-0.7	5.7	5.6	5.5	5.3	5.0
	3.0	2.2	5.9	5.9	5.8	5.6	5.3
	5.0	4.1	6.2	6.1	6.0	5.7	5.3
	7.0	6.0	6.5	6.4	6.3	5.8	5.3
9.0	7.9	6.7	6.5	6.3	5.8	5.3	
11.0	9.8	6.9	6.6	6.3	5.8	5.3	
13.0	11.8	7.1	6.7	6.3	5.8	5.3	
15.0	13.7	7.3	6.8	6.3	5.8	5.3	
071	-19.8	-20.0	4.9	4.9	4.8	4.7	4.7
	-18.8	-19.0	5.0	4.9	4.8	4.7	4.7
	-16.7	-17.0	5.1	5.0	4.9	4.8	4.8
	-14.7	-15.0	5.3	5.2	5.1	4.9	4.8
	-12.6	-13.0	5.5	5.4	5.3	5.2	5.1
	-10.5	-11.0	5.8	5.7	5.6	5.5	5.5
	-9.5	-10.0	6.0	5.9	5.8	5.7	5.6
	-8.5	-9.1	6.1	6.0	5.9	5.8	5.7
	-7.0	-7.6	6.2	6.1	6.0	5.9	5.8
	-5.0	-5.6	6.5	6.5	6.4	6.2	6.0
	-3.0	-3.7	6.9	6.8	6.7	6.4	6.2
	0.0	-0.7	7.2	7.1	7.0	6.7	6.4
	3.0	2.2	7.6	7.5	7.3	7.1	6.8
	5.0	4.1	7.9	7.8	7.7	7.2	6.8
	7.0	6.0	8.2	8.1	8.0	7.4	6.8
9.0	7.9	8.5	8.2	8.0	7.4	6.8	
11.0	9.8	8.7	8.4	8.0	7.4	6.8	
13.0	11.8	9.0	8.5	8.0	7.4	6.8	
15.0	13.7	9.2	8.6	8.0	7.4	6.8	

3. Capacity Table

Heating

TC : Total Capacity (kW)

Capacity Index	Outdoor Air Temp. (°C)		Indoor temperature (°C,DB)				
			16(°C,DB)	18(°C,DB)	20(°C,DB)	22(°C,DB)	24(°C,DB)
	DB	WB	TC kW	TC kW	TC kW	TC kW	TC kW
090	-19.8	-20.0	6.0	6.0	5.9	5.8	5.8
	-18.8	-19.0	6.1	6.1	6.0	5.9	5.8
	-16.7	-17.0	6.4	6.3	6.1	6.0	5.9
	-14.7	-15.0	6.7	6.5	6.3	6.2	6.1
	-12.6	-13.0	6.9	6.8	6.6	6.5	6.4
	-10.5	-11.0	7.2	7.1	7.0	6.9	6.9
	-9.5	-10.0	7.4	7.3	7.2	7.1	7.0
	-8.5	-9.1	7.6	7.5	7.4	7.2	7.1
	-7.0	-7.6	7.8	7.7	7.6	7.4	7.2
	-5.0	-5.6	8.2	8.1	8.0	7.7	7.5
	-3.0	-3.7	8.6	8.5	8.4	8.1	7.7
	0.0	-0.7	9.0	8.9	8.8	8.4	8.0
	3.0	2.2	9.4	9.3	9.2	8.8	8.4
	5.0	4.1	9.9	9.7	9.6	9.0	8.4
	7.0	6.0	10.3	10.1	10.0	9.2	8.4
9.0	7.9	10.6	10.3	10.0	9.2	8.4	
11.0	9.8	10.9	10.5	10.0	9.2	8.4	
13.0	11.8	11.2	10.6	10.0	9.2	8.4	
15.0	13.7	11.6	10.8	10.0	9.2	8.4	
112	-19.8	-20.0	7.4	7.4	7.3	7.3	7.3
	-18.8	-19.0	7.6	7.6	7.4	7.4	7.3
	-16.7	-17.0	8.1	7.8	7.6	7.5	7.4
	-14.7	-15.0	8.4	8.2	8.0	7.8	7.6
	-12.6	-13.0	8.7	8.5	8.3	8.1	8.0
	-10.5	-11.0	9.1	8.9	8.8	8.7	8.6
	-9.5	-10.0	9.3	9.1	9.0	8.9	8.8
	-8.5	-9.1	9.5	9.3	9.2	9.0	8.9
	-7.0	-7.6	9.7	9.6	9.4	9.2	9.0
	-5.0	-5.6	10.2	10.1	9.9	9.6	9.3
	-3.0	-3.7	10.7	10.6	10.5	10.1	9.7
	0.0	-0.7	11.3	11.1	11.1	10.5	10.0
	3.0	2.2	11.8	11.6	11.5	11.0	10.6
	5.0	4.1	12.3	12.2	12.0	11.3	10.6
	7.0	6.0	12.9	12.7	12.5	11.5	10.6
9.0	7.9	13.3	12.9	12.5	11.5	10.6	
11.0	9.8	13.7	13.1	12.5	11.5	10.6	
13.0	11.8	14.0	13.3	12.5	11.5	10.6	
15.0	13.7	14.4	13.5	12.5	11.5	10.6	
128	-19.8	-20.0	8.1	8.1	8.0	8.0	8.0
	-18.8	-19.0	8.3	8.3	8.2	8.1	8.0
	-16.7	-17.0	8.8	8.6	8.4	8.3	8.1
	-14.7	-15.0	9.3	9.1	8.8	8.6	8.3
	-12.6	-13.0	9.6	9.4	9.2	9.0	8.8
	-10.5	-11.0	10.0	9.9	9.8	9.6	9.4
	-9.5	-10.0	10.2	10.1	10.0	9.8	9.7
	-8.5	-9.1	10.4	10.3	10.2	10.0	9.8
	-7.0	-7.6	10.7	10.6	10.4	10.2	10.0
	-5.0	-5.6	11.3	11.1	11.0	10.7	10.3
	-3.0	-3.7	11.9	11.7	11.5	11.1	10.7
	0.0	-0.7	12.4	12.3	12.1	11.6	11.0
	3.0	2.2	13.0	12.9	12.7	12.2	11.7
	5.0	4.1	13.6	13.4	13.2	12.4	11.7
	7.0	6.0	14.2	14.0	13.8	12.7	11.7
9.0	7.9	14.6	14.2	13.8	12.7	11.7	
11.0	9.8	15.1	14.4	13.8	12.7	11.7	
13.0	11.8	15.5	14.7	13.8	12.7	11.7	
15.0	13.7	15.9	14.9	13.8	12.7	11.7	

3. Capacity Table

Heating

TC : Total Capacity (kW)

Capacity Index	Outdoor Air Temp. (°C)		Indoor temperature (°C,DB)				
			16(°C,DB)	18(°C,DB)	20(°C,DB)	22(°C,DB)	24(°C,DB)
	DB	WB	TC kW	TC kW	TC kW	TC kW	TC kW
140	-19.8	-20.0	9.5	9.5	9.4	9.4	9.3
	-18.8	-19.0	9.7	9.7	9.5	9.5	9.3
	-16.7	-17.0	10.2	10.0	9.7	9.6	9.4
	-14.7	-15.0	10.8	10.5	10.2	9.9	9.6
	-12.6	-13.0	11.1	10.9	10.7	10.4	10.1
	-10.5	-11.0	11.6	11.5	11.3	11.1	10.9
	-9.5	-10.0	11.8	11.7	11.5	11.4	11.2
	-8.5	-9.1	12.1	11.9	11.8	11.6	11.3
	-7.0	-7.6	12.4	12.2	12.1	11.8	11.5
	-5.0	-5.6	13.1	12.9	12.7	12.3	12.0
	-3.0	-3.7	13.8	13.6	13.4	12.9	12.4
	0.0	-0.7	14.4	14.2	14.0	13.4	12.8
	3.0	2.2	15.1	14.9	14.7	14.1	13.5
	5.0	4.1	15.8	15.6	15.3	14.4	13.5
	7.0	6.0	16.5	16.2	16.0	14.8	13.5
	9.0	7.9	17.0	16.5	16.0	14.8	13.5
11.0	9.8	17.5	16.7	16.0	14.8	13.5	
13.0	11.8	18.0	17.0	16.0	14.8	13.5	
15.0	13.7	18.5	17.2	16.0	14.8	13.5	

4. Dimensional Drawing

4 Way Casstte

Units : mm [inches]

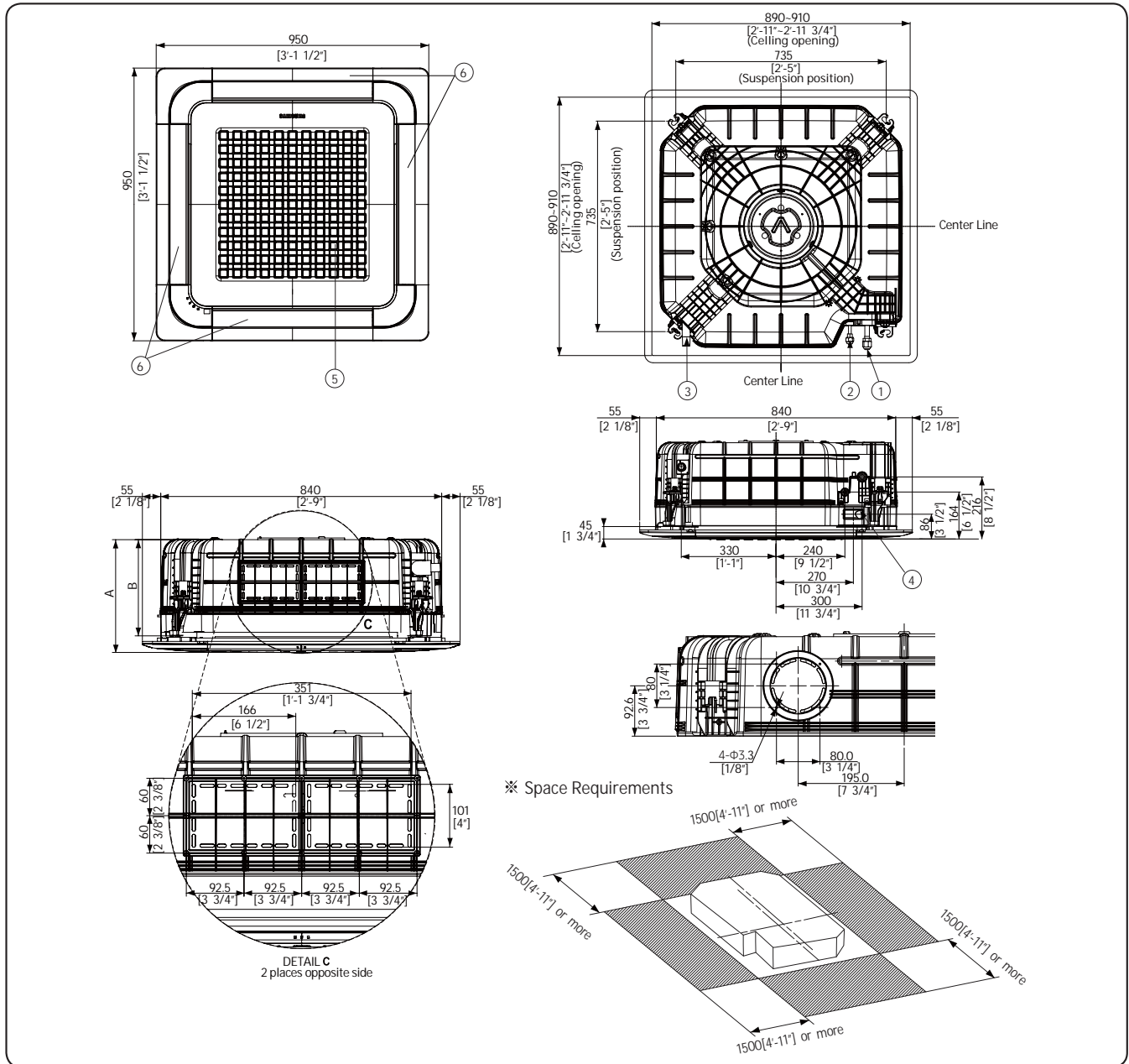

	Description		
	~ 9.0 kW	11.2 kW	12.8 ~ 14kW
A	253	295	337
B	204	246	288

NO	Name	Description	
		~ 5.6 kW	7.1 ~ 14kW
1	Liquid pipe connection	Φ6.35 [1/4"] Flare	Φ9.52 [3/8"] Flare
2	Gas pipe connection	Φ12.7 [1/2"] Flare	Φ15.88 [5/8"] Flare
3	Drain pipe connection	VP25 (OD 32, ID 25)	
4	Conduit for power supply & Communication wiring	-	-
5	Air inlet grille	-	-
6	Air outlet louver	-	-
7	Sub-Duct	-	-

5. Center of Gravity

4 Way Casstte

Units : mm [inches]

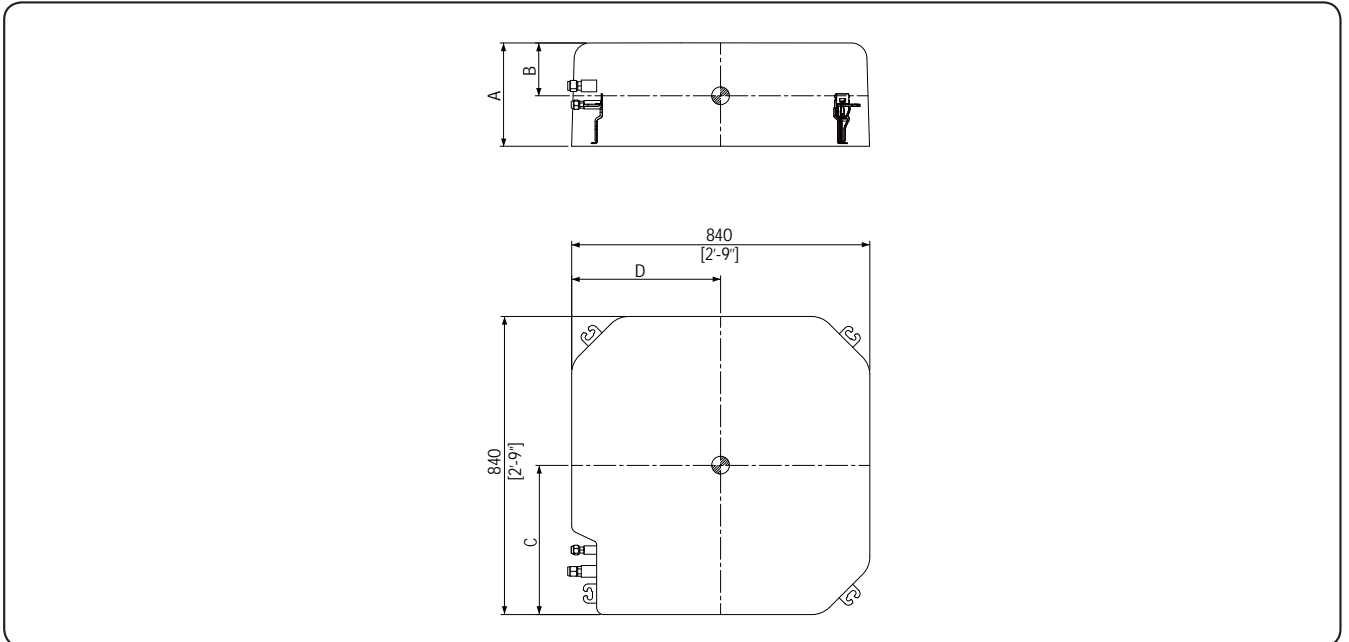

Model	A	B	C	D
~ 9.0 kW	204 [8"]	70 [2 3/4"]	410 [1'-4 1/4"]	360 [1'-2 1/4"]
11.2 kW	246 [9 3/4"]	100 [4"]	410 [1'-4 1/4"]	410 [1'-4 1/4"]
12.8~ 14 kW	288 [11 1/4"]	130 [5"]	420 [1'-4 1/2"]	420 [1'-4 1/2"]

6. Electrical Wiring Diagram

4Way Cassette

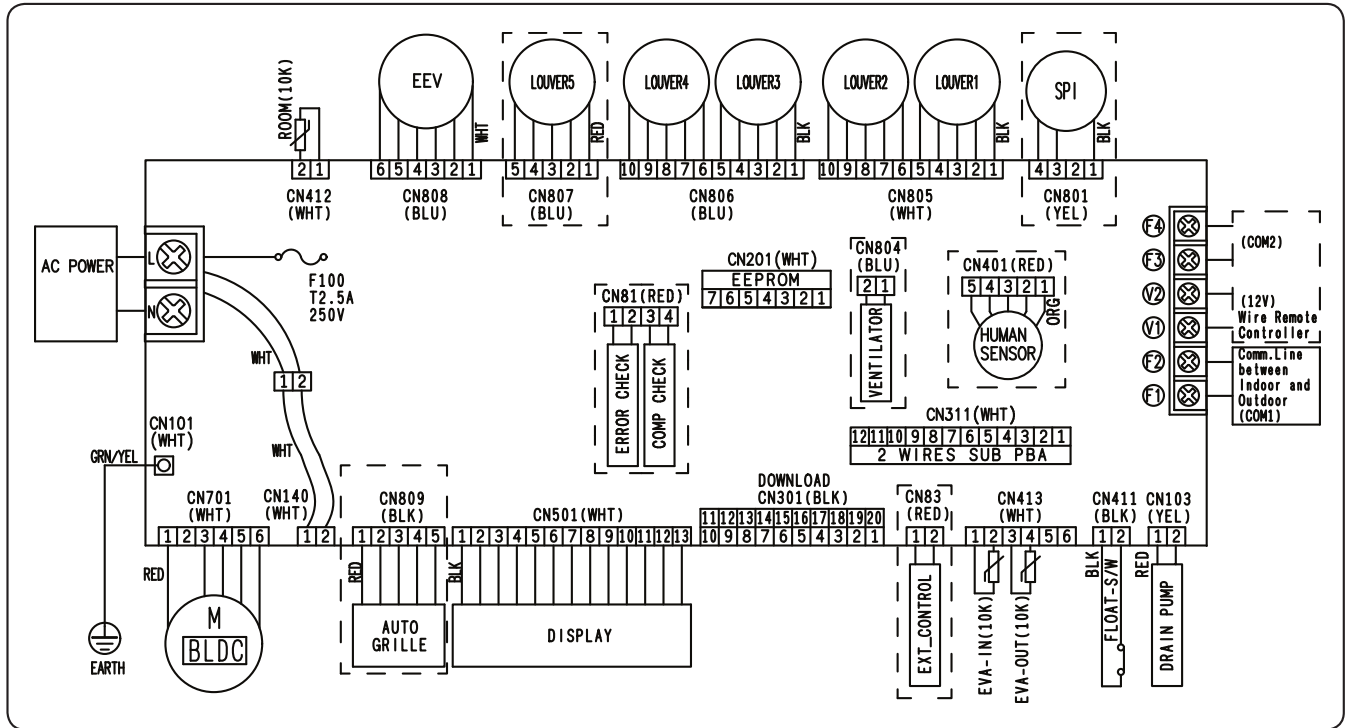

EVA OUT (10K)	Thermistor EVA OUT (10K)	EVA IN (10K)	Thermistor EVA IN (10K)	BLDC	Brush Less Dc Motor
ROOM (10K)	Thermistor ROOM (10K)				

NOTE

- This wiring diagram applies only to the outdoor unit.
- Symbols show as flow :
 blk: black, red: red, blu: blue, wht: white, yel: yellow, brn: brown, sky: skyblue, grn: green
- For connection wiring indoor-outdoor transmission F1-F2, indoor-wired remotecontroller F3-F4.
- ⚡ Protective earth(SCREW)

7. Sound data

4Way Cassette

Sound pressure level

Unit: dB(A)

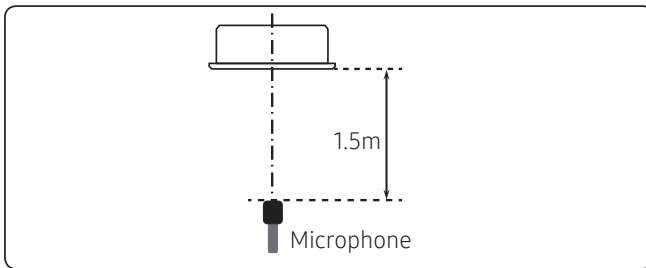

Model	High	Mid	Low
AM045FN4DEH***	33	32	30
AM056FN4DEH***	33	32	30
AM071FN4DEH***	35	34	33
AM090FN4DEH***	39	36	33

- NR Curve

1) AM045FN4DEH***

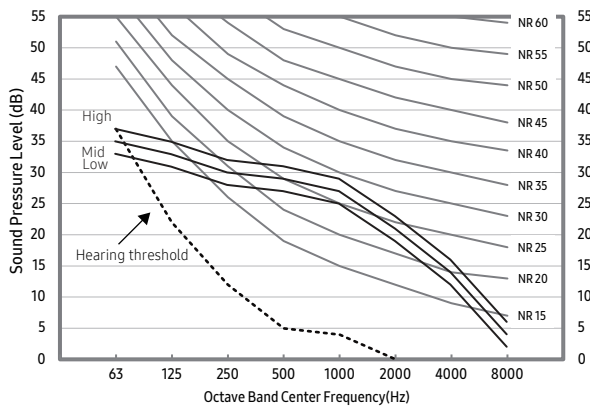

2) AM056FN4DEH***

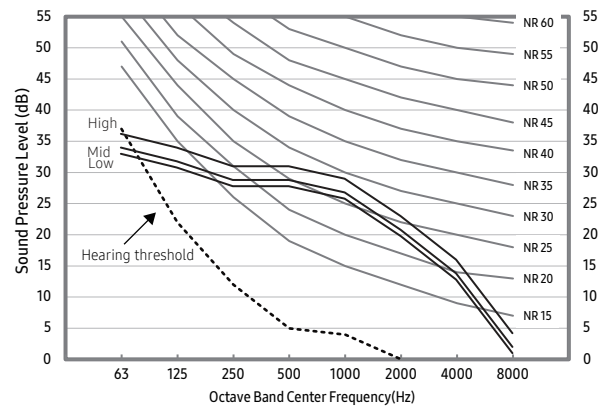

3) AM071FN4DEH***

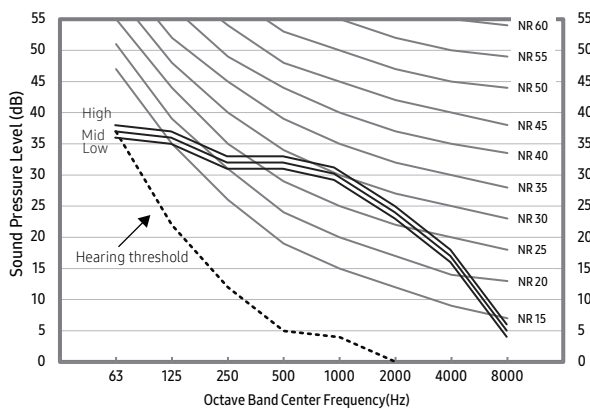

4) AM090FN4DEH***

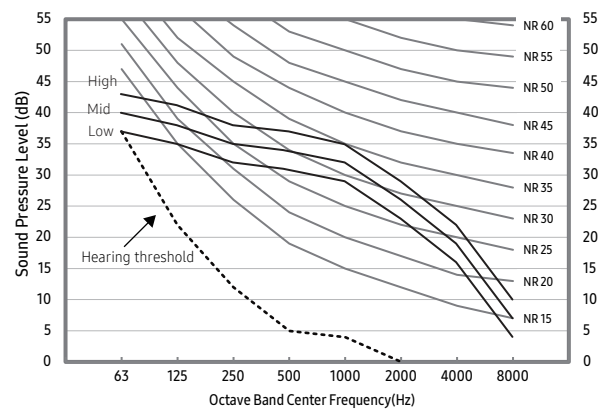

NOTE

- Specifications may be subject to change without prior notice.
- Sound pressure is obtained in an anechoic room.
- Sound pressure level is a relative value, depending on the distance and acoustic environment.
- Sound pressure level may differ depending on operation condition.
- dBA = A weighted sound pressure level
- Reference acoustic pressure 0 dB = 20μPa

7. Sound data

Unit: dB(A)

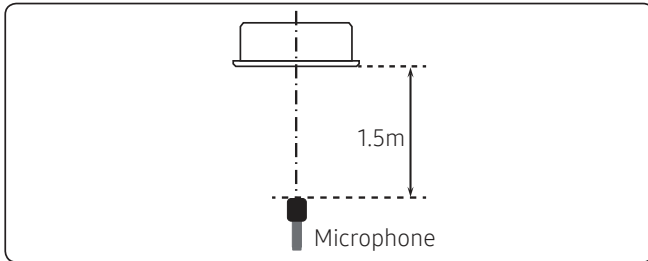

Model	High	Mid	Low
AM112FN4DEH***	40	38	35
AM128FN4DEH***	42	40	35
AM140FN4DEH***	44	41	35

• NR Curve

5) AM112FN4DEH***

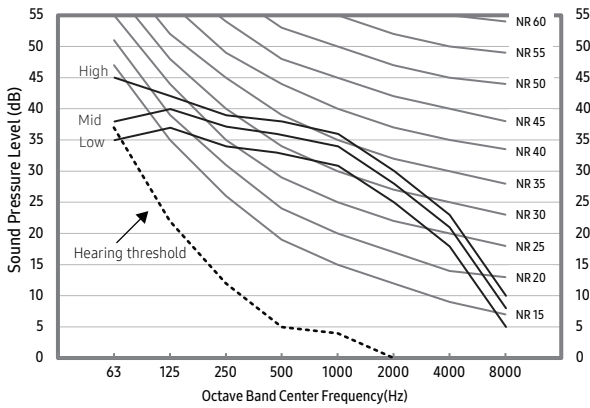

6) AM128FN4DEH***

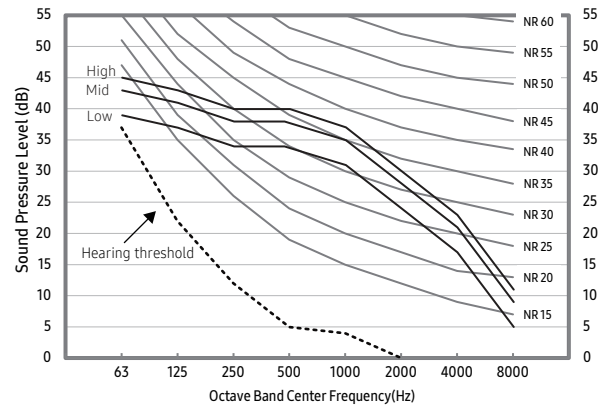

AM140FN4DEH***

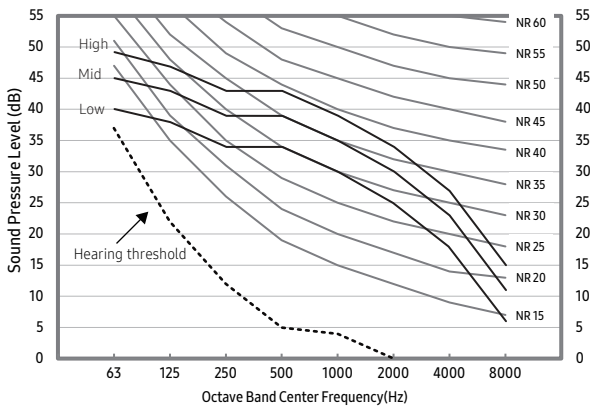

NOTE

- Specifications may be subject to change without prior notice.
- Sound pressure is obtained in an anechoic room.
- Sound pressure level is a relative value, depending on the distance and acoustic environment.
- Sound pressure level may differ depending on operation condition.
- dBA = A weighted sound pressure level
- Reference acoustic pressure 0 dB = 20μPa

7. Sound data

4Way Cassette

Sound Power level

Unit: dB(A)

Model	Power
AM045FN4DEH***	49
AM056FN4DEH***	50
AM071FN4DEH***	54
AM090FN4DEH***	57

1) AM045FN4DEH***

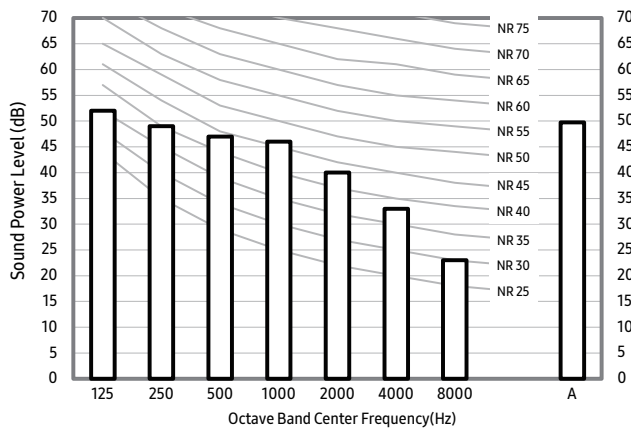

2) AM056FN4DEH***

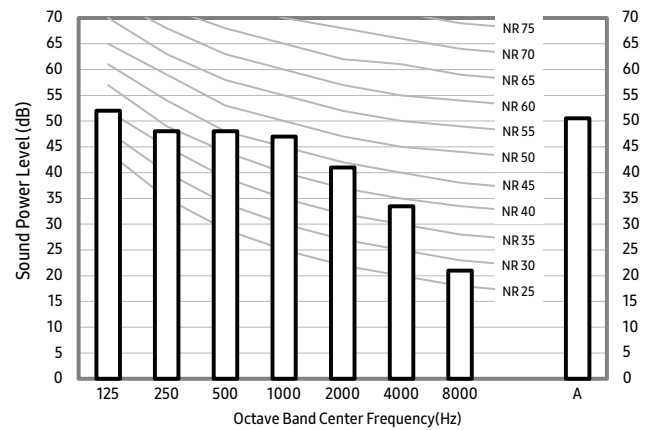

3) AM071FN4DEH***

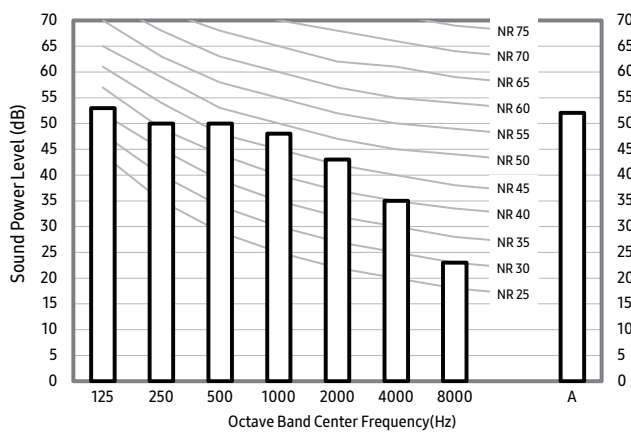

4) AM090FN4DEH***

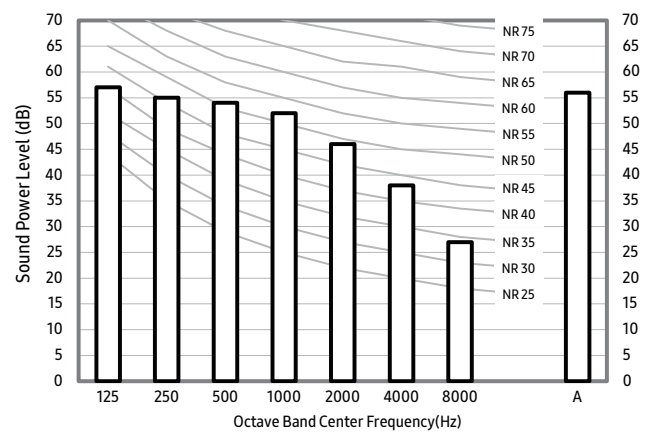

NOTE

- Specifications may be subject to change without prior notice.
- Sound power level is an absolute value that a sound source generates
- dBA = A weighted sound power level
- Reference power : 1pW
- Measured according to ISO 3741

7. Sound data

Unit: dB(A)

Model	Power
AM112FN4DEH***	57
AM128FN4DEH***	58
AM140FN4DEH***	60

5) AM112FN4DEH***

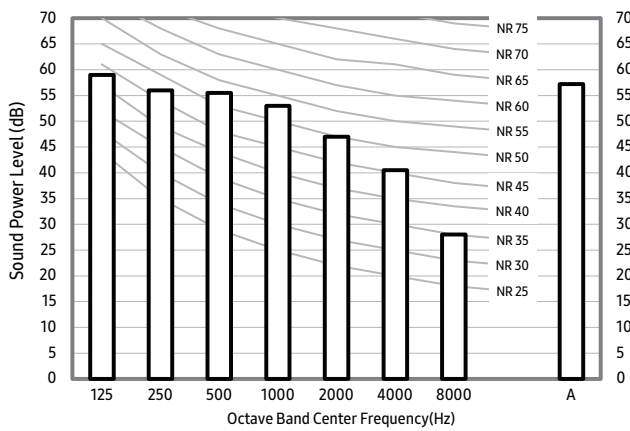

6) AM128FN4DEH***

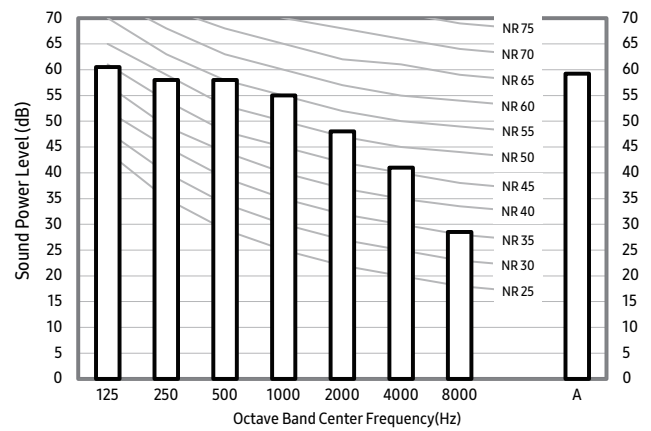

AM140FN4DEH***

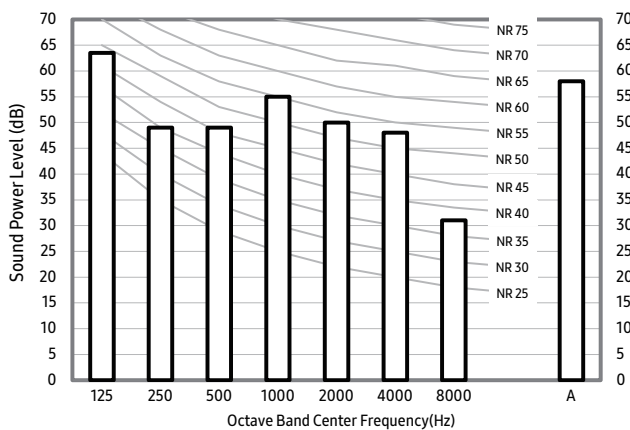

NOTE

- Specifications may be subject to change without prior notice.
- Sound power level is an absolute value that a sound source generates
- dBA = A weighted sound power level
- Reference power : 1pW
- Measured according to ISO 3741

8. Temperature and Air Flow Distribution

4Way Cassette

AM045FN4DEH***

(1) Cooling air velocity distribution Discharge angle: 45°

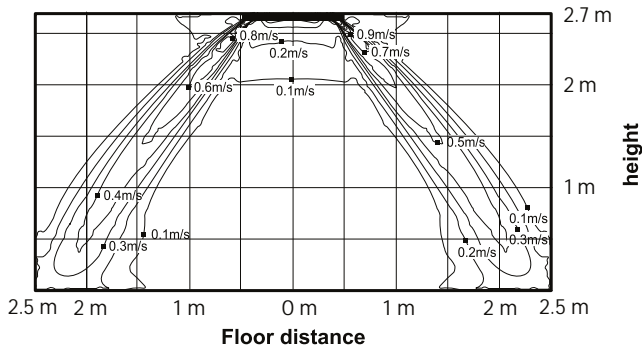

(2) Cooling temperature distribution Discharge angle: 45°



(3) Heating air velocity distribution Discharge angle: 52°

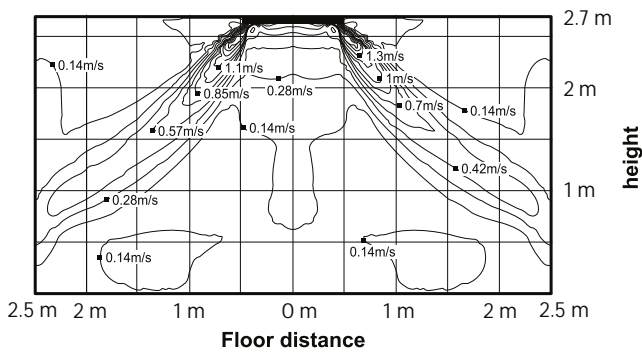

(4) Heating temperature distribution Discharge angle: 52°

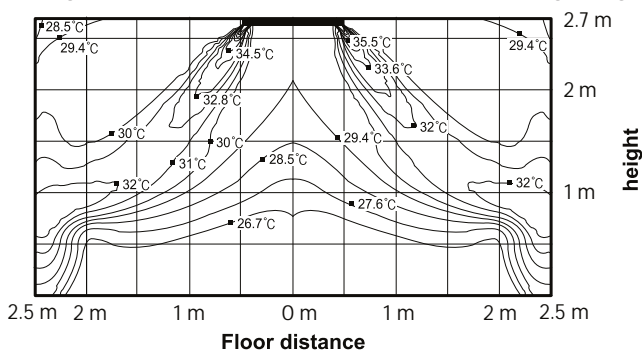

8. Temperature and Air Flow Distribution

AM056FN4DEHX**

(1) Cooling air velocity distribution Discharge angle: 45°

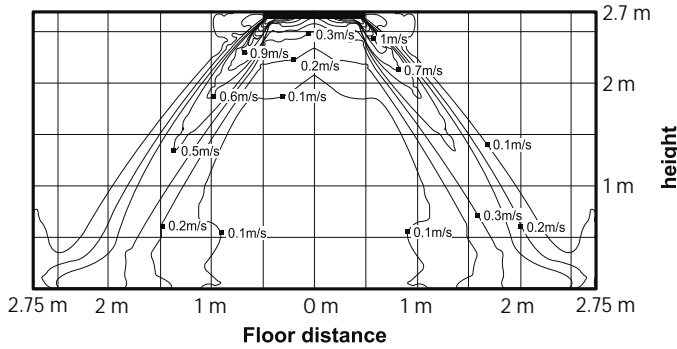

(2) Cooling temperature distribution Discharge angle: 45°

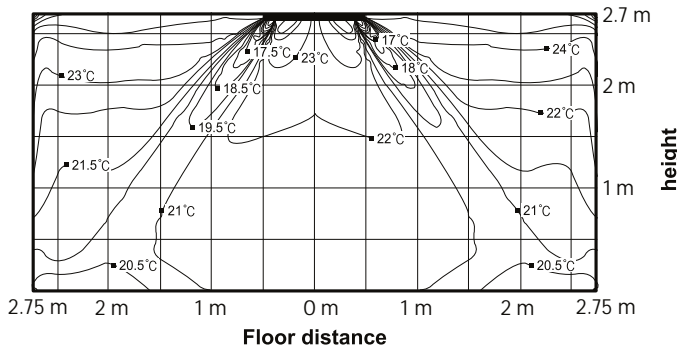

(3) Heating air velocity distribution Discharge angle: 52°

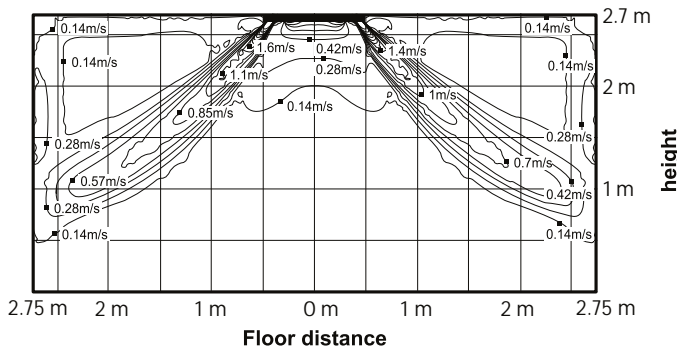

(4) Heating temperature distribution Discharge angle: 52°

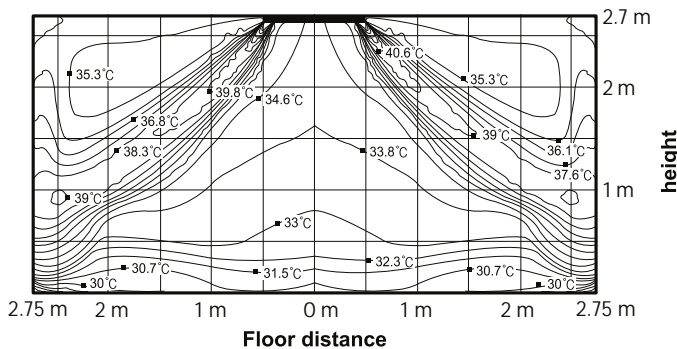

8. Temperature and Air Flow Distribution

AM071FN4DEH***

(1) Cooling air velocity distribution Discharge angle: 45°

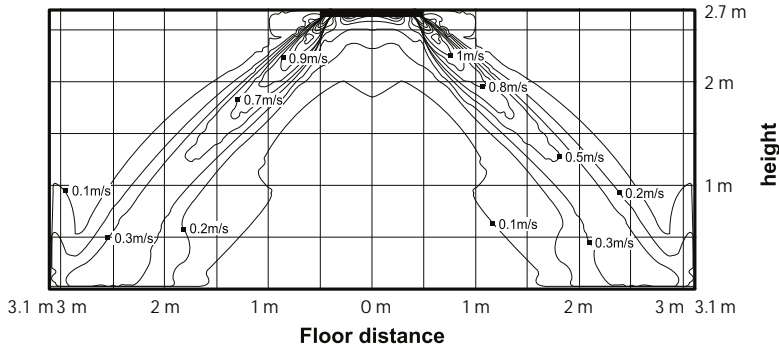

(2) Cooling temperature distribution Discharge angle: 45°

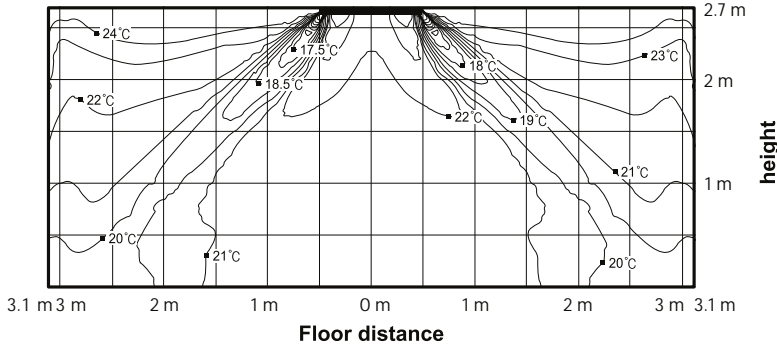

(3) Heating air velocity distribution Discharge angle: 52°

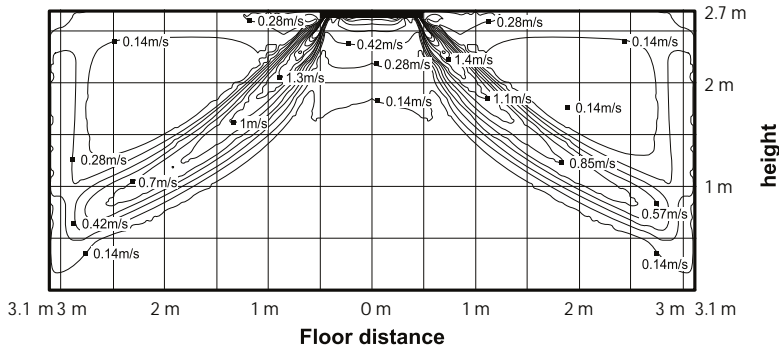

(4) Heating temperature distribution Discharge angle: 52°

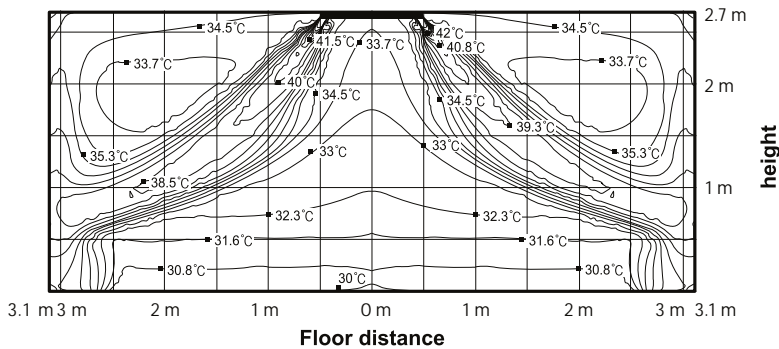

8. Temperature and Air Flow Distribution

AM090FN4DEHXX

(1) Cooling air velocity distribution

Discharge angle: 45°

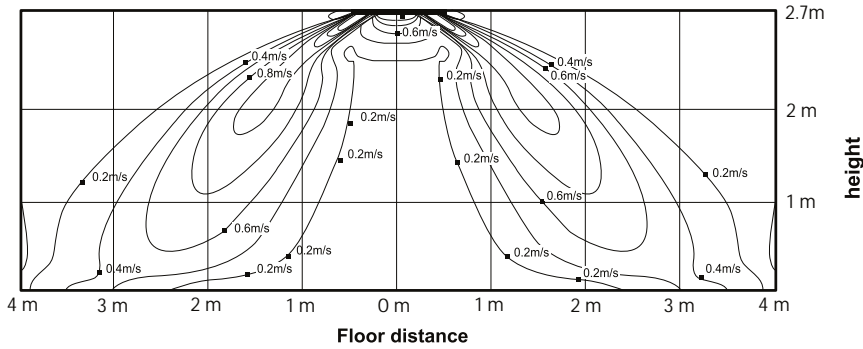

(2) Cooling temperature distribution

Discharge angle: 45°

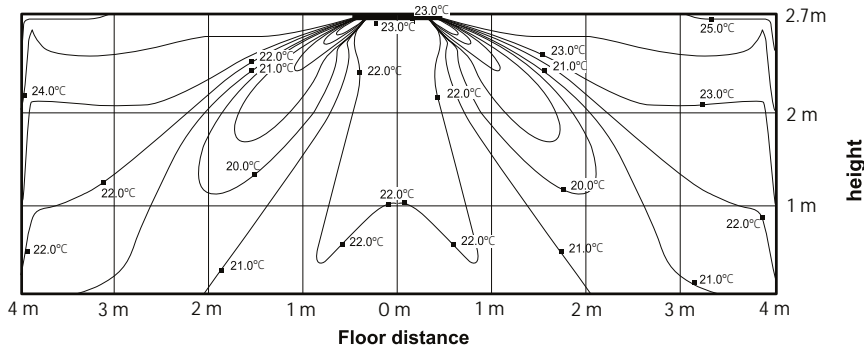

(3) Heating air velocity distribution

Discharge angle: 52°

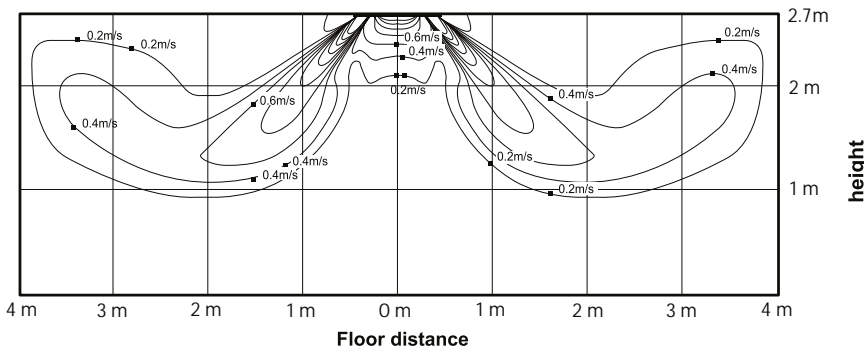

(4) Heating temperature distribution

Discharge angle: 52°

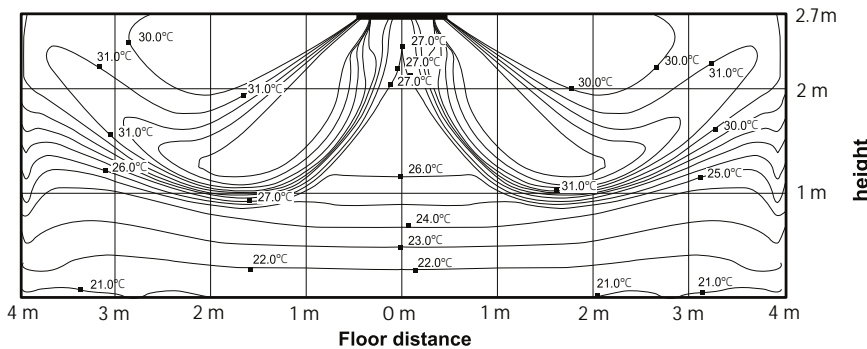

8. Temperature and Air Flow Distribution

AM112FN4DEH***

(1) Cooling air velocity distribution Discharge angle: 45°

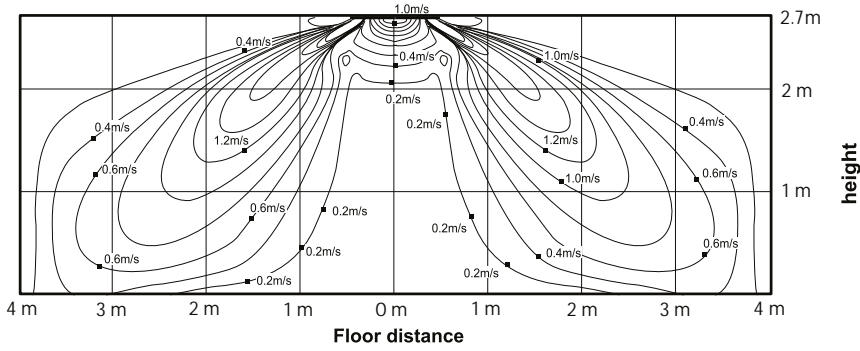

(2) Cooling temperature distribution Discharge angle: 45°

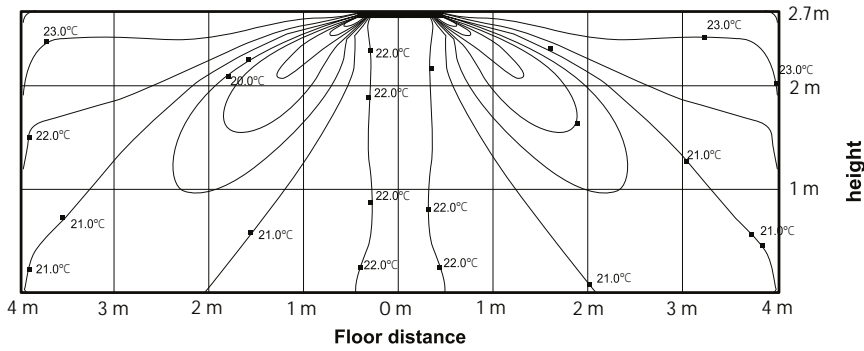

(3) Heating air velocity distribution Discharge angle: 52°

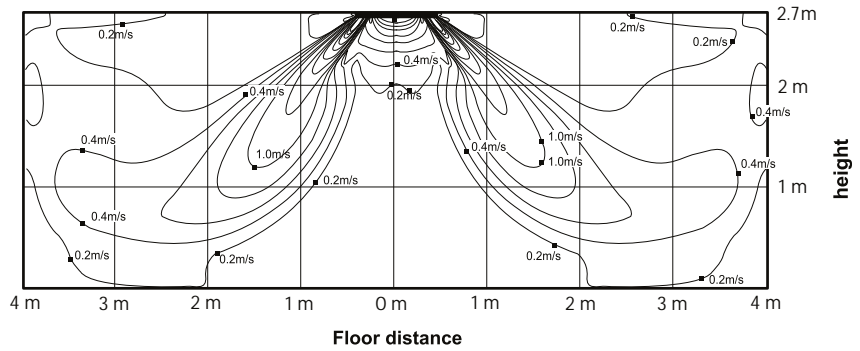

(4) Heating temperature distribution Discharge angle: 52°

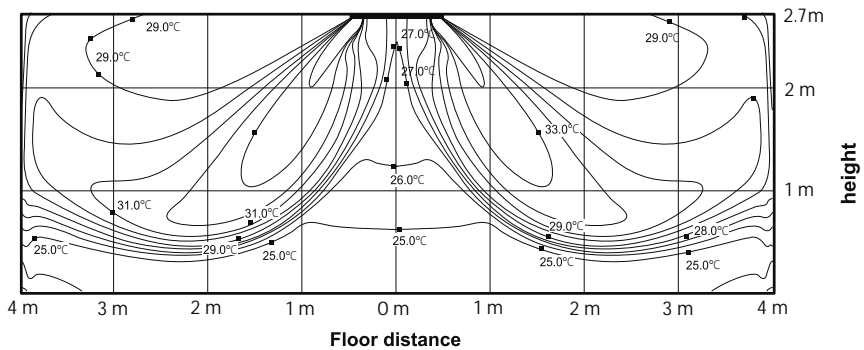

8. Temperature and Air Flow Distribution

AM140FN4DEH***

(1) Cooling air velocity distribution

Discharge angle: 45°

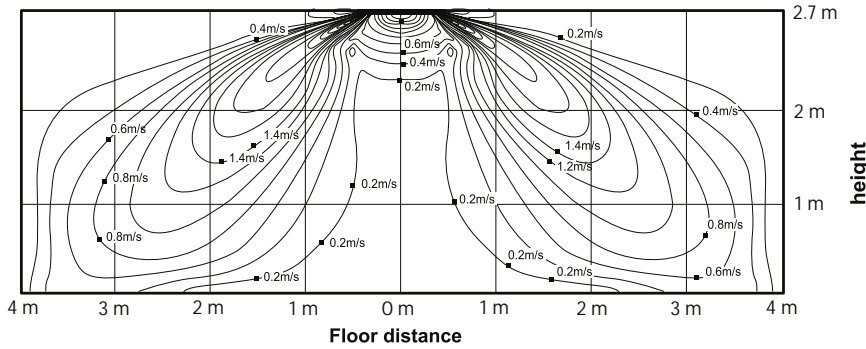

(2) Cooling temperature distribution

Discharge angle: 45°

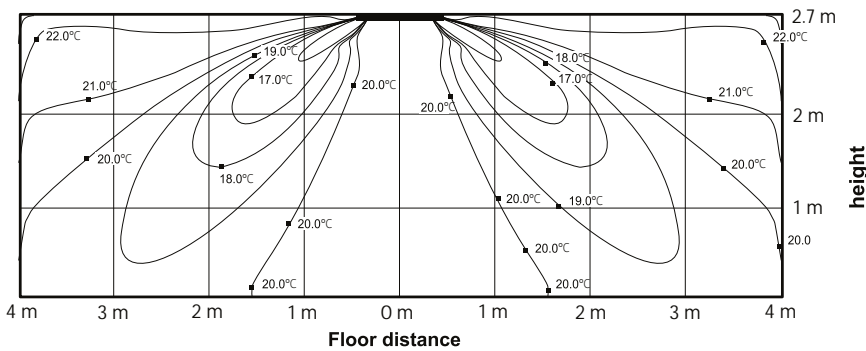

(3) Heating air velocity distribution

Discharge angle: 52°

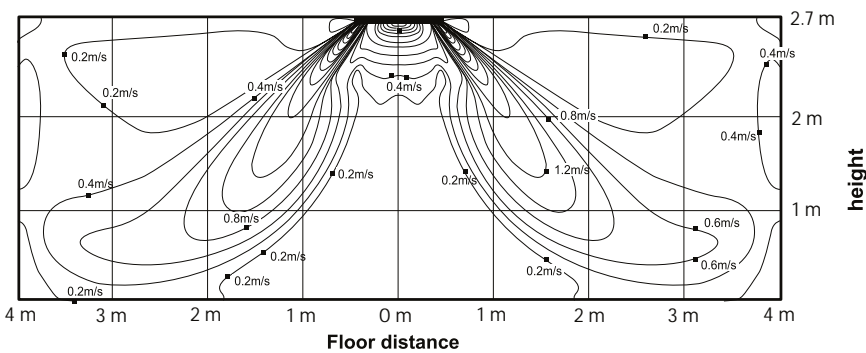

(4) Heating temperature distribution

Discharge angle: 52°

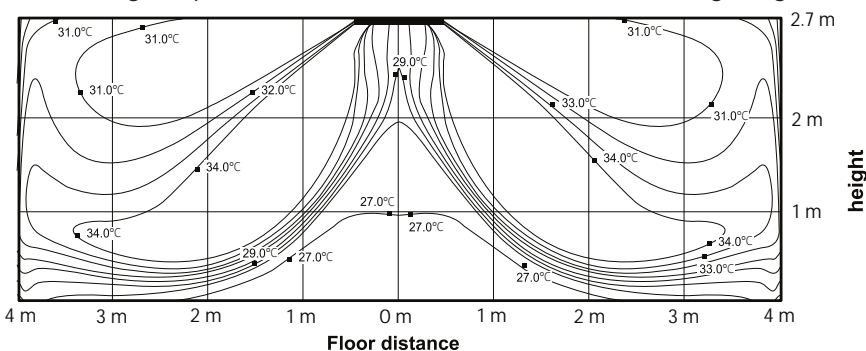

9. Piping Diagram

4Way Cassette

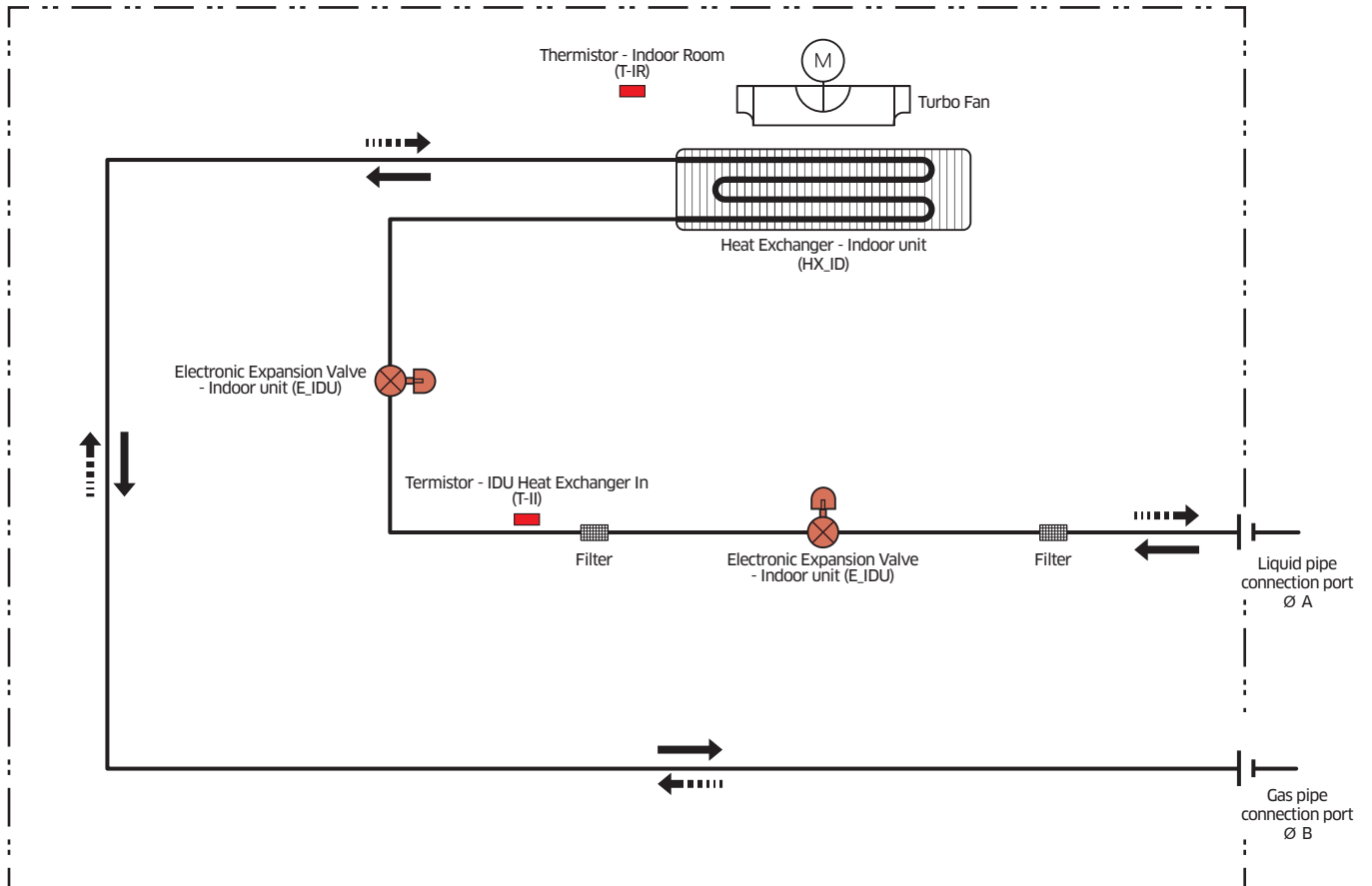

Refrigerant flow	
Cooling	Heating
→	- - - - - →

Model	A	B
AM045FN4DEH***	6.35	12.7
AM056FN4DEH***		
AM071FN4DEH***		
AM090FN4DEH***	9.52	15.88
AM112FN4DEH***		
AM128FN4DEH***		
AM140FN4DEH***		

360 Cassette

- 1 *Specifications*
- 2 *Capacity Table*
- 3 *Dimensional Drawing*
- 4 *Electrical Wiring Diagram*
- 5 *Sound Pressure Level*
- 6 *Sound Power Level*
- 7 *Temperature and air flow distribution*

1 Specifications

360 Cassette

Type			360 Cassette	360 Cassette	360 Cassette	360 Cassette	
Model			AM045KN4DEH/EU	AM056KN4DEH/EU	AM071KN4DEH/EU	AM090KN4DEH/EU	
Power Supply			Ø, #, V, Hz	1,2,220-240,50	1,2,220-240,50	1,2,220-240,50	
Mode			-	HP/HR	HP/HR	HP/HR	
Performance	Capacity (Nominal)	Cooling	kW	4.50	5.60	7.10	9.00
			Btu/h	15,400	19,100	24,200	30,700
		Heating	kW	5.00	6.30	8.00	10.00
			Btu/h	17,100	21,500	27,300	34,100
Power	Power Input (Nominal)	Cooling	W	26.00	30.00	34.00	55.00
		Heating	W	26.00	30.00	34.00	55.00
	Current Input (Nominal)	Cooling	A	0.18	0.21	0.25	0.42
		Heating	A	0.18	0.21	0.25	0.42
Fan	Motor	Type	-	Turbo Fan	Turbo Fan	Turbo Fan	Turbo Fan
		Output x n	w	65 x 1	65 x 1	65 x 1	65 x 1
	Air Flow Rate	H/M/L (UL)	CMM	14.50 / 13.50 / 12.50	16.00 / 14.50 / 13.50	18.00 / 16.00 / 14.00	22.00 / 18.50 / 16.00
			l/s	241.67 / 225.00 / 208.33	266.67 / 241.67 / 225.00	300.00 / 266.67 / 233.33	366.67 / 308.33 / 266.67
	External Pressure	Min/Std/Max	mmAq	-	-	-	-
Pa			-	-	-	-	
Piping Connections	Liquid Pipe	Ø, mm	6.35	6.35	9.52	9.52	
		Ø, inch	1/4"	1/4"	3/8"	3/8"	
	Gas Pipe	Ø, mm	12.70	12.70	15.88	15.88	
		Ø, inch	1/2"	1/2"	5/8"	5/8"	
Drain Pipe	Ø, mm	VP25 (OD 32,ID 25)	VP25 (OD 32,ID 25)	VP25 (OD 32,ID 25)	VP25 (OD 32,ID 25)		
Field Wiring	Power Source Wire	mm ²	1.5 - 2.5	1.5 - 2.5	1.5 - 2.5	1.5 - 2.5	
	Transmission Cable	mm ²	0.75 - 1.50	0.75 - 1.50	0.75 - 1.50	0.75 - 1.50	
Refrigerant	Type	-	R410A	R410A	R410A	R410A	
	Control Method	-	EEV INCLUDED	EEV INCLUDED	EEV INCLUDED	EEV INCLUDED	
Sound	Pressure	High / Mid / Low	dB(A)	33 / 31 / 29	34 / 32 / 29	36 / 33 / 30	40 / 36 / 32
	Power	Cooling		50	51	53	57
Dimension	Net Weight		kg	21.00	21.00	21.00	21.00
	Shipping Weight		kg	25.90	25.90	25.90	25.90
	Net Dimensions (WxHxD)		mm	947 x 281 x 947	947 x 281 x 947	947 x 281 x 947	947 x 281 x 947
	Shipping Dimensions (WxHxD)		mm	990 x 330 x 990	990 x 330 x 990	990 x 330 x 990	990 x 330 x 990
Panel Size	Panel model		-	PC4NUDMAN	PC4NUDMAN	PC4NUDMAN	PC4NUDMAN
	Panel Net Weight		kg	3.60	3.60	3.60	3.60
	Shipping Weight		kg	6.00	6.00	6.00	6.00
	Net Dimensions (WxHxD)		mm	1,000 x 66 x 1,000	1,000 x 66 x 1,000	1,000 x 66 x 1,000	1,000 x 66 x 1,000
	Shipping Dimensions (WxHxD)		mm	1,093 x 85 x 1,083	1,093 x 85 x 1,083	1,093 x 85 x 1,083	1,093 x 85 x 1,083
Additional Accessories	Drain Pump	Drain Pump	- / Model	-	-	-	-
		Max. lifting Height / Displacement	mm/liter/h	-	-	-	-
	Air Filter		-	-	-	-	-

* Specifications may be subject to change without prior notice.

1) Nominal cooling capacities are based on;

- Indoor temperature : 27°C DB, 19°C WB

- Outdoor temperature : 35°C DB, 24°C WB, Equivalent refrigerant piping : 5m, Level differences : 0m

2) Nominal heating capacities are based on;

- Indoor temperature : 20°C DB, 15°C WB

- Outdoor temperature : 7°C DB, 6°C WB, Equivalent refrigerant piping : 5m, Level differences : 0m

3) Sound pressure was acquired in an anechoic room. Thus actual noise level may be different depending on the installation conditions.

4) These products contain R410A which is fluorinated greenhouse gas.

5) Panel type is option. (Ceiling Type/Open Type)

About each detail spec, please refer to Dimensional Drawing pages.

* Heat Exchanger type : Fin & Tube (Fin : Al, Tube : Cu)

1 Specifications

360 Cassette

Type			360 Cassette		360 Cassette		360 Cassette	
Model			AM112KN4DEH/EU		AM128KN4DEH/EU		AM140KN4DEH/EU	
Power Supply			Ø, #, V, Hz	1,2,220-240,50	1,2,220-240,50	1,2,220-240,50	1,2,220-240,50	1,2,220-240,50
Mode			-	HP/HR	HP/HR	HP/HR	HP/HR	HP/HR
Performance	Capacity (Nominal)	Cooling	kW	11.20	12.80	14.00	14.00	14.00
			Btu/h	38,200	43,700	47,800	47,800	47,800
		Heating	kW	12.50	13.80	16.00	16.00	16.00
			Btu/h	42,700	47,100	54,600	54,600	54,600
Power	Power Input (Nominal)	Cooling	W	53.00	77.00	91.00	91.00	91.00
		Heating	W	53.00	77.00	91.00	91.00	91.00
	Current Input (Nominal)	Cooling	A	0.41	0.62	0.75	0.75	0.75
		Heating	A	0.41	0.62	0.75	0.75	0.75
Fan	Motor	Type	-	Turbo Fan	Turbo Fan	Turbo Fan	Turbo Fan	Turbo Fan
		Output x n	w	97 x 1	97 x 1	97 x 1	97 x 1	97 x 1
	Air Flow Rate	H/M/L (UL)	CMM	25.50 / 21.00 / 17.50	29.50 / 24.00 / 19.00	31.50 / 26.50 / 21.00	31.50 / 26.50 / 21.00	31.50 / 26.50 / 21.00
			l/s	425.00 / 350.00 / 291.67	491.67 / 400.00 / 316.67	525.00 / 441.67 / 350.00	525.00 / 441.67 / 350.00	525.00 / 441.67 / 350.00
	External Pressure	Min/Std/Max	mmAq	-	-	-	-	-
Pa			-	-	-	-	-	
Piping Connections	Liquid Pipe		Ø, mm	9.52	9.52	9.52	9.52	
			Ø, inch	3/8"	3/8"	3/8"	3/8"	
	Gas Pipe		Ø, mm	15.88	15.88	15.88	15.88	
			Ø, inch	5/8"	5/8"	5/8"	5/8"	
Drain Pipe		Ø, mm	VP25 (OD 32,ID 25)	VP25 (OD 32,ID 25)	VP25 (OD 32,ID 25)	VP25 (OD 32,ID 25)		
Field Wiring	Power Source Wire		mm ²	1.5 - 2.5	1.5 - 2.5	1.5 - 2.5	1.5 - 2.5	
	Transmission Cable		mm ²	0.75 - 1.50	0.75 - 1.50	0.75 - 1.50	0.75 - 1.50	
Refrigerant	Type		-	R410A	R410A	R410A	R410A	
	Control Method		-	EEV INCLUDED	EEV INCLUDED	EEV INCLUDED	EEV INCLUDED	
Sound	Pressure	High / Mid / Low	dB(A)	40 / 36 / 32	42 / 38 / 33	44 / 40 / 35	44 / 40 / 35	
	Power	Cooling		58	60	61	61	
Dimension	Net Weight		kg	24.00	24.00	24.00	24.00	
	Shipping Weight		kg	29.40	29.40	29.40	29.40	
	Net Dimensions (WxHxD)		mm	947 x 365 x 947	947 x 365 x 947	947 x 365 x 947	947 x 365 x 947	
	Shipping Dimensions (WxHxD)		mm	990 x 414 x 990	990 x 414 x 990	990 x 414 x 990	990 x 414 x 990	
Panel Size	Panel model		-	PC4NUDMAN	PC4NUDMAN	PC4NUDMAN	PC4NUDMAN	
	Panel Net Weight		kg	3.60	3.60	3.60	3.60	
	Shipping Weight		kg	6.00	6.00	6.00	6.00	
	Net Dimensions (WxHxD)		mm	1,000 x 66 x 1,000	1,000 x 66 x 1,000	1,000 x 66 x 1,000	1,000 x 66 x 1,000	
	Shipping Dimensions (WxHxD)		mm	1,093 x 85 x 1,083	1,093 x 85 x 1,083	1,093 x 85 x 1,083	1,093 x 85 x 1,083	
Additional Accessories	Drain Pump	Drain Pump	- / Model	-	-	-	-	
		Max. lifting Height / Displacement	mm/liter/h	-	-	-	-	
	Air Filter			-	-	-	-	

* Specifications may be subject to change without prior notice.

1) Nominal cooling capacities are based on;

- Indoor temperature : 27°C DB, 19°C WB

- Outdoor temperature : 35°C DB, 24°C WB, Equivalent refrigerant piping : 5m, Level differences : 0m

2) Nominal heating capacities are based on;

- Indoor temperature : 20°C DB, 15°C WB

- Outdoor temperature : 7°C DB, 6°C WB, Equivalent refrigerant piping : 5m, Level differences : 0m

3) Sound pressure was acquired in an anechoic room. Thus actual noise level may be different depending on the installation conditions.

4) These products contain R410A which is fluorinated greenhouse gas.

5) Panel type is option. (Ceiling Type/Open Type)

About each detail spec, please refer to Dimensional Drawing pages.

* Heat Exchanger type : Fin & Tube (Fin : Al, Tube : Cu)

2 Capacity table

360 Cassette

Cooling

TC : Total Capacity, SHC : Sensible Heat Capacity

Capacity Index	Outdoor Air Temp. (°C, DB)	Indoor temperature													
		20(°C, DB)		23(°C, DB)		26(°C, DB)		27(°C, DB)		28(°C, DB)		30(°C, DB)		32(°C, DB)	
		14(°C, WB)		16(°C, WB)		18(°C, WB)		19(°C, WB)		20(°C, WB)		22(°C, WB)		24(°C, WB)	
	TC	SHC	TC	SHC	TC	SHC	TC	SHC	TC	SHC	TC	SHC	TC	SHC	
045	10	3.1	2.7	3.7	2.8	4.2	3.0	4.5	3.1	4.7	3.1	5.0	3.1	5.4	2.9
	12	3.1	2.7	3.7	2.8	4.2	3.0	4.5	3.1	4.7	3.1	5.0	3.1	5.4	2.9
	14	3.1	2.7	3.7	2.8	4.2	3.0	4.5	3.1	4.7	3.1	5.0	3.1	5.4	2.9
	16	3.1	2.7	3.7	2.8	4.2	3.0	4.5	3.1	4.7	3.1	5.0	3.1	5.3	2.8
	18	3.1	2.7	3.7	2.8	4.2	3.0	4.5	3.1	4.7	3.1	5.0	3.1	5.3	2.8
	20	3.1	2.7	3.7	2.8	4.2	3.0	4.5	3.1	4.7	3.1	5.0	3.1	5.3	2.8
	21	3.1	2.7	3.7	2.8	4.2	3.0	4.5	3.1	4.7	3.1	5.0	3.1	5.3	2.8
	23	3.1	2.7	3.7	2.8	4.2	3.0	4.5	3.1	4.7	3.1	5.0	3.1	5.3	2.8
	25	3.1	2.7	3.7	2.8	4.2	3.0	4.5	3.1	4.7	3.1	5.0	3.1	5.3	2.8
	27	3.1	2.7	3.7	2.8	4.2	3.0	4.5	3.1	4.7	3.1	5.0	3.1	5.3	2.8
	29	3.1	2.7	3.7	2.8	4.2	3.0	4.5	3.1	4.7	3.1	5.0	3.1	5.3	2.8
	31	3.1	2.7	3.7	2.8	4.2	3.0	4.5	3.1	4.7	3.1	5.0	3.1	5.3	2.8
	33	3.1	2.7	3.7	2.8	4.2	3.0	4.5	3.1	4.7	3.1	5.0	3.1	5.3	2.8
	35	3.1	2.7	3.7	2.8	4.2	3.0	4.5	3.1	4.7	3.1	5.0	3.1	5.3	2.8
	37	3.1	2.7	3.7	2.8	4.2	3.0	4.5	3.1	4.6	3.0	4.9	3.0	5.2	2.7
	39	3.1	2.7	3.7	2.8	4.2	3.0	4.5	3.1	4.6	3.0	4.9	3.0	5.1	2.6
42	3.1	2.7	3.7	2.8	4.2	3.0	4.4	3.1	4.5	3.0	4.8	2.9	5.0	2.5	
44	3.1	2.7	3.7	2.8	4.1	2.9	4.3	3.0	4.4	2.9	4.6	2.8	4.8	2.4	
46	3.1	2.7	3.7	2.8	4.0	2.9	4.2	2.9	4.3	2.8	4.5	2.7	4.7	2.4	
48	3.1	2.7	3.6	2.7	3.9	2.8	4.0	2.8	4.2	2.7	4.3	2.7	4.5	2.3	
056	10	3.9	3.2	4.6	3.5	5.3	3.9	5.6	3.9	5.8	3.9	6.3	3.9	6.7	3.7
	12	3.9	3.2	4.6	3.5	5.3	3.9	5.6	3.9	5.8	3.9	6.3	3.9	6.7	3.7
	14	3.9	3.2	4.6	3.5	5.3	3.9	5.6	3.9	5.8	3.9	6.2	3.8	6.7	3.7
	16	3.9	3.2	4.6	3.5	5.3	3.9	5.6	3.9	5.8	3.9	6.2	3.8	6.6	3.6
	18	3.9	3.2	4.6	3.5	5.3	3.9	5.6	3.9	5.8	3.9	6.2	3.8	6.6	3.6
	20	3.9	3.2	4.6	3.5	5.3	3.9	5.6	3.9	5.8	3.9	6.2	3.8	6.6	3.6
	21	3.9	3.2	4.6	3.5	5.3	3.9	5.6	3.9	5.8	3.9	6.2	3.8	6.6	3.6
	23	3.9	3.2	4.6	3.5	5.3	3.9	5.6	3.9	5.8	3.9	6.2	3.8	6.6	3.6
	25	3.9	3.2	4.6	3.5	5.3	3.9	5.6	3.9	5.8	3.9	6.2	3.8	6.6	3.6
	27	3.9	3.2	4.6	3.5	5.3	3.9	5.6	3.9	5.8	3.9	6.2	3.8	6.6	3.6
	29	3.9	3.2	4.6	3.5	5.3	3.9	5.6	3.9	5.8	3.9	6.2	3.8	6.6	3.6
	31	3.9	3.2	4.6	3.5	5.3	3.9	5.6	3.9	5.8	3.9	6.2	3.8	6.6	3.6
	33	3.9	3.2	4.6	3.5	5.3	3.9	5.6	3.9	5.8	3.9	6.2	3.8	6.6	3.6
	35	3.9	3.2	4.6	3.5	5.3	3.9	5.6	3.9	5.8	3.9	6.2	3.8	6.6	3.6
	37	3.9	3.2	4.6	3.5	5.3	3.9	5.6	3.9	5.8	3.9	6.2	3.8	6.6	3.5
	39	3.9	3.2	4.6	3.5	5.3	3.9	5.6	3.9	5.8	3.9	6.2	3.8	6.6	3.4
42	3.9	3.2	4.6	3.5	5.3	3.9	5.5	3.8	5.7	3.9	6.1	3.7	6.4	3.3	
44	3.9	3.2	4.6	3.5	5.1	3.8	5.3	3.7	5.6	3.7	5.9	3.6	6.2	3.2	
46	3.9	3.2	4.6	3.5	5.0	3.7	5.2	3.6	5.4	3.6	5.7	3.5	6.0	3.1	
48	3.9	3.2	4.5	3.4	5.0	3.6	5.0	3.5	5.3	3.6	5.5	3.4	5.8	3.0	
071	10	4.9	4.0	5.8	4.5	6.7	4.8	7.1	5.0	7.4	5.0	8.0	5.1	8.5	4.8
	12	4.9	4.0	5.8	4.5	6.7	4.8	7.1	5.0	7.4	5.0	7.9	5.0	8.5	4.8
	14	4.9	4.0	5.8	4.5	6.7	4.8	7.1	5.0	7.4	5.0	7.9	5.0	8.5	4.8
	16	4.9	4.0	5.8	4.5	6.7	4.8	7.1	5.0	7.4	5.0	7.9	5.0	8.4	4.8
	18	4.9	4.0	5.8	4.5	6.7	4.8	7.1	5.0	7.4	5.0	7.9	5.0	8.4	4.8
	20	4.9	4.0	5.8	4.5	6.7	4.8	7.1	5.0	7.4	5.0	7.9	5.0	8.4	4.8
	21	4.9	4.0	5.8	4.5	6.7	4.8	7.1	5.0	7.4	5.0	7.9	5.0	8.4	4.8
	23	4.9	4.0	5.8	4.5	6.7	4.8	7.1	5.0	7.4	5.0	7.9	5.0	8.4	4.8
	25	4.9	4.0	5.8	4.5	6.7	4.8	7.1	5.0	7.4	5.0	7.9	5.0	8.4	4.8
	27	4.9	4.0	5.8	4.5	6.7	4.8	7.1	5.0	7.4	5.0	7.9	5.0	8.4	4.8
	29	4.9	4.0	5.8	4.5	6.7	4.8	7.1	5.0	7.4	5.0	7.9	5.0	8.4	4.8
	31	4.9	4.0	5.8	4.5	6.7	4.8	7.1	5.0	7.4	5.0	7.9	5.0	8.4	4.8
	33	4.9	4.0	5.8	4.5	6.7	4.8	7.1	5.0	7.4	5.0	7.9	5.0	8.4	4.8
	35	4.9	4.0	5.8	4.5	6.7	4.8	7.1	5.0	7.4	5.0	7.9	5.0	8.4	4.8
	37	4.9	4.0	5.8	4.5	6.7	4.8	7.1	5.0	7.3	4.9	7.8	4.9	8.2	4.7
	39	4.9	4.0	5.8	4.5	6.7	4.8	7.1	5.0	7.3	4.9	7.7	4.8	8.1	4.6
42	4.9	4.0	5.8	4.5	6.7	4.8	7.0	4.9	7.2	4.8	7.6	4.7	7.9	4.5	
44	4.9	4.0	5.8	4.5	6.5	4.6	6.8	4.8	7.0	4.7	7.3	4.5	7.6	4.3	
46	4.9	4.0	5.7	4.5	6.4	4.6	6.6	4.6	6.8	4.6	7.0	4.4	7.4	4.2	
48	4.8	3.9	5.7	4.4	6.3	4.5	6.4	4.5	6.7	4.5	6.8	4.3	7.2	4.1	

2 Capacity table

360 Cassette

Cooling

TC : Total Capacity, SHC : Sensible Heat Capacity

Capacity Index	Outdoor Air Temp. (°C, DB)	Indoor temperature													
		20(°C, DB)		23(°C, DB)		26(°C, DB)		27(°C, DB)		28(°C, DB)		30(°C, DB)		32(°C, DB)	
		14(°C, WB)		16(°C, WB)		18(°C, WB)		19(°C, WB)		20(°C, WB)		22(°C, WB)		24(°C, WB)	
	TC	SHC	TC	SHC	TC	SHC	TC	SHC	TC	SHC	TC	SHC	TC	SHC	
090	10	6.2	5.2	7.3	5.7	8.4	6.3	9.0	6.3	9.4	6.3	10.1	6.3	10.8	6.3
	12	6.2	5.2	7.3	5.7	8.4	6.3	9.0	6.3	9.4	6.3	10.1	6.3	10.8	6.3
	14	6.2	5.2	7.3	5.7	8.4	6.3	9.0	6.3	9.3	6.3	10.0	6.2	10.7	6.2
	16	6.2	5.2	7.3	5.7	8.4	6.3	9.0	6.3	9.3	6.3	10.0	6.2	10.7	6.2
	18	6.2	5.2	7.3	5.7	8.4	6.3	9.0	6.3	9.3	6.3	10.0	6.2	10.6	6.1
	20	6.2	5.2	7.3	5.7	8.4	6.3	9.0	6.3	9.3	6.3	10.0	6.2	10.6	6.1
	21	6.2	5.2	7.3	5.7	8.4	6.3	9.0	6.3	9.3	6.3	10.0	6.2	10.6	6.1
	23	6.2	5.2	7.3	5.7	8.4	6.3	9.0	6.3	9.3	6.3	10.0	6.2	10.6	6.1
	25	6.2	5.2	7.3	5.7	8.4	6.3	9.0	6.3	9.3	6.3	10.0	6.2	10.6	6.1
	27	6.2	5.2	7.3	5.7	8.4	6.3	9.0	6.3	9.3	6.3	10.0	6.2	10.6	6.1
	29	6.2	5.2	7.3	5.7	8.4	6.3	9.0	6.3	9.3	6.3	10.0	6.2	10.6	6.1
	31	6.2	5.2	7.3	5.7	8.4	6.3	9.0	6.3	9.3	6.3	10.0	6.2	10.6	6.1
	33	6.2	5.2	7.3	5.7	8.4	6.3	9.0	6.3	9.3	6.3	10.0	6.2	10.6	6.1
	35	6.2	5.2	7.3	5.7	8.4	6.3	9.0	6.3	9.3	6.3	10.0	6.2	10.6	6.1
	37	6.2	5.2	7.3	5.7	8.4	6.3	9.0	6.3	9.3	6.3	9.9	6.1	10.4	6.0
	39	6.2	5.2	7.3	5.7	8.4	6.3	9.0	6.4	9.2	6.2	9.7	6.0	10.2	5.9
42	6.2	5.2	7.3	5.7	8.3	6.3	8.9	6.3	9.1	6.1	9.5	5.9	9.9	5.8	
44	6.2	5.2	7.3	5.7	8.1	6.1	8.6	6.1	8.8	6.0	9.2	5.7	9.6	5.6	
46	6.2	5.2	7.2	5.6	8.0	6.0	8.3	5.9	8.6	5.8	8.9	5.5	9.3	5.4	
48	6.1	5.1	7.1	5.6	7.8	5.9	8.1	5.8	8.4	5.7	8.6	5.3	9.0	5.2	
112	10	7.7	6.4	9.1	7.1	10.5	7.8	11.2	7.9	11.6	7.9	12.5	7.9	13.4	7.9
	12	7.7	6.4	9.1	7.1	10.5	7.8	11.2	7.9	11.6	7.9	12.5	7.9	13.4	7.9
	14	7.7	6.4	9.1	7.1	10.5	7.8	11.2	7.9	11.6	7.9	12.5	7.9	13.3	7.8
	16	7.7	6.4	9.1	7.1	10.5	7.8	11.2	7.9	11.6	7.9	12.5	7.9	13.3	7.8
	18	7.7	6.4	9.1	7.1	10.5	7.8	11.2	7.9	11.6	7.9	12.4	7.9	13.2	7.7
	20	7.7	6.4	9.1	7.1	10.5	7.8	11.2	7.9	11.6	7.9	12.4	7.9	13.2	7.7
	21	7.7	6.4	9.1	7.1	10.5	7.8	11.2	7.9	11.6	7.9	12.4	7.9	13.2	7.7
	23	7.7	6.4	9.1	7.1	10.5	7.8	11.2	7.9	11.6	7.9	12.4	7.9	13.2	7.7
	25	7.7	6.4	9.1	7.1	10.5	7.8	11.2	7.9	11.6	7.9	12.4	7.9	13.2	7.7
	27	7.7	6.4	9.1	7.1	10.5	7.8	11.2	7.9	11.6	7.9	12.4	7.9	13.2	7.7
	29	7.7	6.4	9.1	7.1	10.5	7.8	11.2	7.9	11.6	7.9	12.4	7.9	13.2	7.7
	31	7.7	6.4	9.1	7.1	10.5	7.8	11.2	7.9	11.6	7.9	12.4	7.9	13.2	7.7
	33	7.7	6.3	9.1	7.0	10.5	7.8	11.2	7.9	11.6	7.9	12.4	7.9	13.2	7.7
	35	7.7	6.3	9.1	7.0	10.5	7.8	11.2	7.9	11.6	7.9	12.4	7.9	13.2	7.7
	37	7.7	6.3	9.1	7.0	10.5	7.8	11.2	7.9	11.6	7.9	12.3	7.8	13.0	7.6
	39	7.7	6.3	9.1	7.0	10.5	7.8	11.2	8.0	11.5	7.8	12.1	7.7	12.7	7.5
42	7.7	6.3	9.1	7.0	10.4	7.7	11.1	7.9	11.4	7.7	11.9	7.6	12.4	7.3	
44	7.7	6.3	9.1	7.0	10.1	7.5	10.7	7.6	11.0	7.5	11.4	7.3	12.0	7.1	
46	7.7	6.3	9.0	6.9	10.0	7.4	10.4	7.4	10.7	7.3	11.0	7.0	11.6	6.9	
48	7.6	6.2	8.9	6.8	9.8	7.3	10.1	7.2	10.5	7.1	10.7	6.8	11.2	6.6	
128	10	8.8	7.3	10.4	8.1	12.0	9.0	12.8	9.1	13.3	9.1	14.3	9.1	15.4	9.1
	12	8.8	7.3	10.4	8.1	12.0	9.0	12.8	9.1	13.3	9.1	14.3	9.1	15.3	9.0
	14	8.8	7.3	10.4	8.1	12.0	9.0	12.8	9.1	13.3	9.1	14.3	9.1	15.3	9.0
	16	8.8	7.3	10.4	8.1	12.0	9.0	12.8	9.1	13.3	9.1	14.2	9.0	15.2	8.9
	18	8.8	7.3	10.4	8.1	12.0	9.0	12.8	9.1	13.3	9.1	14.2	9.0	15.1	8.8
	20	8.8	7.3	10.4	8.1	12.0	9.0	12.8	9.1	13.3	9.1	14.2	9.0	15.1	8.8
	21	8.8	7.3	10.4	8.1	12.0	9.0	12.8	9.1	13.3	9.1	14.2	9.0	15.1	8.8
	23	8.8	7.3	10.4	8.1	12.0	9.0	12.8	9.1	13.3	9.1	14.2	9.0	15.1	8.8
	25	8.8	7.3	10.4	8.1	12.0	9.0	12.8	9.1	13.3	9.1	14.2	9.0	15.1	8.8
	27	8.8	7.3	10.4	8.1	12.0	9.0	12.8	9.1	13.3	9.1	14.2	9.0	15.1	8.8
	29	8.8	7.3	10.4	8.1	12.0	9.0	12.8	9.1	13.3	9.1	14.2	9.0	15.1	8.8
	31	8.8	7.3	10.4	8.1	12.0	9.0	12.8	9.1	13.3	9.1	14.2	9.0	15.1	8.8
	33	8.8	7.3	10.4	8.1	12.0	9.0	12.8	9.1	13.3	9.1	14.2	9.0	15.1	8.8
	35	8.8	7.3	10.4	8.1	12.0	9.0	12.8	9.1	13.3	9.1	14.2	9.0	15.1	8.8
	37	8.8	7.3	10.4	8.1	12.0	9.0	12.8	9.1	13.2	9.0	14.0	8.9	14.9	8.7
	39	8.8	7.3	10.4	8.1	12.0	9.0	12.8	9.2	13.1	8.9	13.8	8.8	14.5	8.6
42	8.8	7.3	10.4	8.1	11.9	8.9	12.6	9.1	12.9	8.8	13.6	8.6	14.1	8.4	
44	8.8	7.3	10.4	8.1	11.6	8.7	12.2	8.8	12.6	8.5	13.0	8.3	13.6	8.1	
46	8.8	7.3	10.3	8.0	11.4	8.6	11.8	8.5	12.2	8.3	12.6	8.0	13.3	7.9	
48	8.7	7.2	10.2	7.9	11.2	8.4	11.5	8.3	12.0	8.1	12.2	7.8	12.8	7.6	

2 Capacity table

360 Cassette

Cooling

TC : Total Capacity, SHC : Sensible Heat Capacity

Capacity Index	Outdoor Air Temp. (°C, DB)	Indoor temperature													
		20(°C, DB)		23(°C, DB)		26(°C, DB)		27(°C, DB)		28(°C, DB)		30(°C, DB)		32(°C, DB)	
		14(°C, WB)		16(°C, WB)		18(°C, WB)		19(°C, WB)		20(°C, WB)		22(°C, WB)		24(°C, WB)	
	TC	SHC	TC	SHC	TC	SHC	TC	SHC	TC	SHC	TC	SHC	TC	SHC	
140	10	9.7	7.7	11.4	8.5	13.1	9.4	14.0	9.6	14.6	9.6	15.7	9.5	16.8	9.7
	12	9.7	7.7	11.4	8.5	13.1	9.4	14.0	9.6	14.5	9.6	15.6	9.6	16.7	9.6
	14	9.7	7.7	11.4	8.5	13.1	9.4	14.0	9.6	14.5	9.6	15.6	9.6	16.7	9.6
	16	9.7	7.7	11.4	8.5	13.1	9.4	14.0	9.6	14.5	9.6	15.6	9.6	16.6	9.5
	18	9.7	7.7	11.4	8.5	13.1	9.4	14.0	9.6	14.5	9.6	15.5	9.5	16.6	9.5
	20	9.7	7.7	11.4	8.5	13.1	9.4	14.0	9.6	14.5	9.6	15.5	9.5	16.5	9.4
	21	9.7	7.7	11.4	8.5	13.1	9.4	14.0	9.6	14.5	9.6	15.5	9.5	16.5	9.4
	23	9.7	7.7	11.4	8.5	13.1	9.4	14.0	9.6	14.5	9.6	15.5	9.5	16.5	9.4
	25	9.7	7.7	11.4	8.5	13.1	9.4	14.0	9.6	14.5	9.6	15.5	9.5	16.5	9.4
	27	9.7	7.7	11.4	8.5	13.1	9.4	14.0	9.6	14.5	9.6	15.5	9.5	16.5	9.4
	29	9.7	7.7	11.4	8.5	13.1	9.4	14.0	9.6	14.5	9.6	15.5	9.5	16.5	9.4
	31	9.7	7.7	11.4	8.5	13.1	9.4	14.0	9.6	14.5	9.6	15.5	9.5	16.5	9.4
	33	9.7	7.7	11.4	8.5	13.1	9.4	14.0	9.6	14.5	9.6	15.5	9.5	16.5	9.4
	35	9.7	7.7	11.4	8.5	13.1	9.4	14.0	9.6	14.5	9.6	15.5	9.5	16.5	9.4
	37	9.7	7.7	11.4	8.5	13.1	9.4	14.0	9.6	14.5	9.6	15.4	9.4	16.3	9.2
	39	9.7	7.7	11.4	8.5	13.1	9.4	14.0	9.6	14.4	9.4	15.1	9.3	15.9	9.0
	42	9.7	7.7	11.4	8.5	13.0	9.3	13.8	9.5	14.2	9.3	14.8	9.1	15.5	8.8
44	9.7	7.7	11.4	8.5	12.7	9.1	13.4	9.2	13.8	9.0	14.2	8.8	15.0	8.5	
46	9.7	7.7	11.3	8.4	12.4	8.9	12.9	8.9	13.4	8.8	13.8	8.5	14.6	8.2	
48	9.6	7.6	11.1	8.3	12.2	8.8	12.6	8.6	13.1	8.6	13.4	8.2	14.1	8.0	

2 Capacity table

360 Cassette

Heating

TC : Total Capacity

Capacity Index	Outdoor Air Temp. (°C)		Indoor temperature (°C,DB)				
			16(°C,DB)	18(°C,DB)	20(°C,DB)	22(°C,DB)	24(°C,DB)
	DB	WB	TC kW	TC kW	TC kW	TC kW	TC kW
045	-19.8	-20.0	3.1	3.1	2.9	2.9	2.9
	-18.8	-19.0	3.1	3.1	3.0	2.9	2.9
	-16.7	-17.0	3.2	3.2	3.1	3.0	3.0
	-14.7	-15.0	3.3	3.3	3.2	3.1	3.0
	-12.6	-13.0	3.5	3.4	3.4	3.3	3.2
	-10.5	-11.0	3.7	3.6	3.6	3.5	3.4
	-9.5	-10.0	3.7	3.6	3.6	3.5	3.5
	-8.5	-9.1	3.8	3.7	3.7	3.6	3.6
	-7.0	-7.6	3.9	3.8	3.8	3.7	3.6
	-5.0	-5.6	4.1	4.0	4.0	3.9	3.7
	-3.0	-3.7	4.3	4.2	4.2	4.0	3.9
	0.0	-0.7	4.5	4.4	4.4	4.2	4.0
	3.0	2.2	4.7	4.7	4.6	4.4	4.2
	5.0	4.1	4.9	4.9	4.8	4.5	4.2
	7.0	6.0	5.1	5.1	5.0	4.6	4.2
9.0	7.9	5.3	5.2	5.0	4.6	4.2	
056	-19.8	-20.0	3.9	3.8	3.8	3.7	3.7
	-18.8	-19.0	3.9	3.9	3.8	3.7	3.7
	-16.7	-17.0	4.0	4.0	3.9	3.8	3.8
	-14.7	-15.0	4.2	4.1	4.0	3.9	3.8
	-12.6	-13.0	4.4	4.3	4.2	4.1	4.0
	-10.5	-11.0	4.6	4.5	4.4	4.4	4.3
	-9.5	-10.0	4.7	4.6	4.6	4.5	4.4
	-8.5	-9.1	4.8	4.7	4.7	4.6	4.5
	-7.0	-7.6	4.9	4.8	4.8	4.7	4.5
	-5.0	-5.6	5.2	5.1	5.0	4.9	4.7
	-3.0	-3.7	5.4	5.3	5.3	5.1	4.9
	0.0	-0.7	5.7	5.6	5.5	5.3	5.0
	3.0	2.2	5.9	5.9	5.8	5.6	5.3
	5.0	4.1	6.2	6.1	6.0	5.7	5.3
	7.0	6.0	6.5	6.4	6.3	5.8	5.3
9.0	7.9	6.7	6.5	6.3	5.8	5.3	
071	-19.8	-20.0	4.9	4.9	4.8	4.7	4.7
	-18.8	-19.0	5.0	4.9	4.8	4.7	4.7
	-16.7	-17.0	5.1	5.0	4.9	4.8	4.8
	-14.7	-15.0	5.3	5.2	5.1	4.9	4.8
	-12.6	-13.0	5.5	5.4	5.3	5.2	5.1
	-10.5	-11.0	5.8	5.7	5.6	5.5	5.5
	-9.5	-10.0	6.0	5.9	5.8	5.7	5.6
	-8.5	-9.1	6.1	6.0	5.9	5.8	5.7
	-7.0	-7.6	6.2	6.1	6.0	5.9	5.8
	-5.0	-5.6	6.5	6.5	6.4	6.2	6.0
	-3.0	-3.7	6.9	6.8	6.7	6.4	6.2
	0.0	-0.7	7.2	7.1	7.0	6.7	6.4
	3.0	2.2	7.6	7.5	7.3	7.1	6.8
	5.0	4.1	7.9	7.8	7.7	7.2	6.8
	7.0	6.0	8.2	8.1	8.0	7.4	6.8
9.0	7.9	8.5	8.2	8.0	7.4	6.8	
11.0	9.8	8.7	8.4	8.0	7.4	6.8	
13.0	11.8	9.0	8.5	8.0	7.4	6.8	
15.0	13.7	9.2	8.6	8.0	7.4	6.8	

2 Capacity table

360 Cassette

Heating

TC : Total Capacity

Capacity Index	Outdoor Air Temp. (°C)		Indoor temperature (°C,DB)				
			16(°C,DB)	18(°C,DB)	20(°C,DB)	22(°C,DB)	24(°C,DB)
	DB	WB	TC	TC	TC	TC	TC
090	-19.8	-20.0	6.0	6.0	5.9	5.8	5.8
	-18.8	-19.0	6.1	6.1	6.0	5.9	5.8
	-16.7	-17.0	6.4	6.3	6.1	6.0	5.9
	-14.7	-15.0	6.7	6.5	6.3	6.2	6.1
	-12.6	-13.0	6.9	6.8	6.6	6.5	6.4
	-10.5	-11.0	7.2	7.1	7.0	6.9	6.9
	-9.5	-10.0	7.4	7.3	7.2	7.1	7.0
	-8.5	-9.1	7.6	7.5	7.4	7.2	7.1
	-7.0	-7.6	7.8	7.7	7.6	7.4	7.2
	-5.0	-5.6	8.2	8.1	8.0	7.7	7.5
	-3.0	-3.7	8.6	8.5	8.4	8.1	7.7
	0.0	-0.7	9.0	8.9	8.8	8.4	8.0
	3.0	2.2	9.4	9.3	9.2	8.8	8.4
	5.0	4.1	9.9	9.7	9.6	9.0	8.4
	7.0	6.0	10.3	10.1	10.0	9.2	8.4
9.0	7.9	10.6	10.3	10.0	9.2	8.4	
11.0	9.8	10.9	10.5	10.0	9.2	8.4	
13.0	11.8	11.2	10.6	10.0	9.2	8.4	
15.0	13.7	11.6	10.8	10.0	9.2	8.4	
112	-19.8	-20.0	7.4	7.4	7.3	7.3	7.3
	-18.8	-19.0	7.6	7.6	7.4	7.4	7.3
	-16.7	-17.0	8.1	7.8	7.6	7.5	7.4
	-14.7	-15.0	8.4	8.2	8.0	7.8	7.6
	-12.6	-13.0	8.7	8.5	8.3	8.1	8.0
	-10.5	-11.0	9.1	8.9	8.8	8.7	8.6
	-9.5	-10.0	9.3	9.1	9.0	8.9	8.8
	-8.5	-9.1	9.5	9.3	9.2	9.0	8.9
	-7.0	-7.6	9.7	9.6	9.4	9.2	9.0
	-5.0	-5.6	10.2	10.1	9.9	9.6	9.3
	-3.0	-3.7	10.7	10.6	10.5	10.1	9.7
	0.0	-0.7	11.3	11.1	11.1	10.5	10.0
	3.0	2.2	11.8	11.6	11.5	11.0	10.6
	5.0	4.1	12.3	12.2	12.0	11.3	10.6
	7.0	6.0	12.9	12.7	12.5	11.5	10.6
9.0	7.9	13.3	12.9	12.5	11.5	10.6	
11.0	9.8	13.7	13.1	12.5	11.5	10.6	
13.0	11.8	14.0	13.3	12.5	11.5	10.6	
15.0	13.7	14.4	13.5	12.5	11.5	10.6	
128	-19.8	-20.0	8.1	8.1	8.0	8.0	8.0
	-18.8	-19.0	8.3	8.3	8.2	8.1	8.0
	-16.7	-17.0	8.8	8.6	8.4	8.3	8.1
	-14.7	-15.0	9.3	9.1	8.8	8.6	8.3
	-12.6	-13.0	9.6	9.4	9.2	9.0	8.8
	-10.5	-11.0	10.0	9.9	9.8	9.6	9.4
	-9.5	-10.0	10.2	10.1	10.0	9.8	9.7
	-8.5	-9.1	10.4	10.3	10.2	10.0	9.8
	-7.0	-7.6	10.7	10.6	10.4	10.2	10.0
	-5.0	-5.6	11.3	11.1	11.0	10.7	10.3
	-3.0	-3.7	11.9	11.7	11.5	11.1	10.7
	0.0	-0.7	12.4	12.3	12.1	11.6	11.0
	3.0	2.2	13.0	12.9	12.7	12.2	11.7
	5.0	4.1	13.6	13.4	13.2	12.4	11.7
	7.0	6.0	14.2	14.0	13.8	12.7	11.7
9.0	7.9	14.6	14.2	13.8	12.7	11.7	
11.0	9.8	15.1	14.4	13.8	12.7	11.7	
13.0	11.8	15.5	14.7	13.8	12.7	11.7	
15.0	13.7	15.9	14.9	13.8	12.7	11.7	

2 Capacity table

360 Cassette

Heating

TC : Total Capacity

Capacity Index	Outdoor Air Temp. (°C)		Indoor temperature (°C,DB)				
			16(°C,DB)	18(°C,DB)	20(°C,DB)	22(°C,DB)	24(°C,DB)
	DB	WB	TC	TC	TC	TC	TC
140	-19.8	-20.0	9.5	9.5	9.4	9.4	9.3
	-18.8	-19.0	9.7	9.7	9.5	9.5	9.3
	-16.7	-17.0	10.2	10.0	9.7	9.6	9.4
	-14.7	-15.0	10.8	10.5	10.2	9.9	9.6
	-12.6	-13.0	11.1	10.9	10.7	10.4	10.1
	-10.5	-11.0	11.6	11.5	11.3	11.1	10.9
	-9.5	-10.0	11.8	11.7	11.5	11.4	11.2
	-8.5	-9.1	12.1	11.9	11.8	11.6	11.3
	-7.0	-7.6	12.4	12.2	12.1	11.8	11.5
	-5.0	-5.6	13.1	12.9	12.7	12.3	12.0
	-3.0	-3.7	13.8	13.6	13.4	12.9	12.4
	0.0	-0.7	14.4	14.2	14.0	13.4	12.8
	3.0	2.2	15.1	14.9	14.7	14.1	13.5
	5.0	4.1	15.8	15.6	15.3	14.4	13.5
	7.0	6.0	16.5	16.2	16.0	14.8	13.5
	9.0	7.9	17.0	16.5	16.0	14.8	13.5
11.0	9.8	17.5	16.7	16.0	14.8	13.5	
13.0	11.8	18.0	17.0	16.0	14.8	13.5	
15.0	13.7	18.5	17.2	16.0	14.8	13.5	

3 Dimensional drawing

360 Cassette

AM045KN4DEH/EU, AM056KN4DEH/EU, AM071KN4DEH/EU, AM090KN4DEH/EU

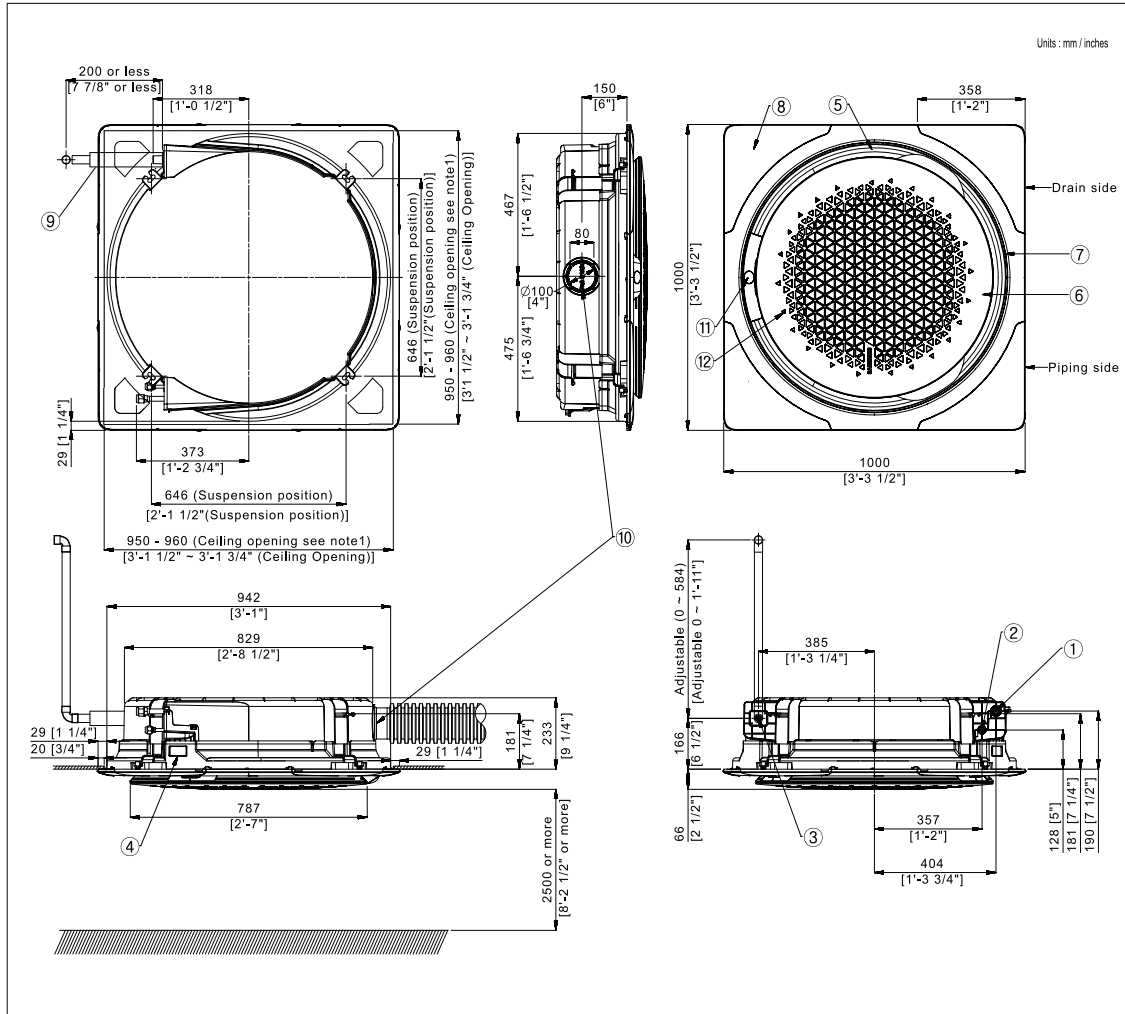

Note

1. Make sure the spacing between the ceiling and the cassette is no more than 10mm[3/8"].
2. When the conditions exceed 30°C[86°F] and RH 80% in the ceiling or fresh air is inducted into the ceiling, and additional insulation is required (polyethylene foam, thickness 10mm[3/8"] or more)
3. Ceiling type panel model code : PC4NUDMAN

Table of descriptions

1	Refrigerant gas pipe	7	Suction rim for Booster fan
2	Refrigerant liquid pipe	8	Decoration cover
3	Condensate drain	9	Drain hose
4	Power & Comm. wiring conduits	10	Fresh air intake knock out hole
5	Air discharge opening	11	Display window
6	Air suction grille	12	Infrared grille

3 Dimensional drawing

360 Cassette

AM112KN4DEH/EU, AM128KN4DEH/EU, AM140KN4DEH/EU

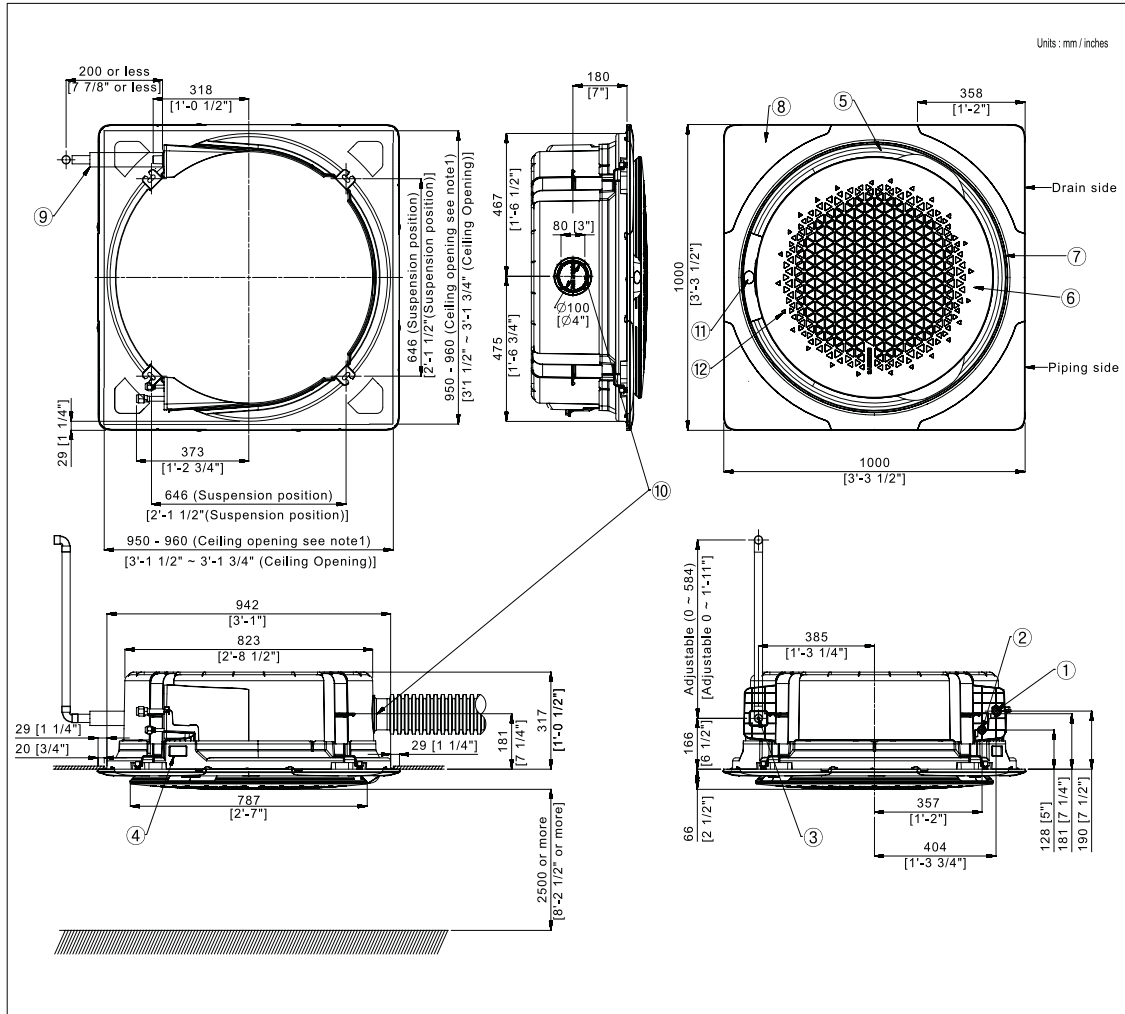

Note

1. Make sure the spacing between the ceiling and the cassette is no more than 29mm[1 1/4"]. Max ceiling opening : 960mm[3'-1 3/4"]
2. When the conditions exceed 30°C and RH 80% in the ceiling or fresh air is inducted into the ceiling, and additional insulation is required (polyethylene foam, thickness 10mm[3/8"] or more)
3. Ceiling type panel model code : PC4NUDMAN

Table of descriptions

1	Refrigerant gas pipe	7	Suction rim for Booster fan
2	Refrigerant liquid pipe	8	Corner decoration cover
3	Condensate drain	9	Drain hose
4	Power & Comm. wiring conduits	10	Fresh air intake knock out hole
5	Air discharge opening	11	Display window
6	Air suction grille	12	Infrared receiver

3 Dimensional drawing

360 Cassette

AM045KN4DEH/EU, AM056KN4DEH/EU, AM071KN4DEH/EU, AM090KN4DEH/EU

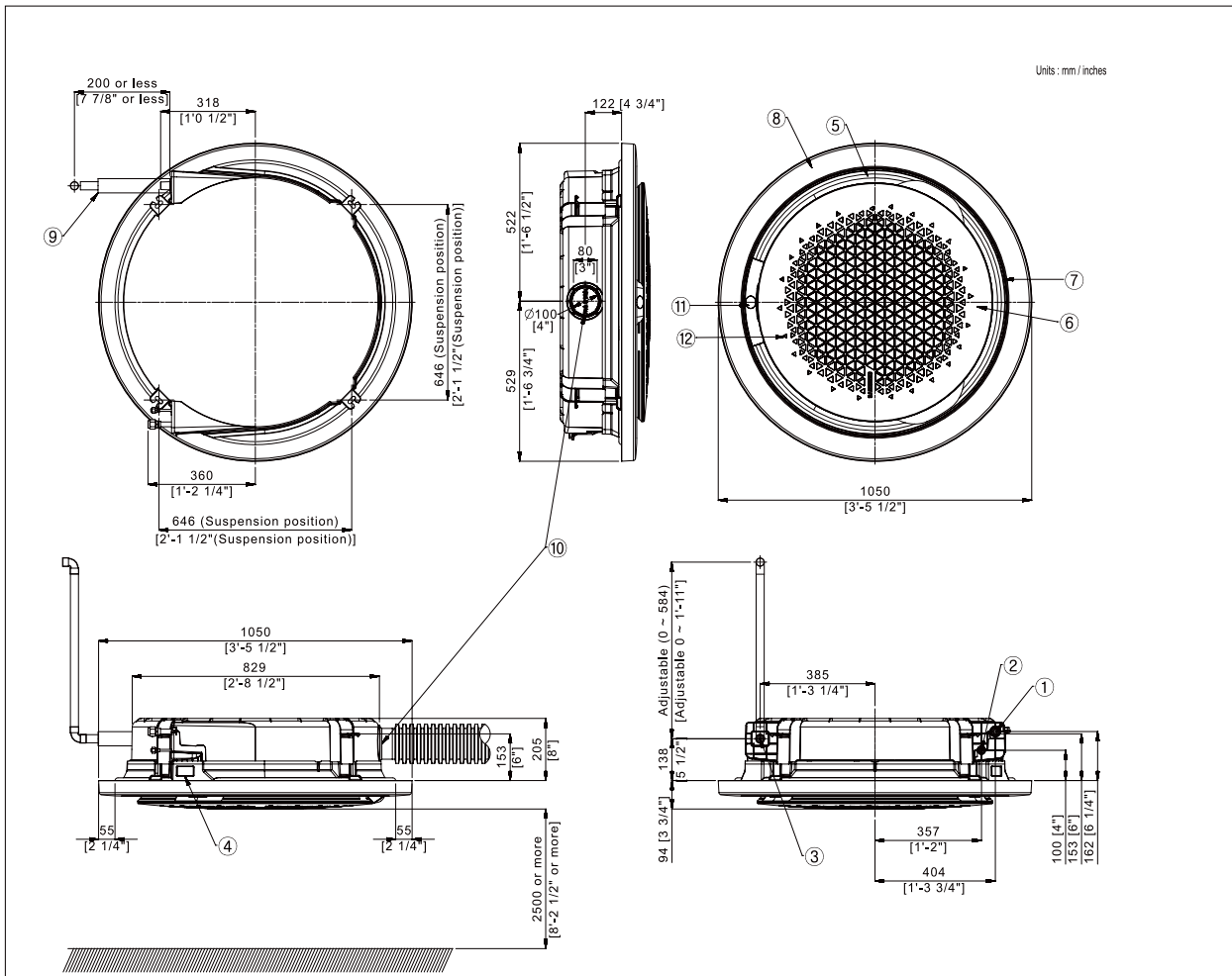

Note

1. Make sure the spacing between the ceiling and the cassette is no more than 10mm[3/8"].
2. When the conditions exceed 30°C[86°F] and RH 80% in the ceiling or fresh air is induced into the ceiling, and additional insulation is required (polyethylene foam, thickness 10mm[3/8"] or more)
3. Open type panel model code : PC4NUNMAN
4. The circular panel is by default available in exposed installation.
5. Make inspection holes on the ceiling for easier installation and maintenance, as shown in the following table.
(The size of an inspection hole must be at least 450 mm x 450 mm.)
6. A suspended ceiling structure can substitute for the inspection holes.

Category	Inspection hole		
	Recessed installation		Exposed installation
	Integrated	Suspended	
Square panel	1 ea		
Circular panel	2 ea		

Table of descriptions

1	Refrigerant gas pipe	7	Suction rim for Booster fan
2	Refrigerant liquid pipe	8	Decoration cover
3	Condensate drain	9	Drain hose
4	Power & Comm. wiring conduits	10	Fresh air intake knock out hole
5	Air discharge opening	11	Display window
6	Air suction grille	12	Infrared receiver

3 Dimensional drawing

360 Cassette

AM112KN4DEH/EU, AM128KN4DEH/EU, AM140KN4DEH/EU

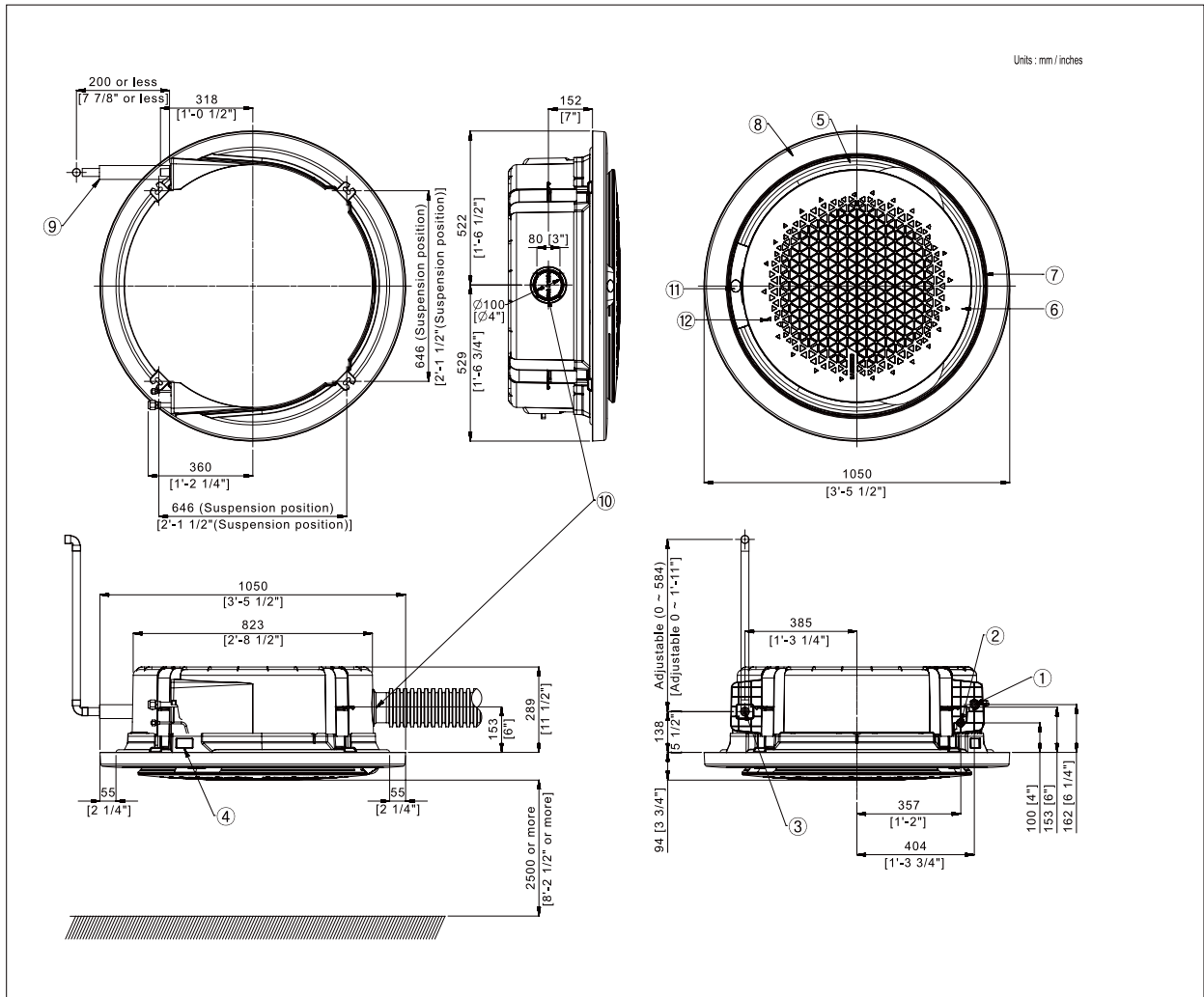

Note

1. Make sure the spacing between the ceiling and the cassette is no more than 10mm[3/8"].
2. When the conditions exceed 30°C[86°F] and RH 80% in the ceiling or fresh air is induced into the ceiling, and additional insulation is required (polyethylene foam, thickness 10mm[3/8"] or more)
3. Open type panel model code : PC4NUNMAN
4. The circular panel is by default available in exposed installation.
5. Make inspection holes on the ceiling for easier installation and maintenance, as shown in the following table.
(The size of an inspection hole must be at least 450 mm x 450 mm.)
6. A suspended ceiling structure can substitute for the inspection holes.

Category	Inspection hole		
	Recessed installation		Exposed installation
	Integrated	Suspended	
Square panel	1 ea		
Circular panel	2 ea		

Table of descriptions

1	Refrigerant gas pipe	7	Suction rim for Booster fan
2	Refrigerant liquid pipe	8	Decoration cover
3	Condensate drain	9	Drain hose
4	Power & Comm. wiring conduits	10	Fresh air intake knock out hole
5	Air discharge opening	11	Display window
6	Air suction grille	12	Infrared receiver

4 Electrical wiring diagram

360 Cassette

AM045KN4DEH/EU, AM056KN4DEH/EU, AM071KN4DEH/EU, AM090KN4DEH/EU, AM112KN4DEH/EU, AM128KN4DEH/EU, AM140KN4DEH/EU

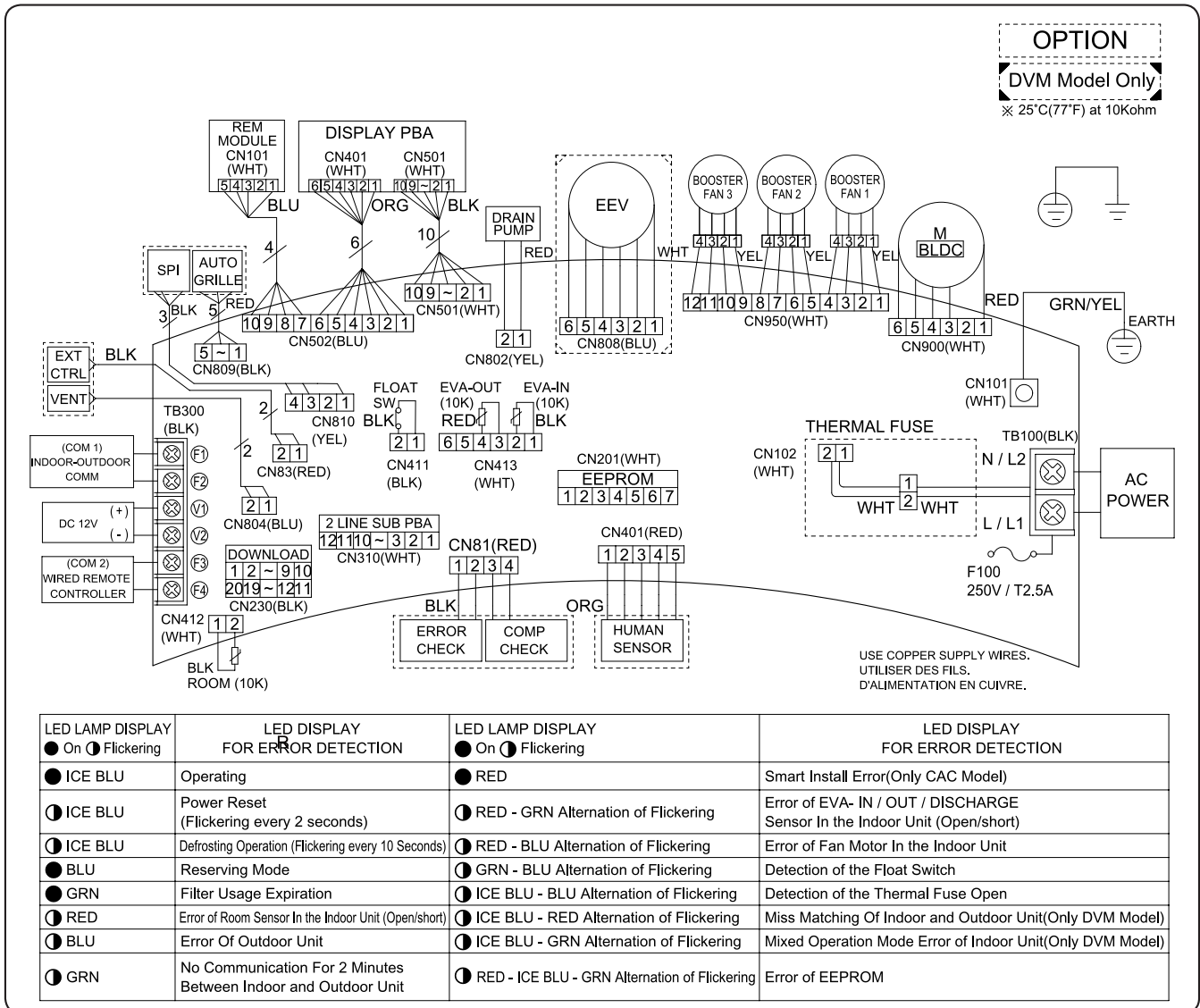

M-BLDC	BLDC Motor	SPI	S-Plasma ion	ROOM(10K)	Thermistor ROOM OUT(10K)
Thermal Fuse	Terminal Block thermal fuse	EEV	Electronic Expansion Valve	EVA-IN(10K)	Thermistor EVA IN(10K)
		F100	Main fuse, 250V/T2.5A	EVA-OUT(10K)	Thermistor EVA OUT(10K)

NOTE

- This wiring diagram applies only to the indoor unit.
- Symbols show as follow :
BLK: black, RED: red, BLU: blue, WHT: white, YEL: yellow, BRN: brown, SKY: sky blue, GRN: green
- For connection wiring indoor-outdoor transmission F1-F2, indoor-wired remote controller transmission F3-F4.
- ⊕ Protective earth(SCREW)

5 Sound pressure level

360 Cassette

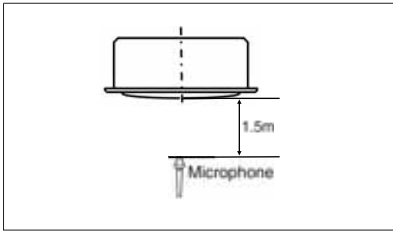

Unit: dB(A)

Model	High	Low
AM045KN4DEH/EU	33	29
AM056KN4DEH/EU	34	29
AM071KN4DEH/EU	36	30
AM090KN4DEH/EU	40	32

Note

Specifications may be subject to change without prior notice.
 Sound pressure level is obtained in an anechoic room.
 Sound pressure level is a relative value, depending on the distance and acoustic environment.
 Sound pressure level may differ depending on operation condition.
 dBA = A-weighted sound pressure level
 Reference acoustic pressure 0 dB= 20 uPa

NR Curve

1) AM045KN4DEH/EU

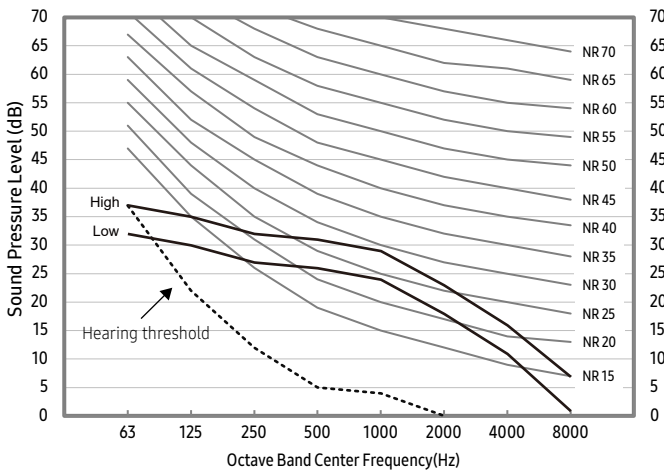

2) AM056KN4DEH/EU

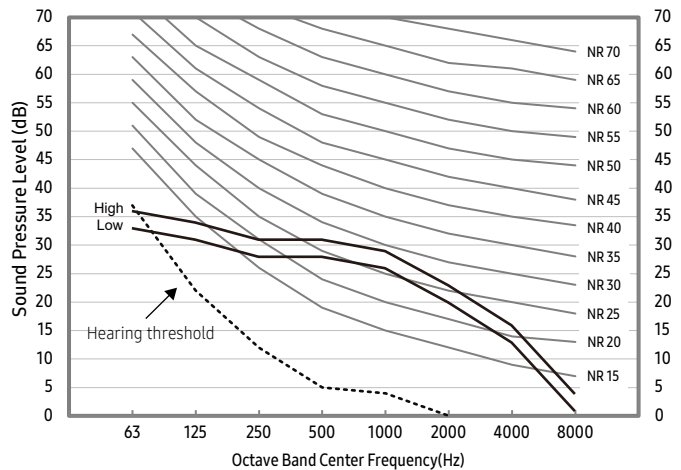

3) AM071KN4DEH/EU

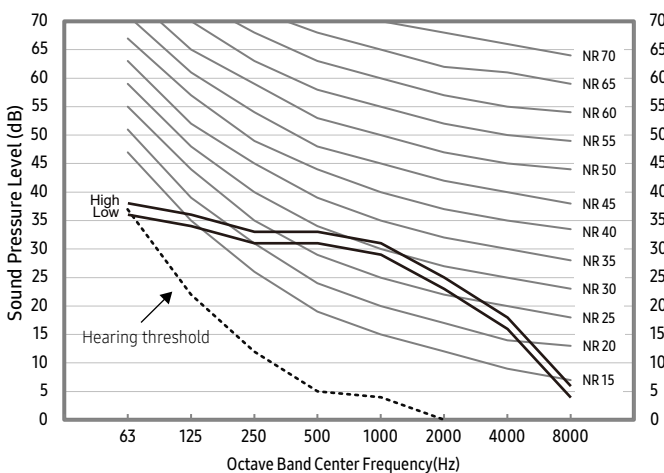

4) AM090KN4DEH/EU

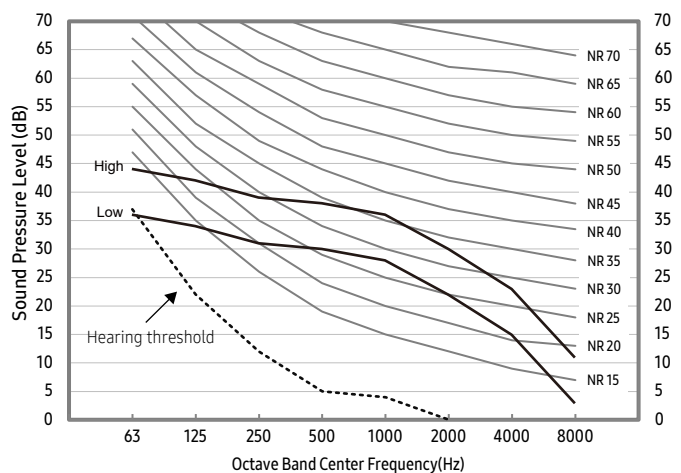

5 Sound pressure level

360 Cassette

Unit: dB(A)

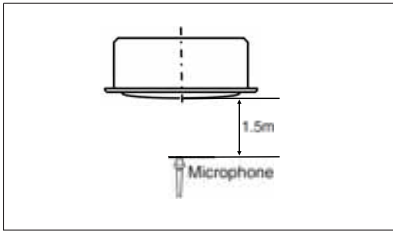

Model	High	Low
AM112KN4DEH/EU	40	32
AM128KN4DEH/EU	42	33
AM140KN4DEH/EU	44	35

Note

Specifications may be subject to change without prior notice.
 Sound pressure level is obtained in an anechoic room.
 Sound pressure level is a relative value, depending on the distance and acoustic environment.
 Sound pressure level may differ depending on operation condition.
 dBA = A-weighted sound pressure level
 Reference acoustic pressure 0 dB= 20 uPa

NR Curve

1) AM112KN4DEH/EU

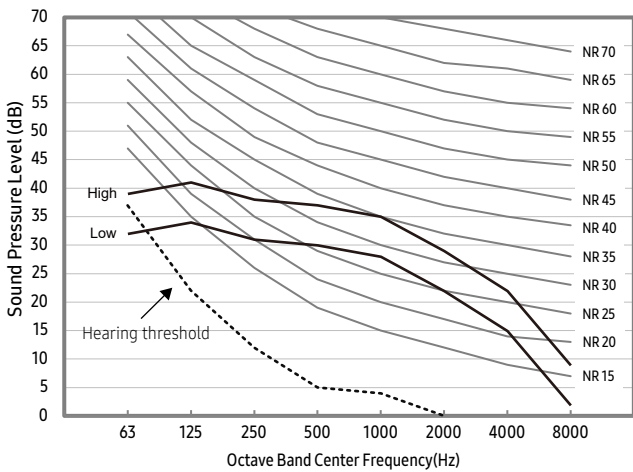

2) AM128KN4DEH/EU

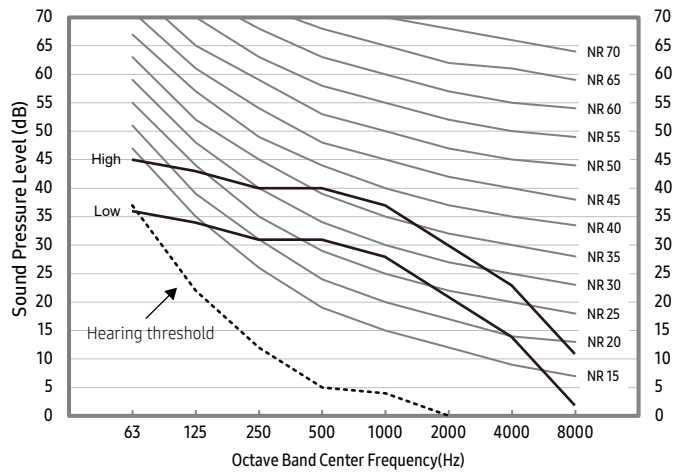

3) AM140KN4DEH/EU

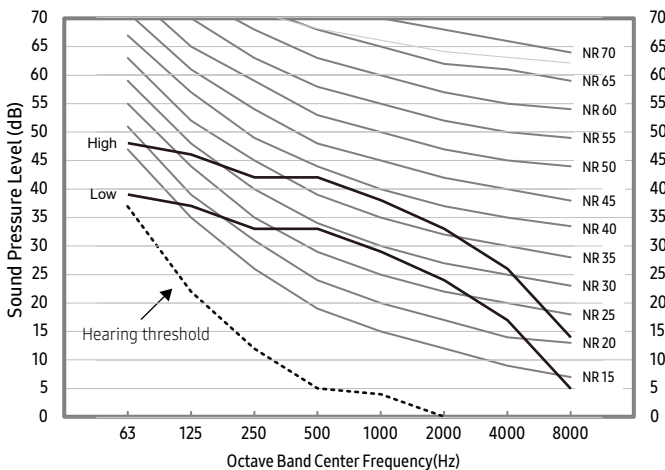

6 Sound power level

360 Cassette

Note

- . Specifications may be subject to change without prior notice.
- . Sound power level is an absolute value that a sound source generates.
- . dBA = A-weighted sound power level.
- . Reference power : 1pW.
- . Measured according to ISO 3741

Unit: dB(A)

Model	Power
AM045KN4DEH/EU	50
AM056KN4DEH/EU	51
AM071KN4DEH/EU	53
AM090KN4DEH/EU	57

1)AM045KN4DEH/EU

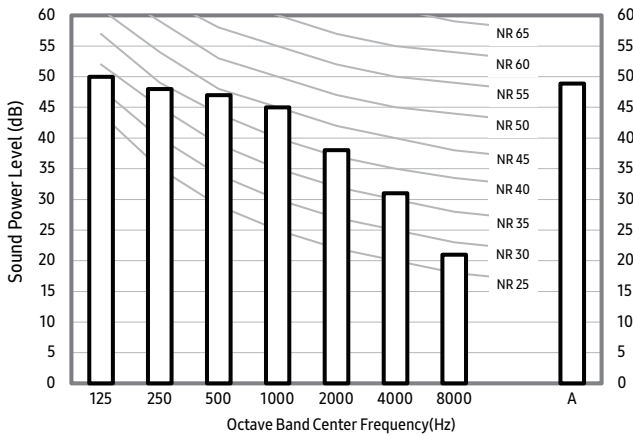

2)AM056KN4DEH/EU

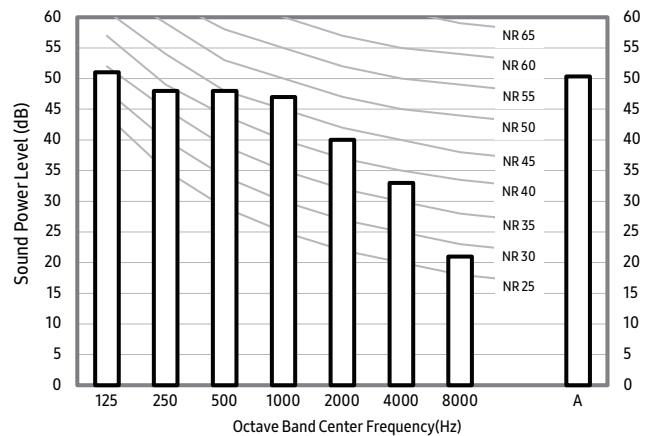

3)AM071KN4DEH/EU

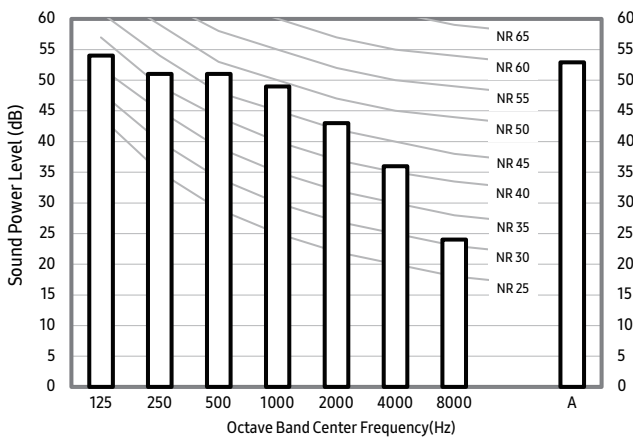

4)AM090KN4DEH/EU

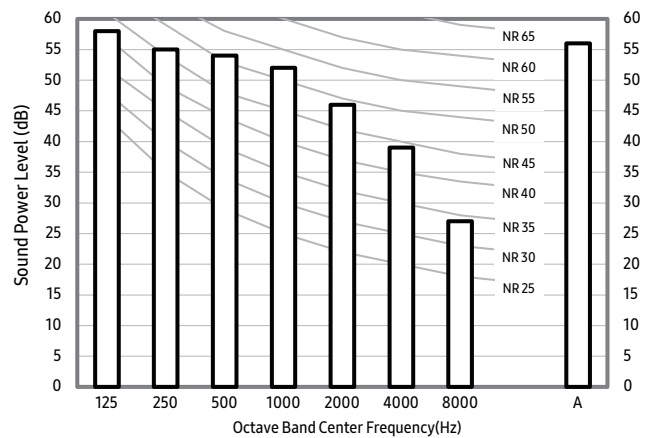

6 Sound power level

360 Cassette

Note

- . Specifications may be subject to change without prior notice.
- . Sound power level is an absolute value that a sound source generates.
- . dBA = A-weighted sound power level.
- . Reference power : 1pW.
- . Measured according to ISO 3741

Unit: dB(A)

Model	Power
AM112KN4DEH/EU	58
AM128KN4DEH/EU	60
AM140KN4DEH/EU	61

1)AM112KN4DEH/EU

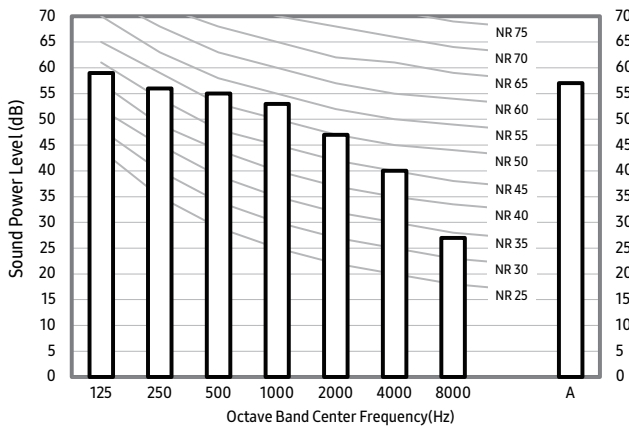

2)AM128KN4DEH/EU

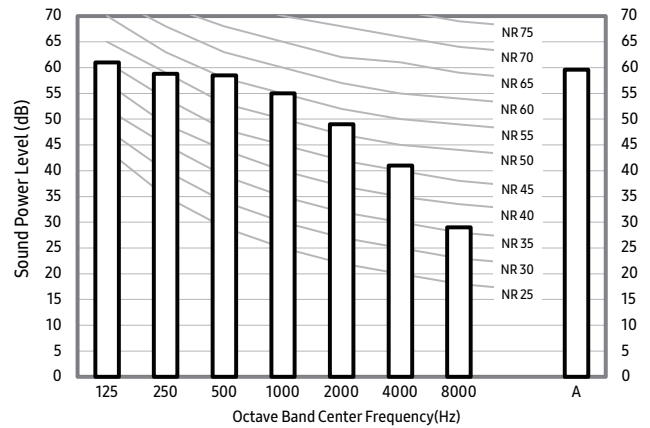

3)AM140KN4DEH/EU

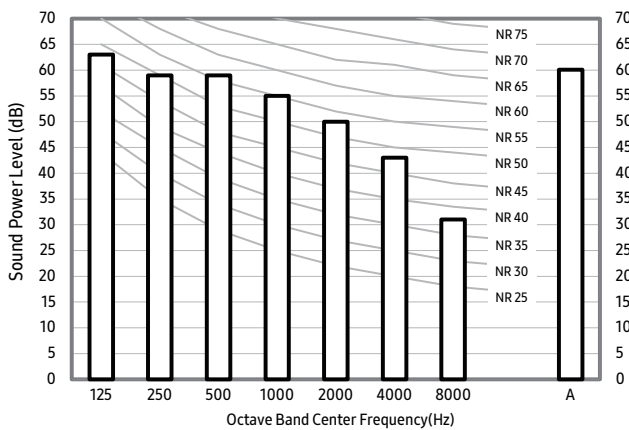

7 Temperature and air flow distribution

360 Cassette

AM045KN4DEH/EU

(1) Cooling air velocity distribution

Discharge angle : 60°

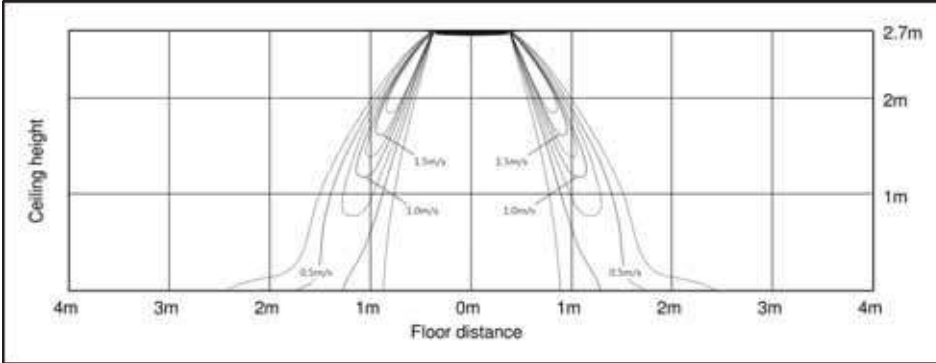

(2) Cooling temperature distribution

Discharge angle : 60°

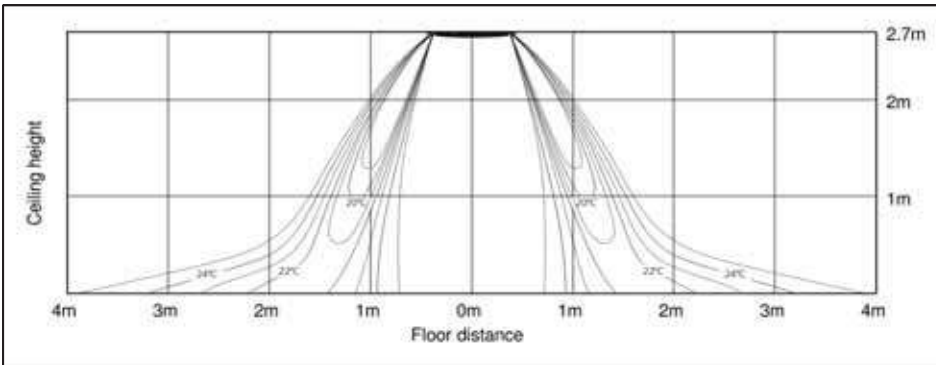

(3) Heating air velocity distribution

Discharge angle : 60°

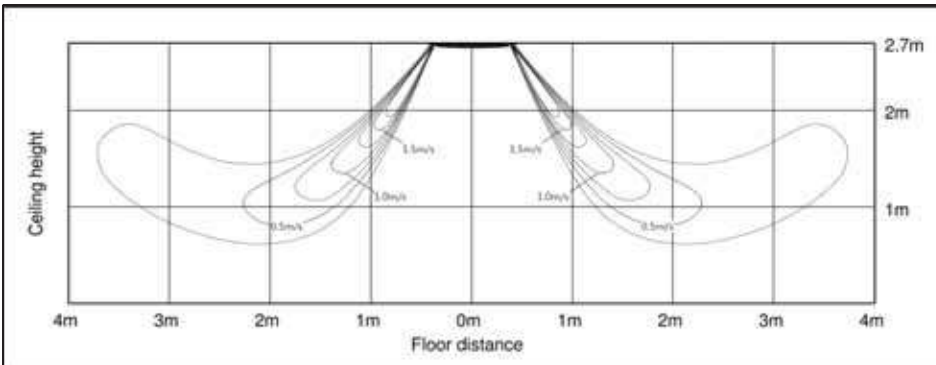

(4) Heating temperature distribution

Discharge angle : 60°

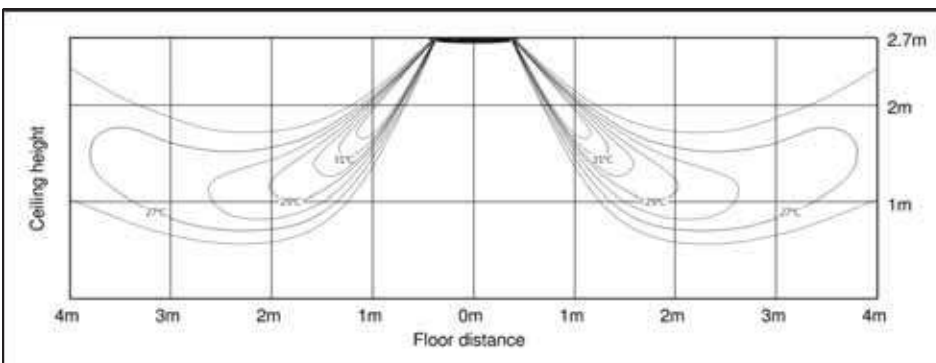

7 Temperature and air flow distribution

360 Cassette

AM056KN4DEH/EU

(1) Cooling air velocity distribution

Discharge angle : 60°

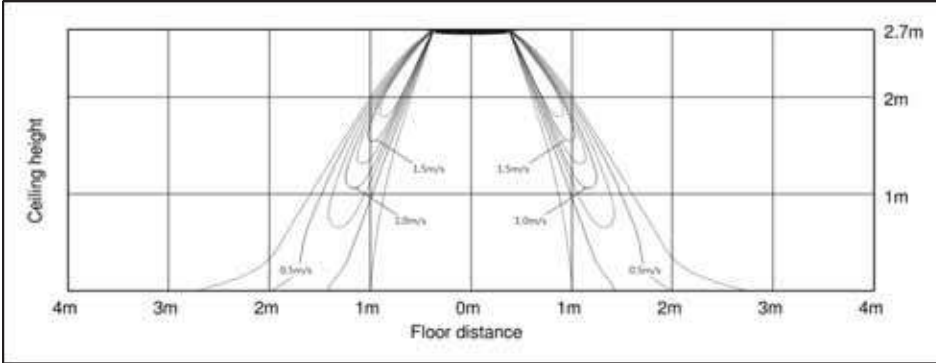

(2) Cooling temperature distribution

Discharge angle : 60°

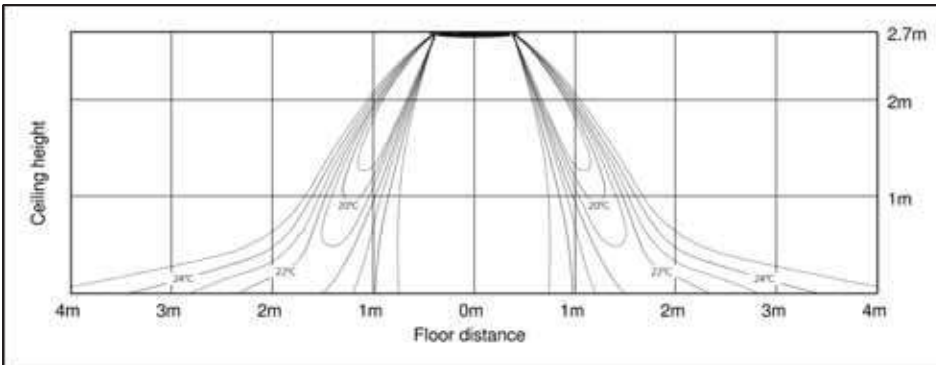

(3) Heating air velocity distribution

Discharge angle : 60°

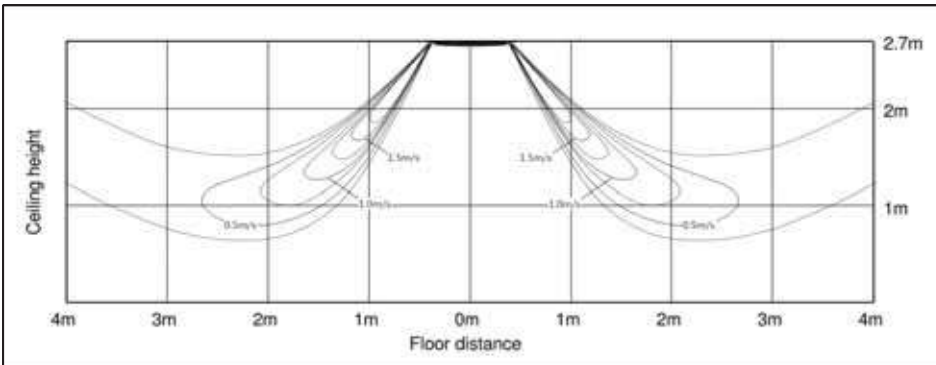

(4) Heating temperature distribution

Discharge angle : 60°

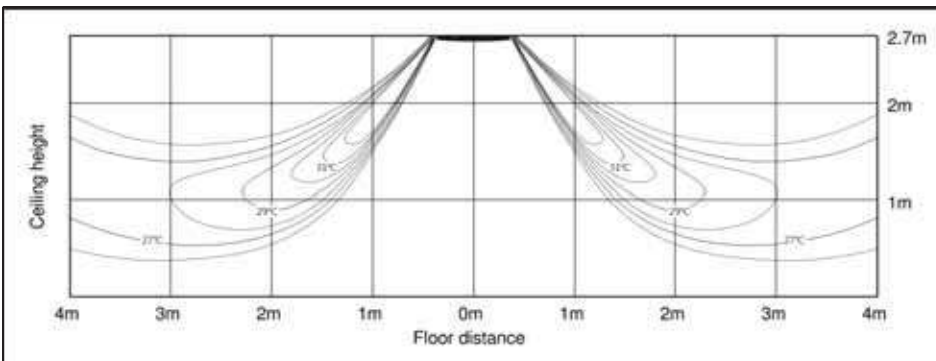

7 Temperature and air flow distribution

360 Cassette

AM071KN4DEH/EU

(1) Cooling air velocity distribution

Discharge angle : 60°

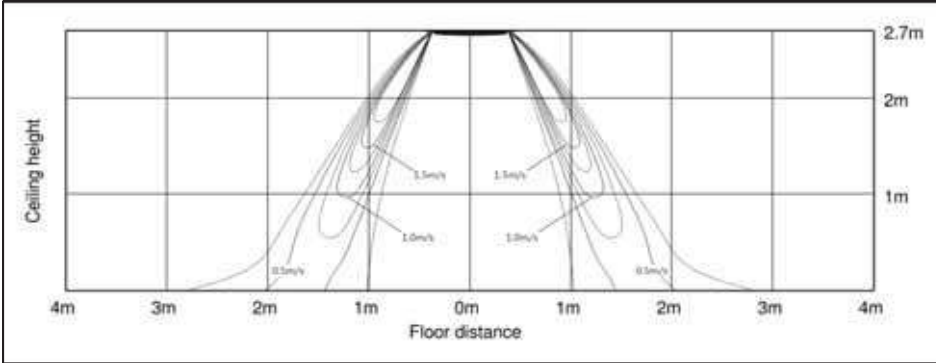

(2) Cooling temperature distribution

Discharge angle : 60°

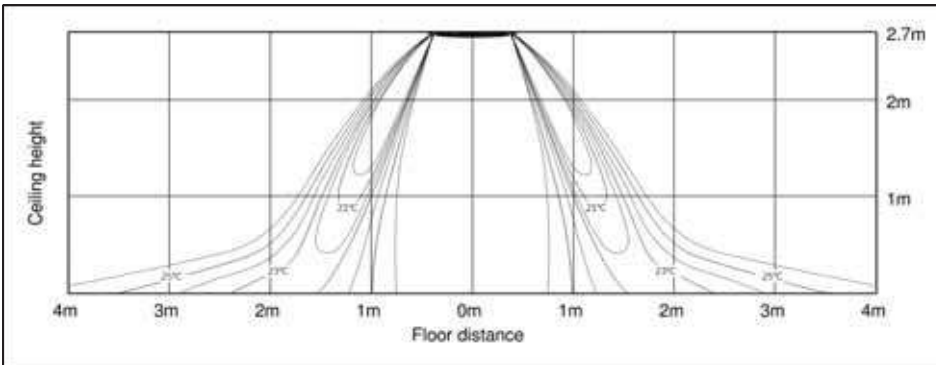

(3) Heating air velocity distribution

Discharge angle : 60°

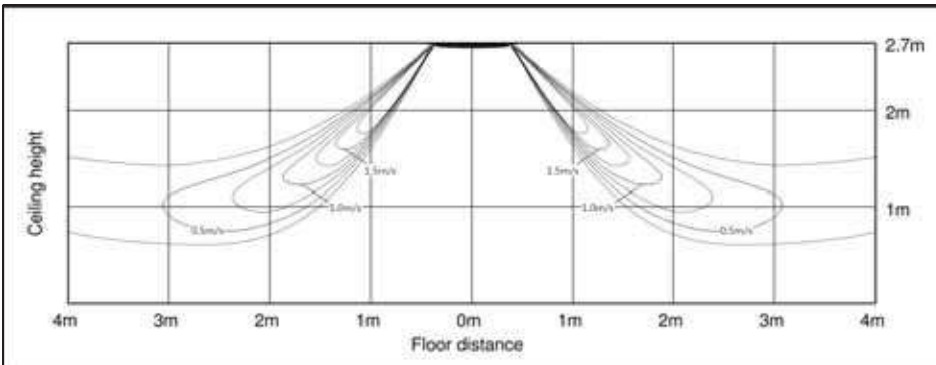

(4) Heating temperature distribution

Discharge angle : 60°

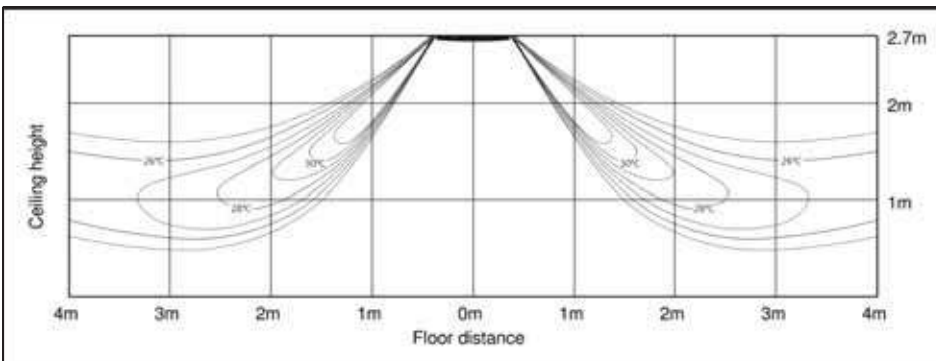

7 Temperature and air flow distribution

360 Cassette

AM090KN4DEH/EU

(1) Cooling air velocity distribution

Discharge angle : 60°

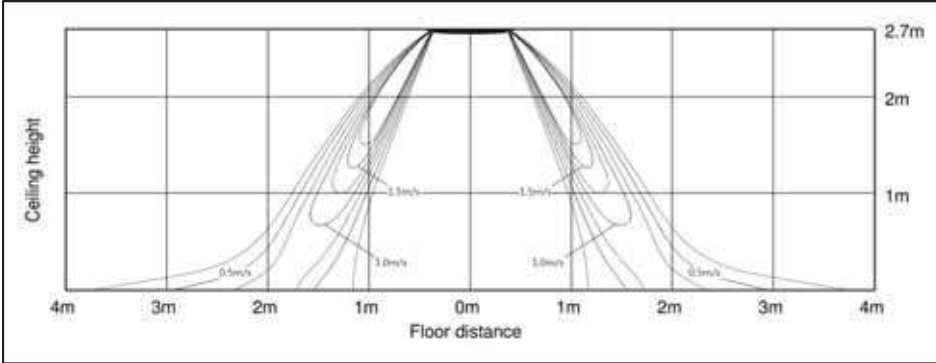

(2) Cooling temperature distribution

Discharge angle : 60°

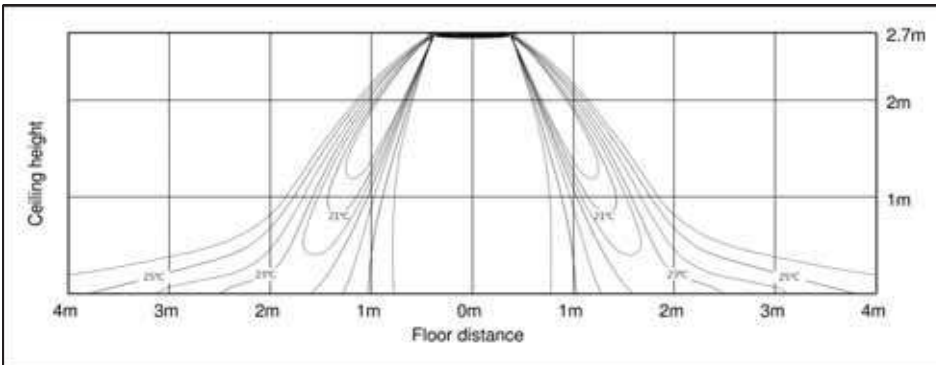

(3) Heating air velocity distribution

Discharge angle : 60°

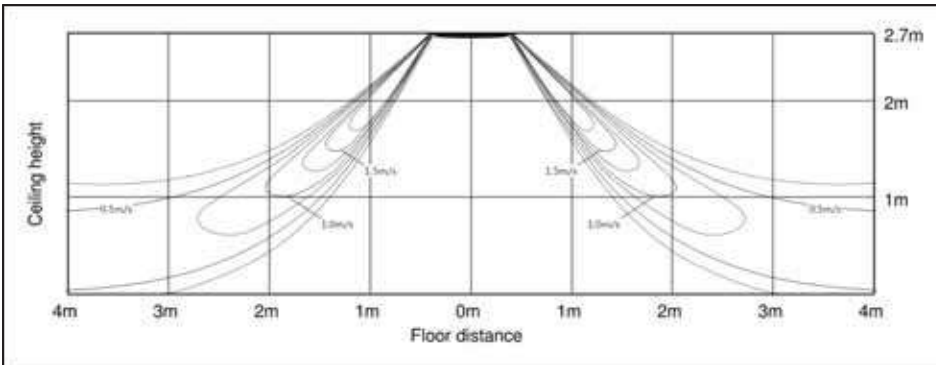

(4) Heating temperature distribution

Discharge angle : 60°

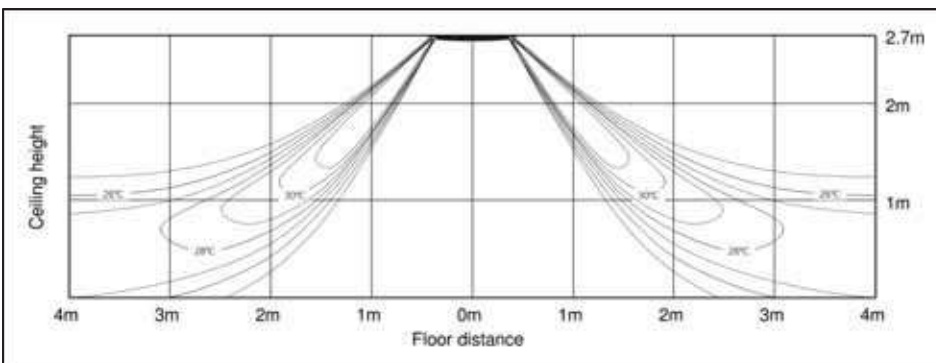

7 Temperature and air flow distribution

360 Cassette

AM112KN4DEH/EU

(1) Cooling air velocity distribution

Discharge angle : 60°

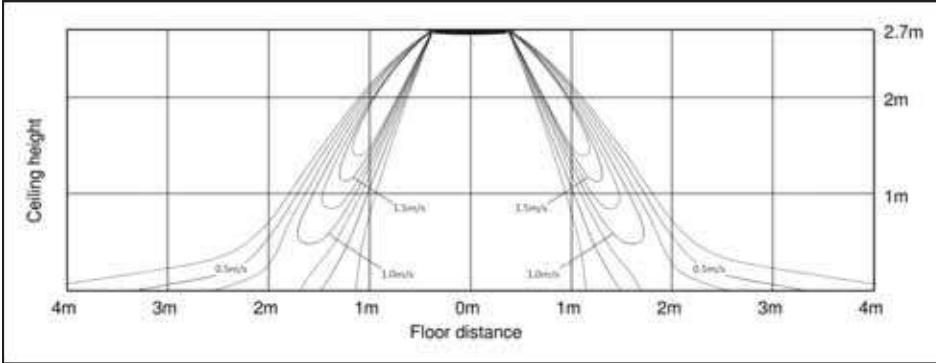

(2) Cooling temperature distribution

Discharge angle : 60°

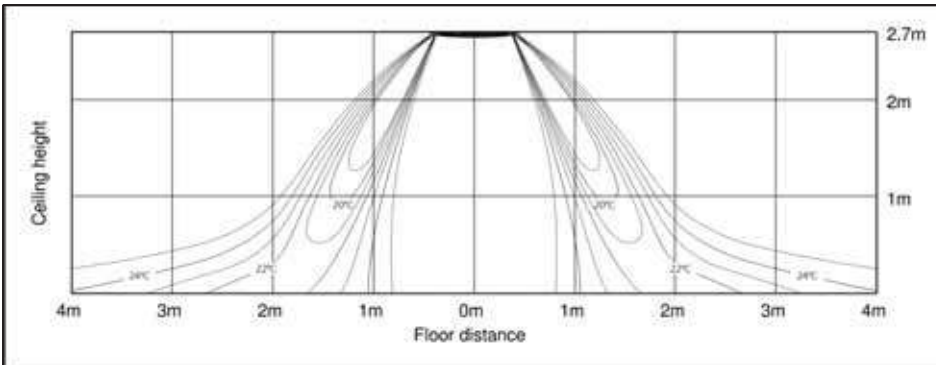

(3) Heating air velocity distribution

Discharge angle : 60°

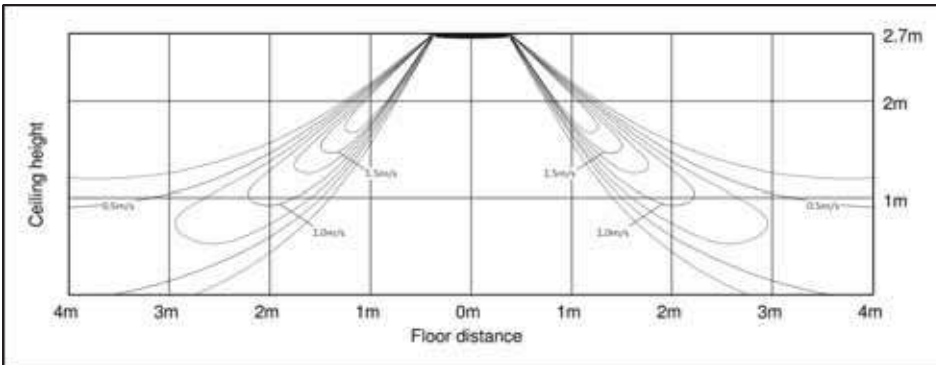

(4) Heating temperature distribution

Discharge angle : 60°

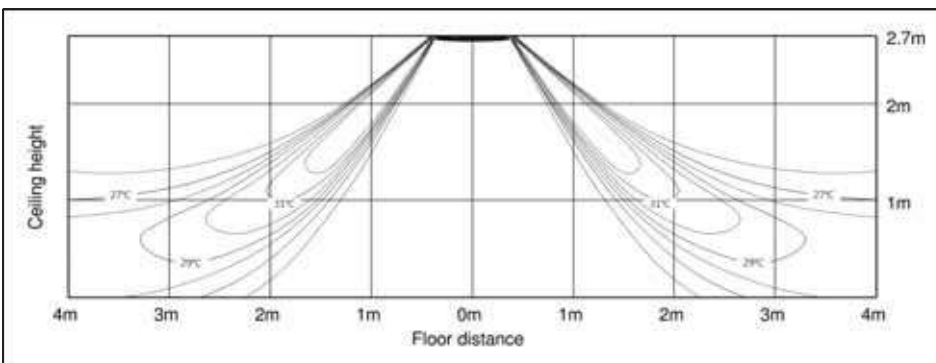

7 Temperature and air flow distribution

360 Cassette

AM128KN4DEH/EU

(1) Cooling air velocity distribution

Discharge angle : 60°

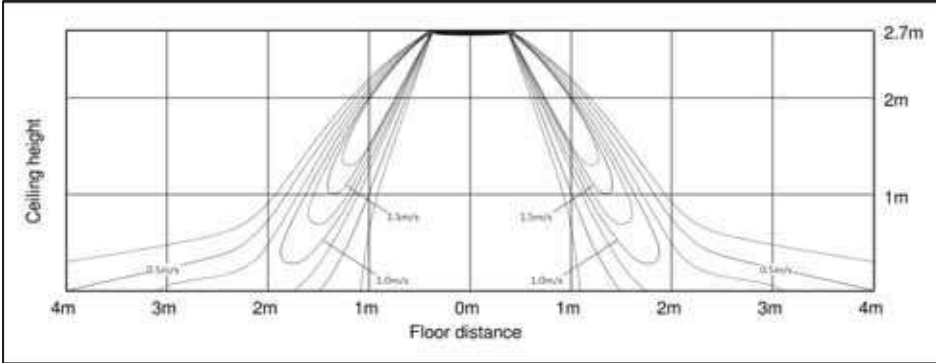

(2) Cooling temperature distribution

Discharge angle : 60°

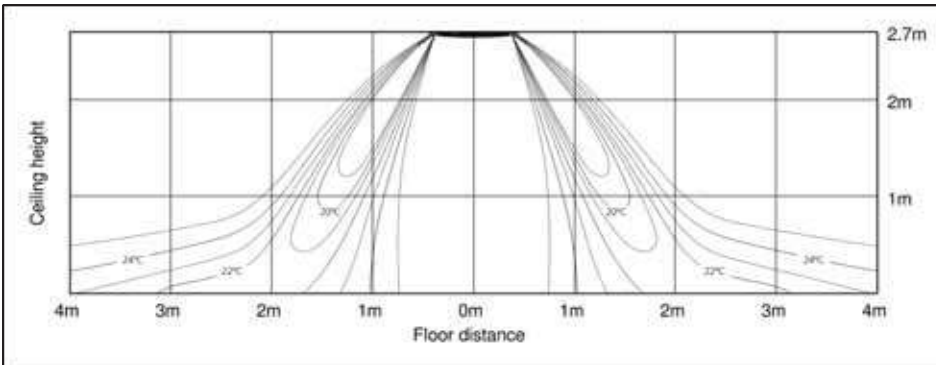

(3) Heating air velocity distribution

Discharge angle : 60°

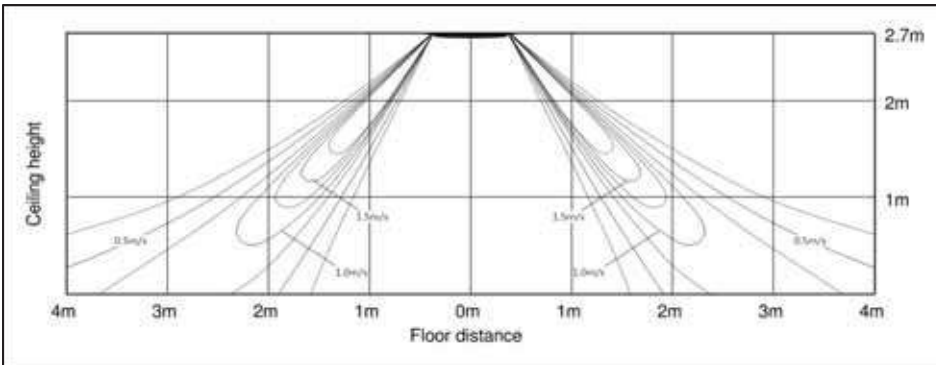

(4) Heating temperature distribution

Discharge angle : 60°

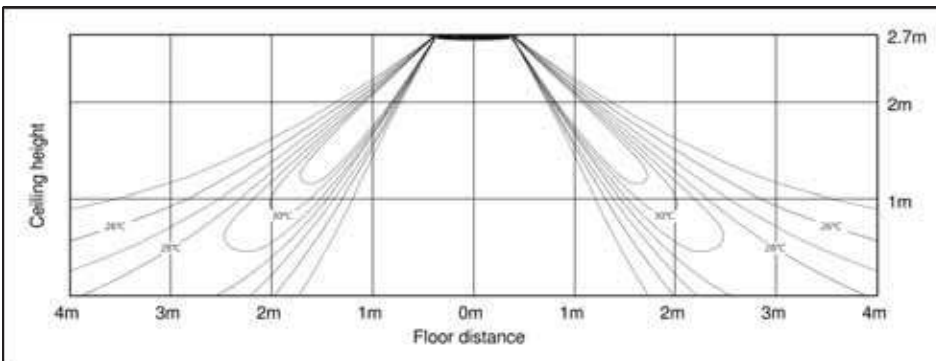

7 Temperature and air flow distribution

360 Cassette

AM140KN4DEH/EU

(1) Cooling air velocity distribution

Discharge angle : 60°

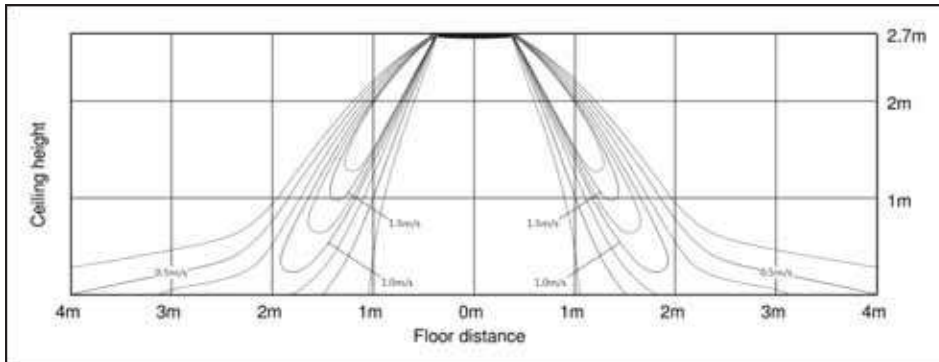

(2) Cooling temperature distribution

Discharge angle : 60°

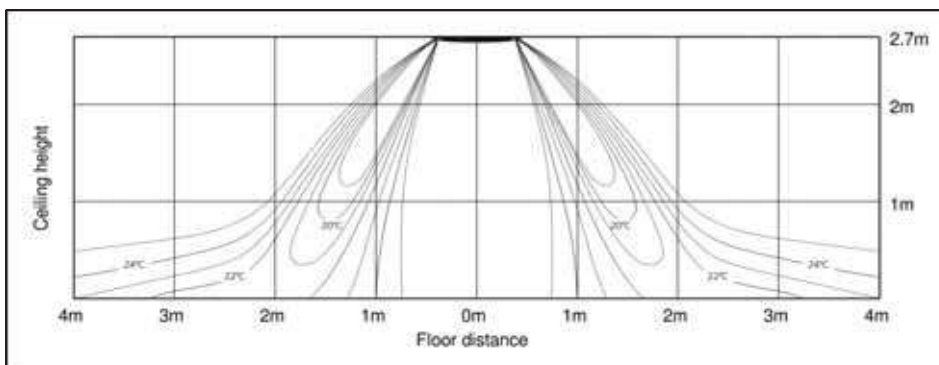

(3) Heating air velocity distribution

Discharge angle : 60°

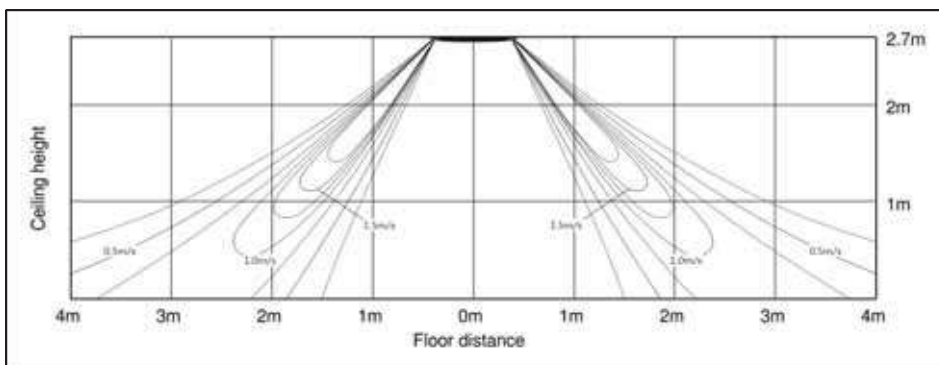

(4) Heating temperature distribution

Discharge angle : 60°

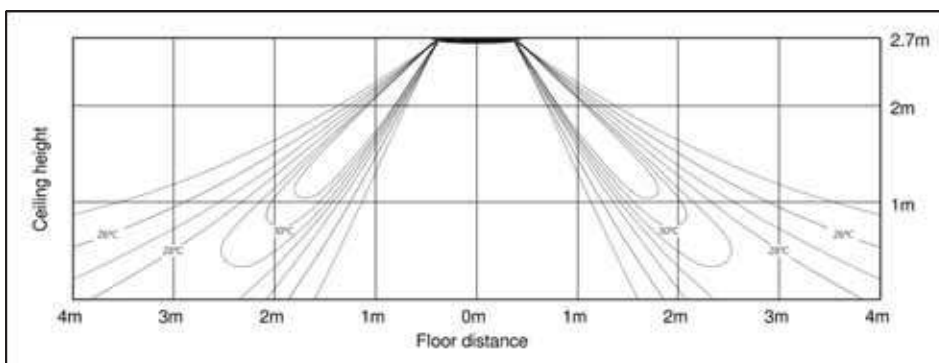

Duct S

- 1 *Specification*
- 2 *Summary Table*
- 3 *Capacity Table*
- 4 *Dimensional Drawing*
- 5 *Center of Gravity*
- 6 *Electrical Wiring Diagram*
- 7 *Sound data*
- 8 *Fan Characteristics*
- 9 *Piping Diagram*

1. Specification

Duct S

Model CODE				AM036HNMPKH/EU	AM045HNMPKH/EU	AM056HNMPKH/EU
Power Supply			Φ, #, V, Hz	1,2,220~240,50	1,2,220~240,50	1,2,220~240,50
Mode			-	HP/HR	HP/HR	HP/HR
Performance	Capacity (Nominal)	Cooling (ISO/SASO)	kW	3.6	4.5	5.6
			Btu/h	12,300	15,400	19,100
		Heating	kW	4.0	5.0	6.3
			Btu/h	13,600	17,100	21,500
Power	Power Input (Nominal)	Cooling	W	50	60	70
		Heating	W	50	60	70
	Current Input (Nominal)	Cooling	A	0.5	0.6	0.7
		Heating	A	0.5	0.6	0.7
	Current	MCA	A	1.04	1.26	1.26
		MFA/MOP	A	15	15	15
Heat exchanger	Type		-	FME	FME	FME
	Material	Fin	-	Al	Al	Al
		Tube	-	Al	Al	Al
	Fin Treatment		-	Anti-corrosion	Anti-corrosion	Anti-corrosion
Fan	Type		-	Sirocco Fan	Sirocco Fan	Sirocco Fan
	Quantity		EA	2	2	2
	Air Flow Rate	H/M/L (UL)	m ³ /min	12.0 / 9.5 / 8.0	14.0 / 11.0 / 8.0	16.0 / 13.5 / 11.0
			l/s	200 / 158 / 133	233 / 183 / 133	267 / 225 / 183
	External Pressure	Min / Std / Max	mmAq	0 / 2.5 / 15	0 / 3 / 15	0 / 3 / 15
Pa			0 / 24.5 / 147.2	0 / 29.4 / 147.2	0 / 29.4 / 147.2	
Fan Motor	Model		-	BLDC motor(feedback)	BLDC motor(feedback)	BLDC motor(feedback)
	Output x n		W	153 x 1	153 x 1	153 x 1
Piping Connections	Liquid Pipe	Type	-	Flare connection	Flare connection	Flare connection
		Φ,mm	-	6.35	6.35	6.35
		Φ, inch	-	1/4"	1/4"	1/4"
	Gas Pipe	Type	-	Flare connection	Flare connection	Flare connection
		Φ,mm	-	12.7	12.7	12.7
		Φ, inch	-	1/2"	1/2"	1/2"
	Heat insulation		-	Both liquid and gas pipes	Both liquid and gas pipes	Both liquid and gas pipes
Drain Pipe		Φ,mm	VP25 (OD 32,ID 25)	VP25 (OD 32,ID 25)	VP25 (OD 32,ID 25)	
Wiring connections	For power supply	Minimum	mm2	1.5	1.5	1.5
	For connection with indoor	Minimum	mm2	0.75	0.75	0.75
		Remark	-	F1,F2	F1,F2	F1,F2
Refrigerant	Type		-	R410A	R410A	R410A
	Control Method		-	EEV Included	EEV Included	EEV Included
Sound	Sound Pressure	High / Mid / Low	dB(A)	29/26/23	31/28/24	32/29/25
	Sound Power	Cooling (Nominal)	dB(A)	40	44	45
Dimensions	Net Weight		kg	25.5	25.5	25.5
	Shipping Weight		kg	30	30	30
	Net Dimensions (W×H×D)		mm	850 x 250 x 700	850 x 250 x 700	850 x 250 x 700
	Shipping Dimensions (W×H×D)		mm	1064 x 320 x 784	1064 x 320 x 784	1064 x 320 x 784
Air filter	Type		-	Removable / Washable / Mildew proof	Removable / Washable / Mildew proof	Removable / Washable / Mildew proof
Additional Accessories	Drain pump	Drain pump	Model	MDP-G075SQ(built-in) MDP-G075SP(external)	MDP-G075SQ(built-in) MDP-G075SP(external)	MDP-G075SQ(built-in) MDP-G075SP(external)
		Max. lifting Height	mm	750	750	750

NOTE

- Mode : HP(Heat Pump), HR(Heat Recovery)
- Nominal Cooling : Indoor temperature 27°CDB / 19°CWB, Outdoor temperature 35°CDB/24°CWB, Refrigerant pipe length 7.5m, Level difference 0m.
- Nominal Heating : Indoor temperature 20°CDB / 15°CWB, Outdoor temperature 7°CDB / 6°CWB, Refrigerant pipe length 7.5m, Level difference 0m.
- Sound pressure level was acquired in an anechoic room. Thus actual noise level may be different depending on the installation conditions.
- These products contain R410A which is fluorinated greenhouse gas.
- Specifications may be subject to change without prior notice.
- Select wire size based on the value of MCA

1. Specification

Duct S

Model CODE				AM071HNMPKH/EU	AM090HNMPKH/EU	AM112HNMPKH/EU
Power Supply			Φ, #, V, Hz	1,2,220-240,50	1,2,220-240,50	1,2,220-240,50
Mode			-	HP/HR	HP/HR	HP/HR
Performance	Capacity (Nominal)	Cooling (ISO/SASO)	kW	7.1	9	11.2
			Btu/h	24,200	30,700	38,200
		Heating	kW	8.0	10.0	12.5
			Btu/h	27,300	34,100	42,700
Power	Power Input (Nominal)	Cooling	W	120	145	165
		Heating		120	145	165
	Current Input (Nominal)	Cooling	A	1.0	1.2	1.4
		Heating		1.0	1.2	1.4
	Current	MCA	A	1.52	2.03	2.51
		MFA/MOP		15	15	15
Heat exchanger	Type		-	FME	FME	FME
	Material	Fin	-	Al	Al	Al
		Tube	-	Al	Al	Al
	Fin Treatment		-	Anti-corrosion	Anti-corrosion	Anti-corrosion
Fan	Type		-	Sirocco Fan	Sirocco Fan	Sirocco Fan
	Quantity		EA	2	3	3
	Air Flow Rate	H/M/L (UL)	m ³ /min	22.0 / 19.0 / 16.0	29.0 / 25.0 / 22.0	35.0 / 29.0 / 22.0
			l/s	367 / 317 / 267	483 / 417 / 367	583 / 483 / 367
	External Pressure	Min / Std / Max	mmAq	0 / 3 / 15	0 / 4 / 15	0 / 5.2 / 15
Pa			0 / 29.4 / 147.2	0 / 39.2 / 147.2	0 / 51.0 / 147.2	
Fan Motor	Model		-	BLDC motor(feedback)	BLDC motor(feedback)	BLDC motor(feedback)
	Output x n		W	153 x 1	153 x 1	244 x 1
Piping Connections	Liquid Pipe		Type	Flare connection	Flare connection	Flare connection
			Φ,mm	9.52	9.52	9.52
			Φ, inch	3/8"	3/8"	3/8"
	Gas Pipe		Type	Flare connection	Flare connection	Flare connection
			Φ,mm	15.88	15.88	15.88
			Φ, inch	5/8"	5/8"	5/8"
	Heat insulation		-	Both liquid and gas pipes	Both liquid and gas pipes	Both liquid and gas pipes
Drain Pipe		Φ,mm	VP25 (OD 32,ID 25)	VP25 (OD 32,ID 25)	VP25 (OD 32,ID 25)	
Wiring connections	For power supply	Minimum	mm ²	1.5	1.5	1.5
	For connection with indoor	Minimum	mm ²	0.75	0.75	0.75
		Remark	-		F1,F2	F1,F2
Refrigerant	Type		-	R410A	R410A	R410A
	Control Method		-	EEV Included	EEV Included	EEV Included
Sound	Sound Pressure	High / Mid / Low	dB(A)	37/33/29	38/35/32	38/35/32
	Sound Power	Cooling (Nominal)		47	44	45
Dimensions	Net Weight		kg	25.5	33	38
	Shipping Weight		kg	30	38.5	43.5
	Net Dimensions (W×H×D)		mm	850 x 250 x 700	1200 x 250 x 700	1300 x 300 x 700
	Shipping Dimensions (W×H×D)		mm	1064 x 320 x 784	1429 x 320 x 779	1529 x 370 x 779
Air filter	Type		-	Removable / Washable / Mildew proof	Removable / Washable / Mildew proof	Removable / Washable / Mildew proof
Additional Accessories	Drain pump	Drain pump	Model	MDP-G075SQ(built-in) MDP-G075SP(external)	MDP-G075SQ(built-in) MDP-G075SP(external)	MDP-G075SQ(built-in) MDP-G075SP(external)
		Max. lifting Height	mm	750	750	750

NOTE

- Mode : HP(Heat Pump), HR(Heat Recovery)
- Nominal Cooling : Indoor temperature 27°CDB / 19°CWB, Outdoor temperature 35°CDB/24°CWB, Refrigerant pipe length 7.5m, Level difference 0m.
- Nominal Heating : Indoor temperature 20°CDB / 15°CWB, Outdoor temperature 7°CDB / 6°CWB, Refrigerant pipe length 7.5m, Level difference 0m.
- Sound pressure level was acquired in an anechoic room. Thus actual noise level may be different depending on the installation conditions.
- These products contain R410A which is fluorinated greenhouse gas.
- Specifications may be subject to change without prior notice.
- Select wire size based on the value of MCA

1. Specification

Duct S

Model CODE				AM128HNMPKH/EU	AM140HNMPKH/EU	AM112HNHPKH/EU
Power Supply			Φ, #, V, Hz	1,2,220~240,50	1,2,220~240,50	1,2,220~240,50
Mode			-	HP/HR	HP/HR	HP/HR
Performance	Capacity (Nominal)	Cooling (ISO/SASO)	kW	12.8	14	11.2
			Btu/h	43,700	47,800	38,200
		Heating	kW	13.8	16.0	12.5
			Btu/h	47,100	54,600	42,700
Power	Power Input (Nominal)	Cooling	W	175	215	205
		Heating	W	175	215	205
	Current Input (Nominal)	Cooling	A	1.5	1.7	205.0
		Heating	A	1.5	1.7	1.2
	Current	MCA	A	2.51	2.51	2.92
		MFA/MOP	A	15	15	15
Heat exchanger	Type		-	FME	FME	FME
	Material	Fin	-	Al	Al	Al
		Tube	-	Al	Al	Al
	Fin Treatment		-	Anti-corrosion	Anti-corrosion	Anti-corrosion
Fan	Type		-	Sirocco Fan	Sirocco Fan	Sirocco Fan
	Quantity		EA	3	3	3
	Air Flow Rate	H/M/L (UL)	m ³ /min	38.0 / 32.0 / 25.0	42.0 / 34.0 / 25.0	35.0 / 29.0 / 22.0
			l/s	633 / 533 / 417	700 / 567 / 417	583 / 483 / 367
	External Pressure	Min / Std / Max	mmAq	0 / 5.2 / 15	0 / 5.2 / 15	3 / 6.2 / 20
Pa			0 / 51.0 / 147.2	0 / 51.0 / 147.2	0 / 60.8 / 196.2	
Fan Motor	Model		-	BLDC motor(feedback)	BLDC motor(feedback)	BLDC motor(feedback)
	Output x n		W	244 x 1	244 x 1	350 x 1
Piping Connections	Liquid Pipe	Type	-	Flare connection	Flare connection	Flare connection
		Φ,mm	-	9.52	9.52	9.52
		Φ, inch	-	3/8"	3/8"	3/8"
	Gas Pipe	Type	-	Flare connection	Flare connection	Flare connection
		Φ,mm	-	15.88	15.88	15.88
		Φ, inch	-	5/8"	5/8"	5/8"
	Heat insulation		-	Both liquid and gas pipes	Both liquid and gas pipes	Both liquid and gas pipes
Drain Pipe		Φ,mm	VP25 (OD 32,ID 25)	VP25 (OD 32,ID 25)	VP25 (OD 32,ID 25)	
Wiring connections	For power supply	Minimum	mm2	1.5	1.5	1.5
	For connection with indoor	Minimum	mm2	0.75	0.75	0.75
		Remark	-	-	F1,F2	F1,F2
Refrigerant	Type		-	R410A	R410A	R410A
	Control Method		-	EEV Included	EEV Included	EEV Included
Sound	Sound Pressure	High / Mid / Low	dB(A)	39/36/33	40/37/33	38/35/32
	Sound Power	Cooling (Nominal)	dB(A)	46	47	46
Dimensions	Net Weight		kg	38	38	46.5
	Shipping Weight		kg	43.5	43.5	52.5
	Net Dimensions (W×H×D)		mm	1300 x 300 x 700	1300 x 300 x 700	1300 x 300 x 700
	Shipping Dimensions (W×H×D)		mm	1529 x 370 x 779	1529 x 370 x 779	1529 x 370 x 779
Air filter	Type		-	Removable / Washable / Mildew proof	Removable / Washable / Mildew proof	Removable / Washable / Mildew proof
Additional Accessories	Drain pump	Drain pump	Model	MDP-G075SQ(built-in) MDP-G075SP(external)	MDP-G075SQ(built-in) MDP-G075SP(external)	MDP-G075SQ(built-in) MDP-G075SP(external)
		Max. lifting Height	mm	750	750	750

NOTE

- Mode : HP(Heat Pump), HR(Heat Recovery)
- Nominal Cooling : Indoor temperature 27°CDB / 19°CWB, Outdoor temperature 35°CDB/24°CWB, Refrigerant pipe length 7.5m, Level difference 0m.
- Nominal Heating : Indoor temperature 20°CDB / 15°CWB, Outdoor temperature 7°CDB / 6°CWB, Refrigerant pipe length 7.5m, Level difference 0m.
- Sound pressure level was acquired in an anechoic room. Thus actual noise level may be different depending on the installation conditions.
- These products contain R410A which is fluorinated greenhouse gas.
- Specifications may be subject to change without prior notice.
- Select wire size based on the value of MCA

1. Specification

Duct S

Model CODE				AM128HNHPKH/EU	AM140HNHPKH/EU
Power Supply			Φ, #, V, Hz	1,2,220-240,50	1,2,220-240,50
Mode			-	HP/HR	HP/HR
Performance	Capacity (Nominal)	Cooling (ISO/SASO)	kW	12.8	14
			Btu/h	43,700	47,800
		Heating	kW	13.8	16.0
			Btu/h	47,100	54,600
Power	Power Input (Nominal)	Cooling	W	230	260
		Heating	W	230	260
	Current Input (Nominal)	Cooling	A	1.4	1.5
		Heating	A	1.4	1.5
	Current	MCA	A	3.17	3.42
		MFA/MOP	A	15	15
Heat exchanger	Type		-	FME	FME
	Material	Fin	-	Al	Al
		Tube	-	Al	Al
	Fin Treatment		-	Anti-corrosion	Anti-corrosion
Fan	Type		-	Sirocco Fan	Sirocco Fan
	Quantity		EA	3	3
	Air Flow Rate	H/M/L (UL)	m ³ /min	38.0 / 32.0 / 25.0	42.0 / 34.0 / 25.0
			l/s	633 / 533 / 417	700 / 567 / 417
	External Pressure	Min / Std / Max	mmAq	3 / 6.2 / 20	3 / 6.2 / 20
			Pa	0 / 60.8 / 196.2	0 / 60.8 / 196.2
Fan Motor	Model		-	BLDC motor(feedback)	BLDC motor(feedback)
	Output x n		W	350 x 1	350 x 1
Piping Connections	Liquid Pipe		Type	Flare connection	Flare connection
			Φ,mm	9.52	9.52
			Φ, inch	3/8"	3/8"
	Gas Pipe		Type	Flare connection	Flare connection
			Φ,mm	15.88	15.88
			Φ, inch	5/8"	5/8"
	Heat insulation		-	Both liquid and gas pipes	Both liquid and gas pipes
Drain Pipe		Φ,mm	VP25 (OD 32,ID 25)	VP25 (OD 32,ID 25)	
Wiring connections	For power supply	Minimum	mm ²	1.5	1.5
	For connection with indoor	Minimum	mm ²	0.75	0.75
		Remark	-	-	F1,F2
Refrigerant	Type		-	R410A	R410A
	Control Method		-	EEV Included	EEV Included
Sound	Sound Pressure	High / Mid / Low	dB(A)	39/36/33	40/37/34
	Sound Power	Cooling (Nominal)		47	49
Dimensions	Net Weight		kg	46.5	46.5
	Shipping Weight		kg	52.5	52.5
	Net Dimensions (W×H×D)		mm	1300 x 300 x 700	1300 x 300 x 700
	Shipping Dimensions (W×H×D)		mm	1529 x 370 x 779	1529 x 370 x 779
Air filter	Type		-	Removable / Washable / Mildew proof	Removable / Washable / Mildew proof
Additional Accessories	Drain pump	Drain pump	Model	MDP-G075SQ(built-in) MDP-G075SP(external)	MDP-G075SQ(built-in) MDP-G075SP(external)
		Max. lifting Height	mm	750	750

NOTE

- Mode : HP(Heat Pump), HR(Heat Recovery)
- Nominal Cooling : Indoor temperature 27°CDB / 19°CWB, Outdoor temperature 35°CDB/24°CWB, Refrigerant pipe length 7.5m, Level difference 0m.
- Nominal Heating : Indoor temperature 20°CDB / 15°CWB, Outdoor temperature 7°CDB / 6°CWB, Refrigerant pipe length 7.5m, Level difference 0m.
- Sound pressure level was acquired in an anechoic room. Thus actual noise level may be different depending on the installation conditions.
- These products contain R410A which is fluorinated greenhouse gas.
- Specifications may be subject to change without prior notice.
- Select wire size based on the value of MCA

2. Summary Table

Performance Characteristics

Model Code	Fan Speed	Nominal Capacity			Airflow (CMM)	Sound Pressure (dBA)	Sound Power (dBA)	Static Pressure (Min/Std/Max) (Pa)
		Cooling (kW)	Sensible (Kw)	Heating (kW)				
AM036HNMPKH/EU	High	3.6	2.6	4.0	12.0	29	40	0 / 2.5 / 15
	Mid	2.5	2.3	3.6	9.5	26	-	
	Low	2.1	1.9	3.3	8.0	23	-	
AM045HNMPKH/EU	High	4.5	3.3	5.0	14.0	31	44	0 / 3 / 15
	Mid	3.0	2.8	4.4	11.0	28	-	
	Low	2.5	2.3	3.8	8.0	24	-	
AM056HNMPKH/EU	High	5.6	4.2	6.3	16.0	32	45	0 / 3 / 15
	Mid	3.8	3.3	5.8	13.5	29	-	
	Low	3.2	2.9	5.2	11.0	25	-	
AM071HNMPKH/EU	High	7.1	5.4	8.0	22.0	37	47	0 / 3 / 15
	Mid	4.9	4.3	7.4	19.0	33	-	
	Low	4.0	3.7	6.8	16.0	29	-	
AM090HNMPKH/EU	High	9.0	7.1	10.0	29.0	38	44	0 / 4 / 15
	Mid	6.1	5.4	9.3	25.0	35	-	
	Low	5.0	4.6	8.7	22.0	32	-	
AM112HNMPKH/EU	High	11.2	8.6	12.5	35.0	38	45	0 / 5.2 / 15
	Mid	7.4	6.5	11.4	29.0	35	-	
	Low	6.0	5.5	9.9	22.0	32	-	
AM128HNMPKH/EU	High	12.8	9.9	13.8	38.0	39	46	0 / 5.2 / 15
	Mid	8.5	7.5	12.7	32.0	36	-	
	Low	6.8	6.3	11.2	25.0	33	-	
AM140HNMPKH/EU	High	14.0	10.8	16.0	42.0	40	47	0 / 5.2 / 15
	Mid	9.1	7.9	14.4	34.0	37	-	
	Low	7.3	6.7	12.3	25.0	33	-	
AM112HNHPKH/EU	High	11.2	8.6	12.5	35.0	38	46	0 / 6.2 / 20
	Mid	7.4	6.5	11.4	29.0	35	-	
	Low	6.0	5.5	9.9	22.0	32	-	
AM128HNHPKH/EU	High	12.8	9.9	13.8	38.0	39	47	0 / 6.2 / 20
	Mid	8.5	7.5	12.7	32.0	36	-	
	Low	6.8	6.3	11.2	25.0	33	-	
AM140HNHPKH/EU	High	14.0	10.8	16.0	42.0	40	49	0 / 6.2 / 20
	Mid	9.1	7.9	14.4	34.0	37	-	
	Low	7.3	6.7	12.3	25.0	34	-	

Electrical Characteristics

Model Code	Power Supply (Ø, #, V, Hz)	Power Input (W)	Current Input (A)	MCA (A)	MFA (A)	FLA (A)
AM036HNMPKH/EU	1, 2, 220-240, 50	50.0	0.50	1.04	15	0.83
AM045HNMPKH/EU	1, 2, 220-240, 50	60.0	0.60	1.26	15	1.01
AM056HNMPKH/EU	1, 2, 220-240, 50	70.0	0.70	1.26	15	1.01
AM071HNMPKH/EU	1, 2, 220-240, 50	120.0	1.00	1.52	15	1.21
AM090HNMPKH/EU	1, 2, 220-240, 50	145.0	1.20	2.03	15	1.63
AM112HNMPKH/EU	1, 2, 220-240, 50	165.0	1.40	2.51	15	2.01
AM128HNMPKH/EU	1, 2, 220-240, 50	175.0	1.50	2.51	15	2.01
AM140HNMPKH/EU	1, 2, 220-240, 50	215.0	1.70	2.51	15	2.01
AM112HNHPKH/EU	1, 2, 220-240, 50	205.0	1.20	2.92	15	2.34
AM128HNHPKH/EU	1, 2, 220-240, 50	230.0	1.40	3.17	15	2.54
AM140HNHPKH/EU	1, 2, 220-240, 50	260.0	1.50	3.42	15	2.73

NOTE

- MCA : Minimum circuit amperes
- FLA : Full load amperes.

3. Capacity Table

Duct S (AM***HNMPKH/EU)

Cooling

TC: Total Capacity, SHC: Sensible Heat Capacity

Capacity Index	Outdoor Air Temp. (°C, DB)	Indoor temperature													
		20(°C, DB)		23(°C, DB)		26(°C, DB)		27(°C, DB)		28(°C, DB)		30(°C, DB)		32(°C, DB)	
		14(°C, WB)		16(°C, WB)		18(°C, WB)		19(°C, WB)		20(°C, WB)		22(°C, WB)		24(°C, WB)	
		TC	SHC	TC	SHC	TC	SHC	TC	SHC	TC	SHC	TC	SHC	TC	SHC
036	10	2.5	2.0	2.9	2.3	3.4	2.5	3.6	2.6	3.7	2.6	4.0	2.6	4.3	2.5
	12	2.5	2.0	2.9	2.3	3.4	2.5	3.6	2.6	3.7	2.6	4.0	2.6	4.3	2.5
	14	2.5	2.0	2.9	2.3	3.4	2.5	3.6	2.6	3.7	2.6	4.0	2.6	4.3	2.5
	16	2.5	2.0	2.9	2.3	3.4	2.5	3.6	2.6	3.7	2.6	4.0	2.6	4.3	2.5
	18	2.5	2.0	2.9	2.3	3.4	2.5	3.6	2.6	3.7	2.6	4.0	2.6	4.2	2.4
	20	2.5	2.0	2.9	2.3	3.4	2.5	3.6	2.6	3.7	2.6	4.0	2.6	4.2	2.4
	21	2.5	2.0	2.9	2.3	3.4	2.5	3.6	2.6	3.7	2.6	4.0	2.6	4.2	2.4
	23	2.5	2.0	2.9	2.3	3.4	2.5	3.6	2.6	3.7	2.6	4.0	2.6	4.2	2.4
	25	2.5	2.0	2.9	2.3	3.4	2.5	3.6	2.6	3.7	2.6	4.0	2.6	4.2	2.4
	27	2.5	2.0	2.9	2.3	3.4	2.5	3.6	2.6	3.7	2.6	4.0	2.6	4.2	2.4
	29	2.5	2.0	2.9	2.3	3.4	2.5	3.6	2.6	3.7	2.6	4.0	2.6	4.2	2.4
	31	2.5	2.0	2.9	2.3	3.4	2.5	3.6	2.6	3.7	2.6	4.0	2.6	4.2	2.4
	33	2.5	2.0	2.9	2.3	3.4	2.5	3.6	2.6	3.7	2.6	4.0	2.6	4.2	2.4
	35	2.5	2.0	2.9	2.3	3.4	2.5	3.6	2.6	3.7	2.6	4.0	2.6	4.2	2.4
	37	2.5	2.0	2.9	2.3	3.4	2.5	3.6	2.6	3.7	2.6	3.9	2.5	4.2	2.4
39	2.5	2.0	2.9	2.3	3.4	2.5	3.6	2.6	3.7	2.6	3.9	2.5	4.1	2.3	
42	2.5	2.0	2.9	2.3	3.4	2.5	3.6	2.6	3.7	2.6	3.8	2.5	4.0	2.2	
44	2.5	2.0	2.9	2.3	3.3	2.4	3.4	2.5	3.6	2.5	3.7	2.4	3.9	2.2	
46	2.5	2.0	2.9	2.3	3.2	2.4	3.3	2.4	3.4	2.4	3.6	2.3	3.8	2.1	
48	2.5	2.0	2.8	2.2	3.2	2.3	3.2	2.3	3.4	2.4	3.5	2.2	3.6	2.0	
045	10	3.1	2.7	3.7	3.1	4.2	3.2	4.5	3.3	4.7	3.3	5.0	3.3	5.4	3.4
	12	3.1	2.7	3.7	3.1	4.2	3.2	4.5	3.3	4.7	3.3	5.0	3.3	5.4	3.4
	14	3.1	2.7	3.7	3.1	4.2	3.2	4.5	3.3	4.7	3.3	5.0	3.3	5.4	3.4
	16	3.1	2.7	3.7	3.1	4.2	3.2	4.5	3.3	4.7	3.3	5.0	3.3	5.3	3.1
	18	3.1	2.7	3.7	3.1	4.2	3.2	4.5	3.3	4.7	3.3	5.0	3.3	5.3	3.1
	20	3.1	2.7	3.7	3.1	4.2	3.2	4.5	3.3	4.7	3.3	5.0	3.3	5.3	3.1
	21	3.1	2.7	3.7	3.1	4.2	3.2	4.5	3.3	4.7	3.3	5.0	3.3	5.3	3.1
	23	3.1	2.7	3.7	3.1	4.2	3.2	4.5	3.3	4.7	3.3	5.0	3.3	5.3	3.1
	25	3.1	2.7	3.7	3.1	4.2	3.2	4.5	3.3	4.7	3.3	5.0	3.3	5.3	3.1
	27	3.1	2.7	3.7	3.1	4.2	3.2	4.5	3.3	4.7	3.3	5.0	3.3	5.3	3.1
	29	3.1	2.7	3.7	3.1	4.2	3.2	4.5	3.3	4.7	3.3	5.0	3.3	5.3	3.1
	31	3.1	2.7	3.7	3.1	4.2	3.2	4.5	3.3	4.7	3.3	5.0	3.3	5.3	3.1
	33	3.1	2.7	3.7	3.1	4.2	3.2	4.5	3.3	4.7	3.3	5.0	3.3	5.3	3.1
	35	3.1	2.7	3.7	3.1	4.2	3.2	4.5	3.3	4.7	3.3	5.0	3.3	5.3	3.1
	37	3.1	2.7	3.7	3.1	4.2	3.2	4.5	3.3	4.6	3.2	4.9	3.2	5.2	3.1
39	3.1	2.7	3.7	3.1	4.2	3.2	4.5	3.3	4.6	3.2	4.9	3.2	5.1	3.0	
42	3.1	2.7	3.7	3.1	4.2	3.2	4.4	3.3	4.5	3.2	4.8	3.1	5.0	2.9	
44	3.1	2.7	3.7	3.1	4.1	3.1	4.3	3.2	4.4	3.1	4.6	3.0	4.8	2.8	
46	3.1	2.7	3.7	3.1	4.0	3.0	4.2	3.1	4.3	3.0	4.5	2.9	4.7	2.7	
48	3.1	2.6	3.6	3.0	3.9	3.0	4.0	3.0	4.2	2.9	4.3	2.8	4.5	2.6	
056	10	3.9	3.3	4.6	3.8	5.3	4.0	5.6	4.2	5.8	4.2	6.3	4.3	6.7	4.1
	12	3.9	3.3	4.6	3.8	5.3	4.0	5.6	4.2	5.8	4.2	6.3	4.3	6.7	4.1
	14	3.9	3.3	4.6	3.8	5.3	4.0	5.6	4.2	5.8	4.2	6.2	4.2	6.7	4.1
	16	3.9	3.3	4.6	3.8	5.3	4.0	5.6	4.2	5.8	4.2	6.2	4.2	6.6	4.0
	18	3.9	3.3	4.6	3.8	5.3	4.0	5.6	4.2	5.8	4.2	6.2	4.2	6.6	4.0
	20	3.9	3.3	4.6	3.8	5.3	4.0	5.6	4.2	5.8	4.2	6.2	4.2	6.6	4.0
	21	3.9	3.3	4.6	3.8	5.3	4.0	5.6	4.2	5.8	4.2	6.2	4.2	6.6	4.0
	23	3.9	3.3	4.6	3.8	5.3	4.0	5.6	4.2	5.8	4.2	6.2	4.2	6.6	4.0
	25	3.9	3.3	4.6	3.8	5.3	4.0	5.6	4.2	5.8	4.2	6.2	4.2	6.6	4.0
	27	3.9	3.3	4.6	3.8	5.3	4.0	5.6	4.2	5.8	4.2	6.2	4.2	6.6	4.0
	29	3.9	3.3	4.6	3.8	5.3	4.0	5.6	4.2	5.8	4.2	6.2	4.2	6.6	4.0
	31	3.9	3.3	4.6	3.8	5.3	4.0	5.6	4.2	5.8	4.2	6.2	4.2	6.6	4.0
	33	3.9	3.3	4.6	3.8	5.3	4.0	5.6	4.2	5.8	4.2	6.2	4.2	6.6	4.0
	35	3.9	3.3	4.6	3.8	5.3	4.0	5.6	4.2	5.8	4.2	6.2	4.2	6.6	4.0
	37	3.9	3.3	4.6	3.8	5.3	4.0	5.6	4.2	5.8	4.2	6.1	4.1	6.5	3.9
39	3.9	3.3	4.6	3.8	5.3	4.0	5.6	4.2	5.8	4.2	6.1	4.1	6.4	3.8	
42	3.9	3.3	4.6	3.8	5.3	4.0	5.5	4.1	5.7	4.2	6.0	4.0	6.2	3.7	
44	3.9	3.3	4.6	3.8	5.1	3.9	5.3	4.0	5.6	4.0	5.8	3.9	6.0	3.6	
46	3.9	3.3	4.6	3.7	5.0	3.8	5.2	3.9	5.4	3.9	5.6	3.7	5.9	3.5	
48	3.9	3.2	4.5	3.7	5.0	3.7	5.0	3.8	5.3	3.8	5.4	3.6	5.7	3.3	

3. Capacity Table

Duct S (AM***HNMPKH/EU)

Cooling

TC: Total Capacity, SHC: Sensible Heat Capacity

Capacity Index	Outdoor Air Temp. (°C, DB)	Indoor temperature													
		20(°C, DB)		23(°C, DB)		26(°C, DB)		27(°C, DB)		28(°C, DB)		30(°C, DB)		32(°C, DB)	
		14(°C, WB)		16(°C, WB)		18(°C, WB)		19(°C, WB)		20(°C, WB)		22(°C, WB)		24(°C, WB)	
		TC	SHC	TC	SHC	TC	SHC	TC	SHC	TC	SHC	TC	SHC	TC	SHC
071	10	4.9	4.3	5.8	5.0	6.7	5.2	7.1	5.4	7.4	5.6	8.0	5.7	8.5	5.4
	12	4.9	4.3	5.8	5.0	6.7	5.2	7.1	5.4	7.4	5.6	7.9	5.6	8.5	5.4
	14	4.9	4.3	5.8	5.0	6.7	5.2	7.1	5.4	7.4	5.6	7.9	5.6	8.5	5.4
	16	4.9	4.3	5.8	5.0	6.7	5.2	7.1	5.4	7.4	5.6	7.9	5.6	8.4	5.3
	18	4.9	4.3	5.8	5.0	6.7	5.2	7.1	5.4	7.4	5.6	7.9	5.6	8.4	5.3
	20	4.9	4.3	5.8	5.0	6.7	5.2	7.1	5.4	7.4	5.6	7.9	5.6	8.4	5.3
	21	4.9	4.3	5.8	5.0	6.7	5.2	7.1	5.4	7.4	5.6	7.9	5.6	8.4	5.3
	23	4.9	4.3	5.8	5.0	6.7	5.2	7.1	5.4	7.4	5.6	7.9	5.6	8.4	5.3
	25	4.9	4.3	5.8	5.0	6.7	5.2	7.1	5.4	7.4	5.6	7.9	5.6	8.4	5.3
	27	4.9	4.3	5.8	5.0	6.7	5.2	7.1	5.4	7.4	5.6	7.9	5.6	8.4	5.3
	29	4.9	4.3	5.8	5.0	6.7	5.2	7.1	5.4	7.4	5.6	7.9	5.6	8.4	5.3
	31	4.9	4.3	5.8	5.0	6.7	5.2	7.1	5.4	7.4	5.6	7.9	5.6	8.4	5.3
	33	4.9	4.3	5.8	5.0	6.7	5.2	7.1	5.4	7.4	5.6	7.9	5.6	8.4	5.3
	35	4.9	4.3	5.8	5.0	6.7	5.2	7.1	5.4	7.4	5.6	7.9	5.6	8.4	5.3
	37	4.9	4.3	5.8	5.0	6.7	5.2	7.1	5.4	7.3	5.5	7.8	5.5	8.2	5.2
39	4.9	4.3	5.8	5.0	6.7	5.2	7.1	5.4	7.3	5.5	7.7	5.4	8.1	5.1	
42	4.9	4.3	5.8	5.0	6.7	5.2	7.0	5.3	7.2	5.4	7.6	5.3	7.9	5.0	
44	4.9	4.3	5.8	5.0	6.5	5.0	6.8	5.2	7.0	5.3	7.3	5.1	7.6	4.8	
46	4.9	4.3	5.7	5.0	6.4	4.9	6.6	5.0	6.8	5.1	7.0	4.9	7.4	4.7	
48	4.8	4.2	5.7	4.9	6.3	4.9	6.4	4.9	6.7	5.0	6.8	4.8	7.2	4.5	
090	10	6.2	5.7	7.3	6.5	8.4	6.9	9.0	7.1	9.4	7.3	10.1	7.3	10.8	7.3
	12	6.2	5.7	7.3	6.5	8.4	6.9	9.0	7.1	9.4	7.3	10.1	7.3	10.8	7.3
	14	6.2	5.7	7.3	6.5	8.4	6.9	9.0	7.1	9.3	7.2	10.0	7.2	10.7	7.1
	16	6.2	5.7	7.3	6.5	8.4	6.9	9.0	7.1	9.3	7.2	10.0	7.2	10.7	7.1
	18	6.2	5.7	7.3	6.5	8.4	6.9	9.0	7.1	9.3	7.2	10.0	7.2	10.6	7.0
	20	6.2	5.7	7.3	6.5	8.4	6.9	9.0	7.1	9.3	7.2	10.0	7.2	10.6	7.0
	21	6.2	5.7	7.3	6.5	8.4	6.9	9.0	7.1	9.3	7.2	10.0	7.2	10.6	7.0
	23	6.2	5.7	7.3	6.5	8.4	6.9	9.0	7.1	9.3	7.2	10.0	7.2	10.6	7.0
	25	6.2	5.7	7.3	6.5	8.4	6.9	9.0	7.1	9.3	7.2	10.0	7.2	10.6	7.0
	27	6.2	5.7	7.3	6.5	8.4	6.9	9.0	7.1	9.3	7.2	10.0	7.2	10.6	7.0
	29	6.2	5.7	7.3	6.5	8.4	6.9	9.0	7.1	9.3	7.2	10.0	7.2	10.6	7.0
	31	6.2	5.7	7.3	6.5	8.4	6.9	9.0	7.1	9.3	7.2	10.0	7.2	10.6	7.0
	33	6.2	5.7	7.3	6.5	8.4	6.9	9.0	7.1	9.3	7.2	10.0	7.2	10.6	7.0
	35	6.2	5.7	7.3	6.5	8.4	6.9	9.0	7.1	9.3	7.2	10.0	7.2	10.6	7.0
	37	6.2	5.7	7.3	6.5	8.4	6.9	9.0	7.1	9.3	7.2	9.9	7.1	10.4	6.9
39	6.2	5.7	7.3	6.5	8.4	6.9	9.0	7.1	9.2	7.1	9.7	7.0	10.2	6.8	
42	6.2	5.7	7.3	6.5	8.3	6.8	8.9	7.0	9.1	7.0	9.5	6.9	9.9	6.6	
44	6.2	5.7	7.3	6.5	8.1	6.7	8.6	6.8	8.8	6.8	9.2	6.6	9.6	6.4	
46	6.2	5.7	7.2	6.4	8.0	6.6	8.3	6.6	8.6	6.6	8.9	6.4	9.3	6.2	
48	6.1	5.6	7.1	6.3	7.8	6.4	8.1	6.4	8.4	6.5	8.6	6.2	9.0	6.0	
112	10	7.7	6.8	9.1	7.7	10.5	8.2	11.2	8.6	11.6	8.8	12.5	8.9	13.4	8.6
	12	7.7	6.8	9.1	7.7	10.5	8.2	11.2	8.6	11.6	8.8	12.5	8.9	13.4	8.6
	14	7.7	6.8	9.1	7.7	10.5	8.2	11.2	8.6	11.6	8.8	12.5	8.9	13.4	8.6
	16	7.7	6.8	9.1	7.7	10.5	8.2	11.2	8.6	11.6	8.8	12.5	8.9	13.3	8.5
	18	7.7	6.8	9.1	7.7	10.5	8.2	11.2	8.6	11.6	8.8	12.5	8.9	13.3	8.5
	20	7.7	6.8	9.1	7.7	10.5	8.2	11.2	8.6	11.6	8.8	12.4	8.8	13.2	8.5
	21	7.7	6.8	9.1	7.7	10.5	8.2	11.2	8.6	11.6	8.8	12.4	8.8	13.2	8.5
	23	7.7	6.8	9.1	7.7	10.5	8.2	11.2	8.6	11.6	8.8	12.4	8.8	13.2	8.5
	25	7.7	6.8	9.1	7.7	10.5	8.2	11.2	8.6	11.6	8.8	12.4	8.8	13.2	8.5
	27	7.7	6.8	9.1	7.7	10.5	8.2	11.2	8.6	11.6	8.8	12.4	8.8	13.2	8.5
	29	7.7	6.8	9.1	7.7	10.5	8.2	11.2	8.6	11.6	8.8	12.4	8.8	13.2	8.5
	31	7.7	6.8	9.1	7.7	10.5	8.2	11.2	8.6	11.6	8.8	12.4	8.8	13.2	8.5
	33	7.7	6.8	9.1	7.7	10.5	8.2	11.2	8.6	11.6	8.8	12.4	8.8	13.2	8.5
	35	7.7	6.8	9.1	7.7	10.5	8.2	11.2	8.6	11.6	8.8	12.4	8.7	13.2	8.5
	37	7.7	6.8	9.1	7.7	10.5	8.2	11.2	8.6	11.6	8.8	12.4	8.9	13.2	8.5
39	7.7	6.8	9.1	7.7	10.5	8.2	11.2	8.6	11.6	8.8	12.3	8.8	13.0	8.4	
42	7.7	6.8	9.1	7.7	10.4	8.1	11.1	8.5	11.5	8.7	12.1	8.6	12.7	8.2	
44	7.7	6.8	9.1	7.7	10.1	7.9	10.7	8.2	11.1	8.4	11.6	8.3	12.2	7.9	
46	7.7	6.8	9.0	7.6	10.0	7.8	10.4	8.0	10.8	8.2	11.2	8.0	11.9	7.7	
48	7.6	6.7	8.9	7.5	9.8	7.7	10.1	7.7	10.6	8.0	10.9	7.8	11.5	7.4	

3. Capacity Table

Duct S (AM***HNMPKH/EU)

Cooling

TC: Total Capacity, SHC: Sensible Heat Capacity

Capacity Index	Outdoor Air Temp. (°C,DB)	Indoor temperature													
		20(°C,DB)		23(°C,DB)		26(°C,DB)		27(°C,DB)		28(°C,DB)		30(°C,DB)		32(°C,DB)	
		14(°C,WB)		16(°C,WB)		18(°C,WB)		19(°C,WB)		20(°C,WB)		22(°C,WB)		24(°C,WB)	
		TC	SHC	TC	SHC	TC	SHC	TC	SHC	TC	SHC	TC	SHC	TC	SHC
128	10	8.8	7.8	10.4	8.9	12.0	9.5	12.8	9.9	13.3	9.9	14.3	10.0	15.4	9.9
	12	8.8	7.8	10.4	8.9	12.0	9.5	12.8	9.9	13.3	9.9	14.3	10.0	15.3	9.8
	14	8.8	7.8	10.4	8.9	12.0	9.5	12.8	9.9	13.3	9.9	14.3	10.0	15.3	9.8
	16	8.8	7.8	10.4	8.9	12.0	9.5	12.8	9.9	13.3	9.9	14.2	9.9	15.2	9.8
	18	8.8	7.8	10.4	8.9	12.0	9.5	12.8	9.9	13.3	9.9	14.2	9.9	15.1	9.7
	20	8.8	7.8	10.4	8.9	12.0	9.5	12.8	9.9	13.3	9.9	14.2	9.9	15.1	9.7
	21	8.8	7.8	10.4	8.9	12.0	9.5	12.8	9.9	13.3	9.9	14.2	9.9	15.1	9.7
	23	8.8	7.8	10.4	8.9	12.0	9.5	12.8	9.9	13.3	9.9	14.2	9.9	15.1	9.7
	25	8.8	7.8	10.4	8.9	12.0	9.5	12.8	9.9	13.3	9.9	14.2	9.9	15.1	9.7
	27	8.8	7.8	10.4	8.9	12.0	9.5	12.8	9.9	13.3	9.9	14.2	9.9	15.1	9.7
	29	8.8	7.8	10.4	8.9	12.0	9.5	12.8	9.9	13.3	9.9	14.2	9.9	15.1	9.7
	31	8.8	7.8	10.4	8.9	12.0	9.5	12.8	9.9	13.3	9.9	14.2	9.9	15.1	9.7
	33	8.8	7.8	10.4	8.9	12.0	9.5	12.8	9.9	13.3	9.9	14.2	9.9	15.1	9.7
	35	8.8	7.8	10.4	8.9	12.0	9.5	12.8	9.9	13.3	9.9	14.2	9.9	15.1	9.7
	37	8.8	7.8	10.4	8.9	12.0	9.5	12.8	9.9	13.2	9.9	14.0	9.8	14.9	9.6
	39	8.8	7.8	10.4	8.9	12.0	9.5	12.8	9.9	13.1	9.8	13.8	9.6	14.5	9.4
42	8.8	7.8	10.4	8.9	11.9	9.4	12.6	9.8	12.9	9.7	13.6	9.4	14.1	9.2	
44	8.8	7.8	10.4	8.9	11.6	9.2	12.2	9.5	12.6	9.4	13.0	9.1	13.6	8.8	
46	8.8	7.8	10.3	8.8	11.4	9.0	11.8	9.2	12.2	9.1	12.6	8.8	13.3	8.6	
48	8.7	7.7	10.2	8.7	11.2	8.9	11.5	8.9	12.0	8.9	12.2	8.5	12.8	8.3	
140	10	9.7	8.6	11.4	9.7	13.1	10.5	14.0	10.8	14.6	10.9	15.7	11.0	16.8	10.9
	12	9.7	8.6	11.4	9.7	13.1	10.5	14.0	10.8	14.5	10.8	15.6	10.9	16.7	10.8
	14	9.7	8.6	11.4	9.7	13.1	10.5	14.0	10.8	14.5	10.8	15.6	10.9	16.7	10.8
	16	9.7	8.6	11.4	9.7	13.1	10.5	14.0	10.8	14.5	10.8	15.6	10.9	16.6	10.7
	18	9.7	8.6	11.4	9.7	13.1	10.5	14.0	10.8	14.5	10.8	15.5	10.8	16.6	10.7
	20	9.7	8.6	11.4	9.7	13.1	10.5	14.0	10.8	14.5	10.8	15.5	10.8	16.5	10.6
	21	9.7	8.6	11.4	9.7	13.1	10.5	14.0	10.8	14.5	10.8	15.5	10.8	16.5	10.6
	23	9.7	8.6	11.4	9.7	13.1	10.5	14.0	10.8	14.5	10.8	15.5	10.8	16.5	10.6
	25	9.7	8.6	11.4	9.7	13.1	10.5	14.0	10.8	14.5	10.8	15.5	10.8	16.5	10.6
	27	9.7	8.6	11.4	9.7	13.1	10.5	14.0	10.8	14.5	10.8	15.5	10.8	16.5	10.6
	29	9.7	8.6	11.4	9.7	13.1	10.5	14.0	10.8	14.5	10.8	15.5	10.8	16.5	10.6
	31	9.7	8.6	11.4	9.7	13.1	10.5	14.0	10.8	14.5	10.8	15.5	10.8	16.5	10.6
	33	9.7	8.6	11.4	9.7	13.1	10.5	14.0	10.8	14.5	10.8	15.5	10.8	16.5	10.6
	35	9.7	8.6	11.4	9.7	13.1	10.5	14.0	10.8	14.5	10.8	15.5	10.8	16.5	10.6
	37	9.7	8.6	11.4	9.7	13.1	10.5	14.0	10.8	14.5	10.8	15.4	10.7	16.3	10.5
	39	9.7	8.6	11.4	9.7	13.1	10.5	14.0	10.8	14.4	10.7	15.1	10.5	15.9	10.3
42	9.7	8.6	11.4	9.7	13.0	10.4	13.8	10.7	14.2	10.6	14.8	10.3	15.5	10.0	
44	9.7	8.6	11.4	9.7	12.7	10.1	13.4	10.3	13.8	10.3	14.2	9.9	15.0	9.7	
46	9.7	8.6	11.3	9.6	12.4	10.0	12.9	10.0	13.4	10.0	13.8	9.6	14.6	9.4	
48	9.6	8.5	11.1	9.5	12.2	9.8	12.6	9.7	13.1	9.8	13.4	9.3	14.1	9.1	

3. Capacity Table

Duct S (AM***HNMPKH/EU)

Heating

TC: Total Capacity

Capacity Index	Outdoor Air Temp. (°C)		Indoor temperature (°C,DB)				
			16(°C,DB)	18(°C,DB)	20(°C,DB)	22(°C,DB)	24(°C,DB)
	DB	WB	TC kW	TC kW	TC kW	TC kW	TC kW
036	-19.8	-20.0	2.4	2.4	2.3	2.3	2.3
	-18.8	-19.0	2.5	2.4	2.3	2.3	2.3
	-16.7	-17.0	2.6	2.5	2.4	2.4	2.3
	-14.7	-15.0	2.7	2.6	2.5	2.5	2.4
	-12.6	-13.0	2.8	2.7	2.7	2.6	2.6
	-10.5	-11.0	2.9	2.9	2.9	2.8	2.8
	-9.5	-10.0	2.9	2.9	2.9	2.8	2.8
	-8.5	-9.1	3.0	3.0	3.0	2.9	2.9
	-7.0	-7.6	3.1	3.1	3.0	3.0	2.9
	-5.0	-5.6	3.3	3.2	3.2	3.1	3.0
	-3.0	-3.7	3.4	3.4	3.3	3.2	3.1
	0.0	-0.7	3.6	3.6	3.5	3.4	3.2
	3.0	2.2	3.8	3.7	3.7	3.5	3.4
	5.0	4.1	3.9	3.9	3.8	3.6	3.4
	7.0	6.0	4.1	4.1	4.0	3.7	3.4
9.0	7.9	4.2	4.1	4.0	3.7	3.4	
11.0	9.8	4.4	4.2	4.0	3.7	3.4	
13.0	11.8	4.5	4.2	4.0	3.7	3.4	
15.0	13.7	4.6	4.3	4.0	3.7	3.4	
045	-19.8	-20.0	3.1	3.1	2.9	2.9	2.9
	-18.8	-19.0	3.1	3.1	3.0	2.9	2.9
	-16.7	-17.0	3.2	3.2	3.1	3.0	3.0
	-14.7	-15.0	3.3	3.3	3.2	3.1	3.0
	-12.6	-13.0	3.5	3.4	3.4	3.3	3.2
	-10.5	-11.0	3.7	3.6	3.6	3.5	3.4
	-9.5	-10.0	3.7	3.6	3.6	3.5	3.5
	-8.5	-9.1	3.8	3.7	3.7	3.6	3.6
	-7.0	-7.6	3.9	3.8	3.8	3.7	3.6
	-5.0	-5.6	4.1	4.0	4.0	3.9	3.7
	-3.0	-3.7	4.3	4.2	4.2	4.0	3.9
	0.0	-0.7	4.5	4.4	4.4	4.2	4.0
	3.0	2.2	4.7	4.7	4.6	4.4	4.2
	5.0	4.1	4.9	4.9	4.8	4.5	4.2
	7.0	6.0	5.1	5.1	5.0	4.6	4.2
9.0	7.9	5.3	5.2	5.0	4.6	4.2	
11.0	9.8	5.5	5.2	5.0	4.6	4.2	
13.0	11.8	5.6	5.3	5.0	4.6	4.2	
15.0	13.7	5.8	5.4	5.0	4.6	4.2	
056	-19.8	-20.0	3.9	3.8	3.8	3.7	3.7
	-18.8	-19.0	3.9	3.9	3.8	3.7	3.7
	-16.7	-17.0	4.0	4.0	3.9	3.8	3.8
	-14.7	-15.0	4.2	4.1	4.0	3.9	3.8
	-12.6	-13.0	4.4	4.3	4.2	4.1	4.0
	-10.5	-11.0	4.6	4.5	4.4	4.4	4.3
	-9.5	-10.0	4.7	4.6	4.6	4.5	4.4
	-8.5	-9.1	4.8	4.7	4.7	4.6	4.5
	-7.0	-7.6	4.9	4.8	4.8	4.7	4.5
	-5.0	-5.6	5.2	5.1	5.0	4.9	4.7
	-3.0	-3.7	5.4	5.3	5.3	5.1	4.9
	0.0	-0.7	5.7	5.6	5.5	5.3	5.0
	3.0	2.2	5.9	5.9	5.8	5.6	5.3
	5.0	4.1	6.2	6.1	6.0	5.7	5.3
	7.0	6.0	6.5	6.4	6.3	5.8	5.3
9.0	7.9	6.7	6.5	6.3	5.8	5.3	
11.0	9.8	6.9	6.6	6.3	5.8	5.3	
13.0	11.8	7.1	6.7	6.3	5.8	5.3	
15.0	13.7	7.3	6.8	6.3	5.8	5.3	

3. Capacity Table

Duct S (AM***HNMPKH/EU)

Heating

TC: Total Capacity

Capacity Index	Outdoor Air Temp. (°C)		Indoor temperature (°C,DB)				
			16(°C,DB)	18(°C,DB)	20(°C,DB)	22(°C,DB)	24(°C,DB)
	DB	WB	TC kW	TC kW	TC kW	TC kW	TC kW
071	-19.8	-20.0	4.9	4.9	4.8	4.7	4.7
	-18.8	-19.0	5.0	4.9	4.8	4.7	4.7
	-16.7	-17.0	5.1	5.0	4.9	4.8	4.8
	-14.7	-15.0	5.3	5.2	5.1	4.9	4.8
	-12.6	-13.0	5.5	5.4	5.3	5.2	5.1
	-10.5	-11.0	5.8	5.7	5.6	5.5	5.5
	-9.5	-10.0	6.0	5.9	5.8	5.7	5.6
	-8.5	-9.1	6.1	6.0	5.9	5.8	5.7
	-7.0	-7.6	6.2	6.1	6.0	5.9	5.8
	-5.0	-5.6	6.5	6.5	6.4	6.2	6.0
	-3.0	-3.7	6.9	6.8	6.7	6.4	6.2
	0.0	-0.7	7.2	7.1	7.0	6.7	6.4
	3.0	2.2	7.6	7.5	7.3	7.1	6.8
	5.0	4.1	7.9	7.8	7.7	7.2	6.8
	7.0	6.0	8.2	8.1	8.0	7.4	6.8
9.0	7.9	8.5	8.2	8.0	7.4	6.8	
11.0	9.8	8.7	8.4	8.0	7.4	6.8	
13.0	11.8	9.0	8.5	8.0	7.4	6.8	
15.0	13.7	9.2	8.6	8.0	7.4	6.8	
090	-19.8	-20.0	6.0	6.0	5.9	5.8	5.8
	-18.8	-19.0	6.1	6.1	6.0	5.9	5.8
	-16.7	-17.0	6.4	6.3	6.1	6.0	5.9
	-14.7	-15.0	6.7	6.5	6.3	6.2	6.1
	-12.6	-13.0	6.9	6.8	6.6	6.5	6.4
	-10.5	-11.0	7.2	7.1	7.0	6.9	6.9
	-9.5	-10.0	7.4	7.3	7.2	7.1	7.0
	-8.5	-9.1	7.6	7.5	7.4	7.2	7.1
	-7.0	-7.6	7.8	7.7	7.6	7.4	7.2
	-5.0	-5.6	8.2	8.1	8.0	7.7	7.5
	-3.0	-3.7	8.6	8.5	8.4	8.1	7.7
	0.0	-0.7	9.0	8.9	8.8	8.4	8.0
	3.0	2.2	9.4	9.3	9.2	8.8	8.4
	5.0	4.1	9.9	9.7	9.6	9.0	8.4
	7.0	6.0	10.3	10.1	10.0	9.2	8.4
9.0	7.9	10.6	10.3	10.0	9.2	8.4	
11.0	9.8	10.9	10.5	10.0	9.2	8.4	
13.0	11.8	11.2	10.6	10.0	9.2	8.4	
15.0	13.7	11.6	10.8	10.0	9.2	8.4	
112	-19.8	-20.0	7.4	7.4	7.3	7.3	7.3
	-18.8	-19.0	7.6	7.6	7.4	7.4	7.3
	-16.7	-17.0	8.1	7.8	7.6	7.5	7.4
	-14.7	-15.0	8.4	8.2	8.0	7.8	7.6
	-12.6	-13.0	8.7	8.5	8.3	8.1	8.0
	-10.5	-11.0	9.1	8.9	8.8	8.7	8.6
	-9.5	-10.0	9.3	9.1	9.0	8.9	8.8
	-8.5	-9.1	9.5	9.3	9.2	9.0	8.9
	-7.0	-7.6	9.7	9.6	9.4	9.2	9.0
	-5.0	-5.6	10.2	10.1	9.9	9.6	9.3
	-3.0	-3.7	10.7	10.6	10.5	10.1	9.7
	0.0	-0.7	11.3	11.1	11.1	10.5	10.0
	3.0	2.2	11.8	11.6	11.5	11.0	10.6
	5.0	4.1	12.3	12.2	12.0	11.3	10.6
	7.0	6.0	12.9	12.7	12.5	11.5	10.6
9.0	7.9	13.3	12.9	12.5	11.5	10.6	
11.0	9.8	13.7	13.1	12.5	11.5	10.6	
13.0	11.8	14.0	13.3	12.5	11.5	10.6	
15.0	13.7	14.4	13.5	12.5	11.5	10.6	

3. Capacity Table

Duct S (AM***HNMPKH/EU)

Heating

TC: Total Capacity

Capacity Index	Outdoor Air Temp. (°C)		Indoor temperature (°C,DB)				
			16(°C,DB)	18(°C,DB)	20(°C,DB)	22(°C,DB)	24(°C,DB)
	DB	WB	TC kW	TC kW	TC kW	TC kW	TC kW
128	-19.8	-20.0	8.1	8.1	8.0	8.0	8.0
	-18.8	-19.0	8.3	8.3	8.2	8.1	8.0
	-16.7	-17.0	8.8	8.6	8.4	8.3	8.1
	-14.7	-15.0	9.3	9.1	8.8	8.6	8.3
	-12.6	-13.0	9.6	9.4	9.2	9.0	8.8
	-10.5	-11.0	10.0	9.9	9.8	9.6	9.4
	-9.5	-10.0	10.2	10.1	10.0	9.8	9.7
	-8.5	-9.1	10.4	10.3	10.2	10.0	9.8
	-7.0	-7.6	10.7	10.6	10.4	10.2	10.0
	-5.0	-5.6	11.3	11.1	11.0	10.7	10.3
	-3.0	-3.7	11.9	11.7	11.5	11.1	10.7
	0.0	-0.7	12.4	12.3	12.1	11.6	11.0
	3.0	2.2	13.0	12.9	12.7	12.2	11.7
	5.0	4.1	13.6	13.4	13.2	12.4	11.7
	7.0	6.0	14.2	14.0	13.8	12.7	11.7
9.0	7.9	14.6	14.2	13.8	12.7	11.7	
11.0	9.8	15.1	14.4	13.8	12.7	11.7	
13.0	11.8	15.5	14.7	13.8	12.7	11.7	
15.0	13.7	15.9	14.9	13.8	12.7	11.7	
140	-19.8	-20.0	9.5	9.5	9.4	9.4	9.3
	-18.8	-19.0	9.7	9.7	9.5	9.5	9.3
	-16.7	-17.0	10.2	10.0	9.7	9.6	9.4
	-14.7	-15.0	10.8	10.5	10.2	9.9	9.6
	-12.6	-13.0	11.1	10.9	10.7	10.4	10.1
	-10.5	-11.0	11.6	11.5	11.3	11.1	10.9
	-9.5	-10.0	11.8	11.7	11.5	11.4	11.2
	-8.5	-9.1	12.1	11.9	11.8	11.6	11.3
	-7.0	-7.6	12.4	12.2	12.1	11.8	11.5
	-5.0	-5.6	13.1	12.9	12.7	12.3	12.0
	-3.0	-3.7	13.8	13.6	13.4	12.9	12.4
	0.0	-0.7	14.4	14.2	14.0	13.4	12.8
	3.0	2.2	15.1	14.9	14.7	14.1	13.5
	5.0	4.1	15.8	15.6	15.3	14.4	13.5
	7.0	6.0	16.5	16.2	16.0	14.8	13.5
9.0	7.9	17.0	16.5	16.0	14.8	13.5	
11.0	9.8	17.5	16.7	16.0	14.8	13.5	
13.0	11.8	18.0	17.0	16.0	14.8	13.5	
15.0	13.7	18.5	17.2	16.0	14.8	13.5	

3. Capacity Table

Duct S (AM***HNHPKH/EU)

Cooling

TC: Total Capacity, SHC: Sensible Heat Capacity

Capacity Index	Outdoor Air Temp. (°C,DB)	Indoor temperature													
		20(°C,DB)		23(°C,DB)		26(°C,DB)		27(°C,DB)		28(°C,DB)		30(°C,DB)		32(°C,DB)	
		14(°C,WB)		16(°C,WB)		18(°C,WB)		19(°C,WB)		20(°C,WB)		22(°C,WB)		24(°C,WB)	
		TC	SHC	TC	SHC	TC	SHC	TC	SHC	TC	SHC	TC	SHC	TC	SHC
112	10	7.7	6.8	9.1	7.7	10.5	8.2	11.2	8.6	11.6	8.8	12.5	8.9	13.4	8.6
	12	7.7	6.8	9.1	7.7	10.5	8.2	11.2	8.6	11.6	8.8	12.5	8.9	13.4	8.6
	14	7.7	6.8	9.1	7.7	10.5	8.2	11.2	8.6	11.6	8.8	12.5	8.9	13.4	8.6
	16	7.7	6.8	9.1	7.7	10.5	8.2	11.2	8.6	11.6	8.8	12.5	8.9	13.3	8.5
	18	7.7	6.8	9.1	7.7	10.5	8.2	11.2	8.6	11.6	8.8	12.5	8.9	13.3	8.5
	20	7.7	6.8	9.1	7.7	10.5	8.2	11.2	8.6	11.6	8.8	12.4	8.8	13.2	8.5
	21	7.7	6.8	9.1	7.7	10.5	8.2	11.2	8.6	11.6	8.8	12.4	8.8	13.2	8.5
	23	7.7	6.8	9.1	7.7	10.5	8.2	11.2	8.6	11.6	8.8	12.4	8.8	13.2	8.5
	25	7.7	6.8	9.1	7.7	10.5	8.2	11.2	8.6	11.6	8.8	12.4	8.8	13.2	8.5
	27	7.7	6.8	9.1	7.7	10.5	8.2	11.2	8.6	11.6	8.8	12.4	8.8	13.2	8.5
	29	7.7	6.8	9.1	7.7	10.5	8.2	11.2	8.6	11.6	8.8	12.4	8.8	13.2	8.5
	31	7.7	6.8	9.1	7.7	10.5	8.2	11.2	8.6	11.6	8.8	12.4	8.8	13.2	8.5
	33	7.7	6.8	9.1	7.7	10.5	8.2	11.2	8.6	11.6	8.8	12.4	8.8	13.2	8.5
	35	7.7	6.8	9.1	7.7	10.5	8.2	11.2	8.6	11.6	8.8	12.4	8.7	13.2	8.5
	37	7.7	6.8	9.1	7.7	10.5	8.2	11.2	8.6	11.6	8.8	12.4	8.9	13.2	8.5
	39	7.7	6.8	9.1	7.7	10.5	8.2	11.2	8.6	11.6	8.8	12.3	8.8	13.0	8.4
42	7.7	6.8	9.1	7.7	10.4	8.1	11.1	8.5	11.5	8.7	12.1	8.6	12.7	8.2	
44	7.7	6.8	9.1	7.7	10.1	7.9	10.7	8.2	11.1	8.4	11.6	8.3	12.2	7.9	
46	7.7	6.8	9.0	7.6	10.0	7.8	10.4	8.0	10.8	8.2	11.2	8.0	11.9	7.7	
48	7.6	6.7	8.9	7.5	9.8	7.7	10.1	7.7	10.6	8.0	10.9	7.8	11.5	7.4	
128	10	8.8	7.8	10.4	8.9	12.0	9.5	12.8	9.9	13.3	9.9	14.3	10.0	15.4	9.9
	12	8.8	7.8	10.4	8.9	12.0	9.5	12.8	9.9	13.3	9.9	14.3	10.0	15.3	9.8
	14	8.8	7.8	10.4	8.9	12.0	9.5	12.8	9.9	13.3	9.9	14.3	10.0	15.3	9.8
	16	8.8	7.8	10.4	8.9	12.0	9.5	12.8	9.9	13.3	9.9	14.2	9.9	15.2	9.8
	18	8.8	7.8	10.4	8.9	12.0	9.5	12.8	9.9	13.3	9.9	14.2	9.9	15.1	9.7
	20	8.8	7.8	10.4	8.9	12.0	9.5	12.8	9.9	13.3	9.9	14.2	9.9	15.1	9.7
	21	8.8	7.8	10.4	8.9	12.0	9.5	12.8	9.9	13.3	9.9	14.2	9.9	15.1	9.7
	23	8.8	7.8	10.4	8.9	12.0	9.5	12.8	9.9	13.3	9.9	14.2	9.9	15.1	9.7
	25	8.8	7.8	10.4	8.9	12.0	9.5	12.8	9.9	13.3	9.9	14.2	9.9	15.1	9.7
	27	8.8	7.8	10.4	8.9	12.0	9.5	12.8	9.9	13.3	9.9	14.2	9.9	15.1	9.7
	29	8.8	7.8	10.4	8.9	12.0	9.5	12.8	9.9	13.3	9.9	14.2	9.9	15.1	9.7
	31	8.8	7.8	10.4	8.9	12.0	9.5	12.8	9.9	13.3	9.9	14.2	9.9	15.1	9.7
	33	8.8	7.8	10.4	8.9	12.0	9.5	12.8	9.9	13.3	9.9	14.2	9.9	15.1	9.7
	35	8.8	7.8	10.4	8.9	12.0	9.5	12.8	9.9	13.3	9.9	14.2	9.9	15.1	9.7
	37	8.8	7.8	10.4	8.9	12.0	9.5	12.8	9.9	13.2	9.9	14.0	9.8	14.9	9.6
	39	8.8	7.8	10.4	8.9	12.0	9.5	12.8	9.9	13.1	9.8	13.8	9.6	14.5	9.4
42	8.8	7.8	10.4	8.9	11.9	9.4	12.6	9.8	12.9	9.7	13.6	9.4	14.1	9.2	
44	8.8	7.8	10.4	8.9	11.6	9.2	12.2	9.5	12.6	9.4	13.0	9.1	13.6	8.8	
46	8.8	7.8	10.3	8.8	11.4	9.0	11.8	9.2	12.2	9.1	12.6	8.8	13.3	8.6	
48	8.7	7.7	10.2	8.7	11.2	8.9	11.5	8.9	12.0	8.9	12.2	8.5	12.8	8.3	
140	10	9.7	8.6	11.4	9.7	13.1	10.5	14.0	10.8	14.6	10.9	15.7	11.0	16.8	10.9
	12	9.7	8.6	11.4	9.7	13.1	10.5	14.0	10.8	14.5	10.8	15.6	10.9	16.7	10.8
	14	9.7	8.6	11.4	9.7	13.1	10.5	14.0	10.8	14.5	10.8	15.6	10.9	16.7	10.8
	16	9.7	8.6	11.4	9.7	13.1	10.5	14.0	10.8	14.5	10.8	15.6	10.9	16.6	10.7
	18	9.7	8.6	11.4	9.7	13.1	10.5	14.0	10.8	14.5	10.8	15.5	10.8	16.6	10.7
	20	9.7	8.6	11.4	9.7	13.1	10.5	14.0	10.8	14.5	10.8	15.5	10.8	16.5	10.6
	21	9.7	8.6	11.4	9.7	13.1	10.5	14.0	10.8	14.5	10.8	15.5	10.8	16.5	10.6
	23	9.7	8.6	11.4	9.7	13.1	10.5	14.0	10.8	14.5	10.8	15.5	10.8	16.5	10.6
	25	9.7	8.6	11.4	9.7	13.1	10.5	14.0	10.8	14.5	10.8	15.5	10.8	16.5	10.6
	27	9.7	8.6	11.4	9.7	13.1	10.5	14.0	10.8	14.5	10.8	15.5	10.8	16.5	10.6
	29	9.7	8.6	11.4	9.7	13.1	10.5	14.0	10.8	14.5	10.8	15.5	10.8	16.5	10.6
	31	9.7	8.6	11.4	9.7	13.1	10.5	14.0	10.8	14.5	10.8	15.5	10.8	16.5	10.6
	33	9.7	8.6	11.4	9.7	13.1	10.5	14.0	10.8	14.5	10.8	15.5	10.8	16.5	10.6
	35	9.7	8.6	11.4	9.7	13.1	10.5	14.0	10.8	14.5	10.8	15.5	10.8	16.5	10.6
	37	9.7	8.6	11.4	9.7	13.1	10.5	14.0	10.8	14.5	10.8	15.4	10.7	16.3	10.5
	39	9.7	8.6	11.4	9.7	13.1	10.5	14.0	10.8	14.4	10.7	15.1	10.5	15.9	10.3
42	9.7	8.6	11.4	9.7	13.0	10.4	13.8	10.7	14.2	10.6	14.8	10.3	15.5	10.0	
44	9.7	8.6	11.4	9.7	12.7	10.1	13.4	10.3	13.8	10.3	14.2	9.9	15.0	9.7	
46	9.7	8.6	11.3	9.6	12.4	10.0	12.9	10.0	13.4	10.0	13.8	9.6	14.6	9.4	
48	9.6	8.5	11.1	9.5	12.2	9.8	12.6	9.7	13.1	9.8	13.4	9.3	14.1	9.1	

3. Capacity Table

Duct S (AM***HNHPKH/EU)

Heating

TC: Total Capacity

Capacity Index	Outdoor Air Temp. (°C)		Indoor temperature (°C,DB)				
			16(°C,DB)	18(°C,DB)	20(°C,DB)	22(°C,DB)	24(°C,DB)
	DB	WB	TC kW	TC kW	TC kW	TC kW	TC kW
112	-19.8	-20.0	7.4	7.4	7.3	7.3	7.3
	-18.8	-19.0	7.6	7.6	7.4	7.4	7.3
	-16.7	-17.0	8.1	7.8	7.6	7.5	7.4
	-14.7	-15.0	8.4	8.2	8.0	7.8	7.6
	-12.6	-13.0	8.7	8.5	8.3	8.1	8.0
	-10.5	-11.0	9.1	8.9	8.8	8.7	8.6
	-9.5	-10.0	9.3	9.1	9.0	8.9	8.8
	-8.5	-9.1	9.5	9.3	9.2	9.0	8.9
	-7.0	-7.6	9.7	9.6	9.4	9.2	9.0
	-5.0	-5.6	10.2	10.1	9.9	9.6	9.3
	-3.0	-3.7	10.7	10.6	10.5	10.1	9.7
	0.0	-0.7	11.3	11.1	11.1	10.5	10.0
	3.0	2.2	11.8	11.6	11.5	11.0	10.6
	5.0	4.1	12.3	12.2	12.0	11.3	10.6
	7.0	6.0	12.9	12.7	12.5	11.5	10.6
9.0	7.9	13.3	12.9	12.5	11.5	10.6	
11.0	9.8	13.7	13.1	12.5	11.5	10.6	
13.0	11.8	14.0	13.3	12.5	11.5	10.6	
15.0	13.7	14.4	13.5	12.5	11.5	10.6	
128	-19.8	-20.0	8.1	8.1	8.0	8.0	8.0
	-18.8	-19.0	8.3	8.3	8.2	8.1	8.0
	-16.7	-17.0	8.8	8.6	8.4	8.3	8.1
	-14.7	-15.0	9.3	9.1	8.8	8.6	8.3
	-12.6	-13.0	9.6	9.4	9.2	9.0	8.8
	-10.5	-11.0	10.0	9.9	9.8	9.6	9.4
	-9.5	-10.0	10.2	10.1	10.0	9.8	9.7
	-8.5	-9.1	10.4	10.3	10.2	10.0	9.8
	-7.0	-7.6	10.7	10.6	10.4	10.2	10.0
	-5.0	-5.6	11.3	11.1	11.0	10.7	10.3
	-3.0	-3.7	11.9	11.7	11.5	11.1	10.7
	0.0	-0.7	12.4	12.3	12.1	11.6	11.0
	3.0	2.2	13.0	12.9	12.7	12.2	11.7
	5.0	4.1	13.6	13.4	13.2	12.4	11.7
	7.0	6.0	14.2	14.0	13.8	12.7	11.7
9.0	7.9	14.6	14.2	13.8	12.7	11.7	
11.0	9.8	15.1	14.4	13.8	12.7	11.7	
13.0	11.8	15.5	14.7	13.8	12.7	11.7	
15.0	13.7	15.9	14.9	13.8	12.7	11.7	
140	-19.8	-20.0	9.5	9.5	9.4	9.4	9.3
	-18.8	-19.0	9.7	9.7	9.5	9.5	9.3
	-16.7	-17.0	10.2	10.0	9.7	9.6	9.4
	-14.7	-15.0	10.8	10.5	10.2	9.9	9.6
	-12.6	-13.0	11.1	10.9	10.7	10.4	10.1
	-10.5	-11.0	11.6	11.5	11.3	11.1	10.9
	-9.5	-10.0	11.8	11.7	11.5	11.4	11.2
	-8.5	-9.1	12.1	11.9	11.8	11.6	11.3
	-7.0	-7.6	12.4	12.2	12.1	11.8	11.5
	-5.0	-5.6	13.1	12.9	12.7	12.3	12.0
	-3.0	-3.7	13.8	13.6	13.4	12.9	12.4
	0.0	-0.7	14.4	14.2	14.0	13.4	12.8
	3.0	2.2	15.1	14.9	14.7	14.1	13.5
	5.0	4.1	15.8	15.6	15.3	14.4	13.5
	7.0	6.0	16.5	16.2	16.0	14.8	13.5
9.0	7.9	17.0	16.5	16.0	14.8	13.5	
11.0	9.8	17.5	16.7	16.0	14.8	13.5	
13.0	11.8	18.0	17.0	16.0	14.8	13.5	
15.0	13.7	18.5	17.2	16.0	14.8	13.5	

4. Dimensional Drawing

Duct S

AM036HNMPKH/EU, AM045HNMPKH/EU, AM056HNMPKH/EU, AM071HNMPKH/EU

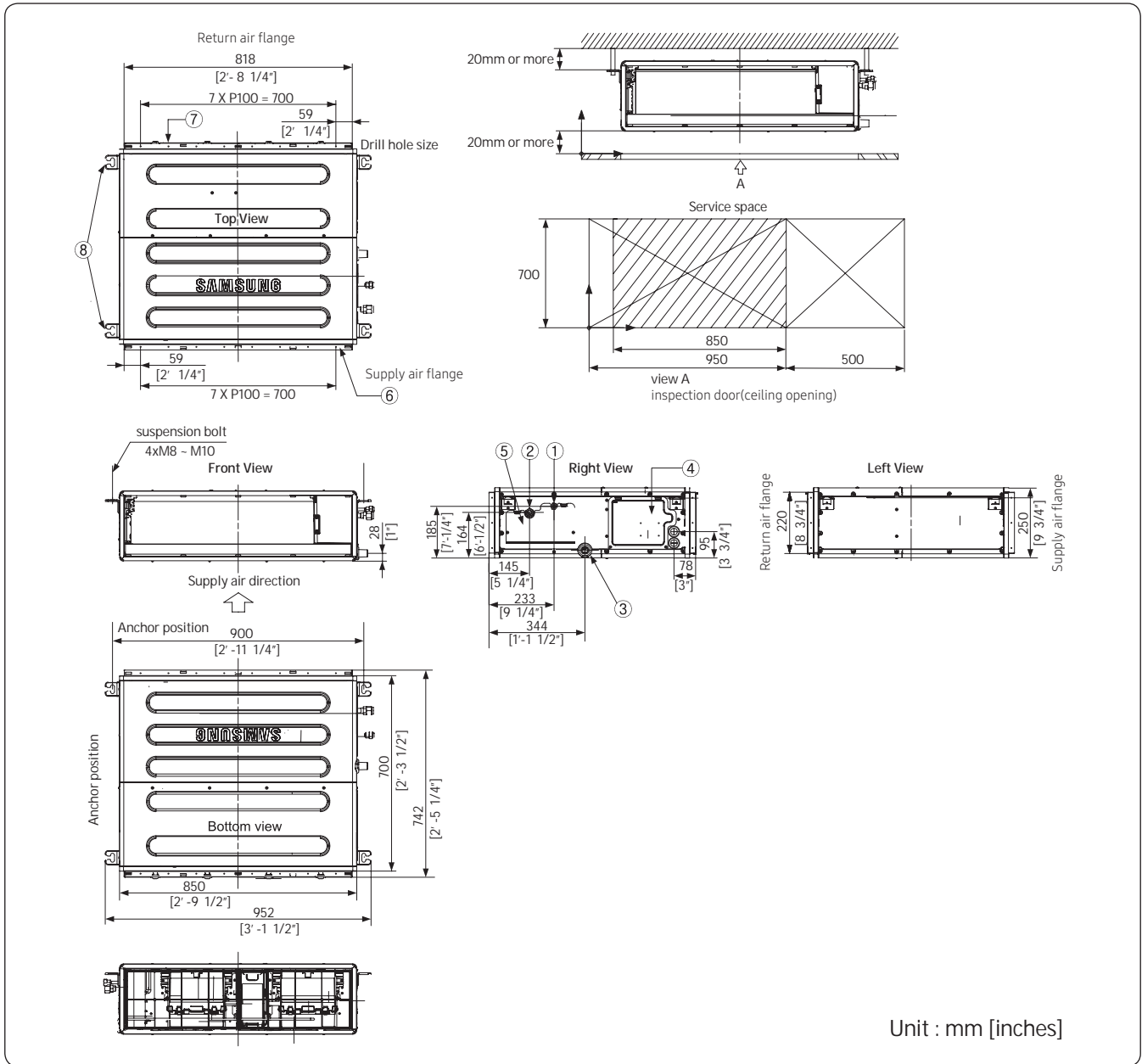

No.	Name	Description	
		~ 5.6 kW	7.1 kW
①	Refrigerant liquid pipe	Ø6.35 [1/4"] Flare	Ø9.52 [3/8"] Flare
②	Refrigerant gas pipe	Ø12.7 [1/2"] Flare	Ø15.88 [5/8"] Flare
③	Condensate drain	VP25 (OD 32, ID 25)	
④	Power & Comm. wiring conduits	-	
⑤	Refrigerant pipe conduits	-	
⑥	Supply air flange	-	
⑦	Return air flange	-	
⑧	Hook	-	

4. Dimensional Drawing

Duct S

AM090HNMPKH/EU

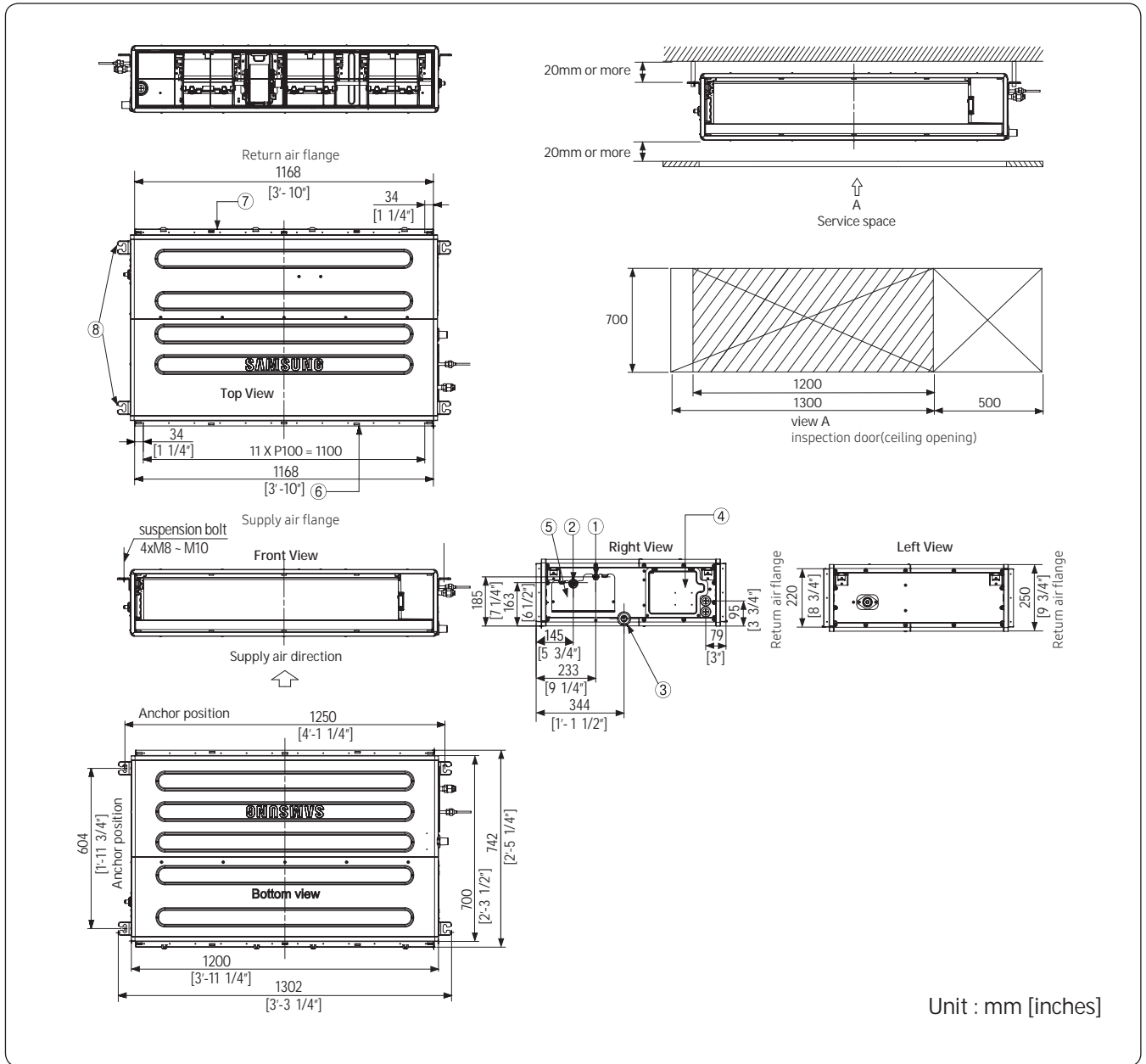

No.	Name	Description
①	Refrigerant liquid pipe	Ø9.52 [3/8"] Flare connection
②	Refrigerant gas pipe	Ø15.88 [5/8"] Flare connection
③	Condensate drain	VP25 (OD 32, ID 25)
④	Power & Comm. wiring conduits	-
⑤	Refrigerant pipe conduits	-
⑥	Supply air flange	-
⑦	Return air flange	-
⑧	Hook	-

4. Dimensional Drawing

Duct S

AM112HNMPKH/EU, AM128HNMPKH/EU, AM140HNMPKH/EU, AM112HNHPKH/EU, AM128HNHPKH/EU, AM140HNHPKH/EU

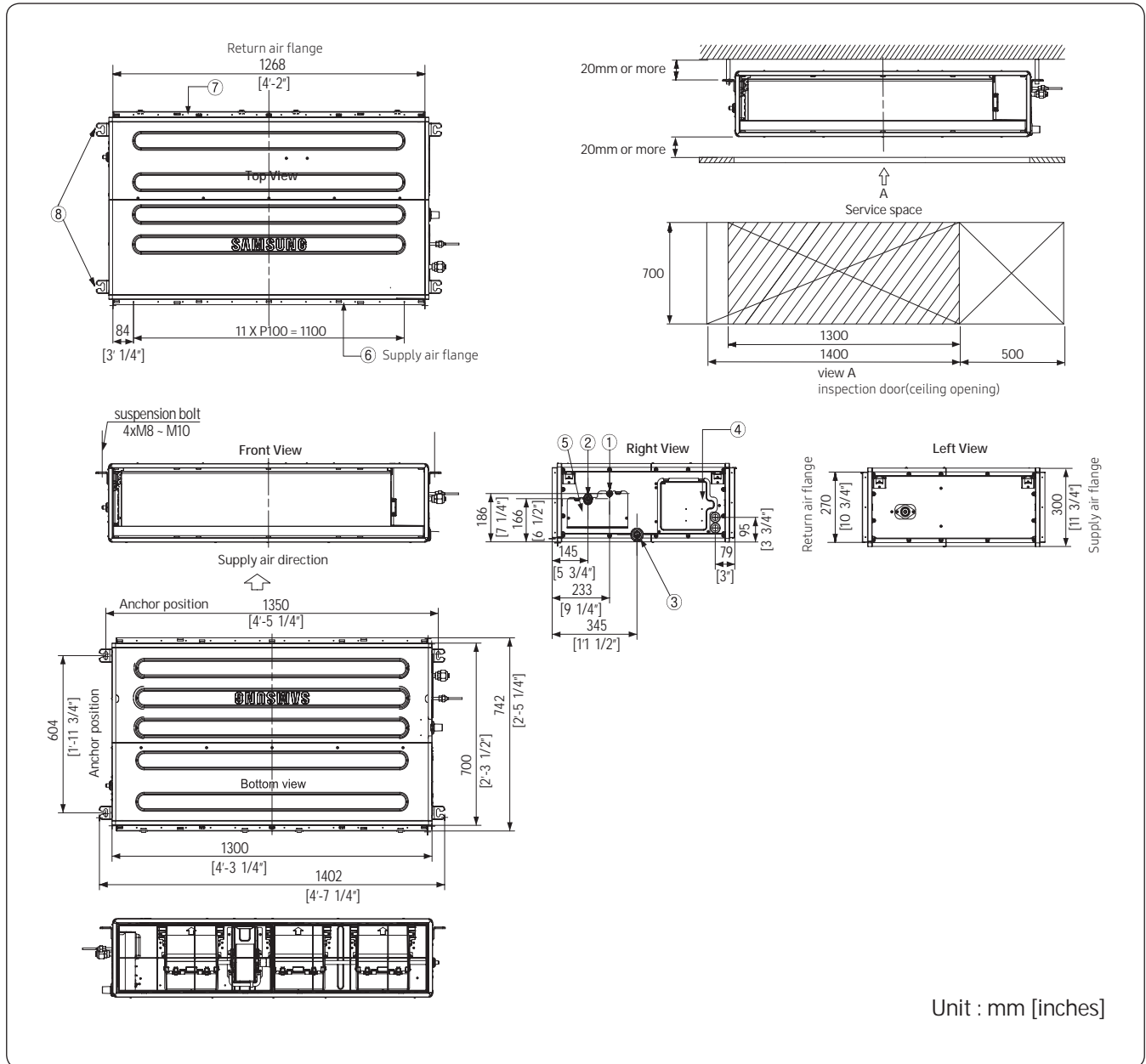

No.	Name	Description
①	Refrigerant liquid pipe	Ø9.52 [3/8"] Flare connection
②	Refrigerant gas pipe	Ø15.88 [5/8"] Flare connection
③	Condensate drain	VP25 (OD 32, ID 25)
④	Power & Comm. wiring conduits	-
⑤	Refrigerant pipe conduits	-
⑥	Supply air flange	-
⑦	Return air flange	-
⑧	Hook	-

5. Center of Gravity

Duct S

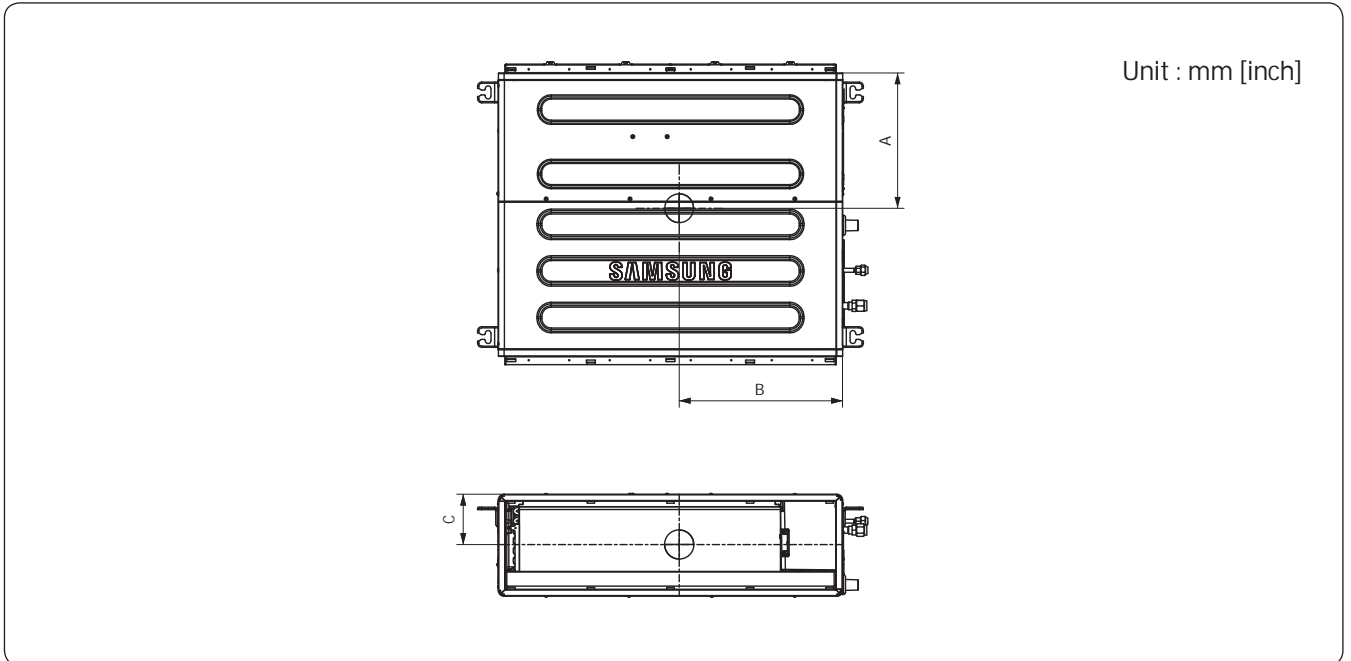

Model	A	B	C
3.6kW / 4.5kW / 5.6kW / 7.1kW	334	403	125
9.0kW	266	564	125
11.2kW / 12.8kW / 14.0kW	266	650	150

6. Electrical Wiring Diagram

Duct S

AM036HNMPKH/EU, AM045HNMPKH/EU, AM056HNMPKH/EU, AM071HNMPKH/EU, AM090HNMPKH/EU, AM112HNMPKH/EU, AM128HNMPKH/EU, AM140HNMPKH/EU

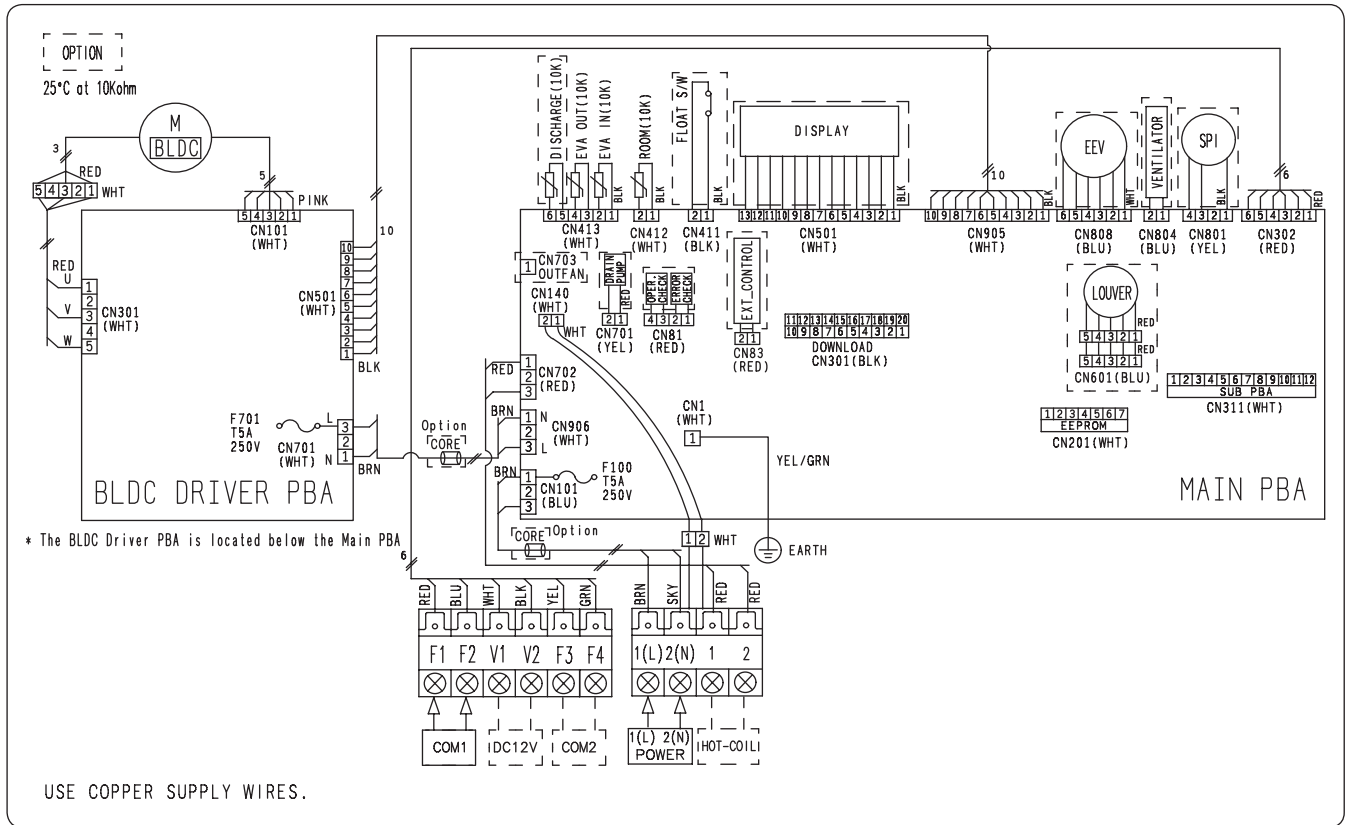

MAIN PBA	Printed Circuit board(MAIN)	EEV	electronic expansion valve	DISCHARGE(10K)	Thermistor DISCHARGE(10K)
BLDC DRIVER PBA	Printed Circuit board(BLDC DRIVER)	SPI		EVA-OUT(10K)	Thermistor EVA OUT(10K)
EMI PBA	Printed Circuit board(emi)	ROOM(10K)	Thermistor ROOM OUT(10K)	EVA-IN(10K)	Thermistor EVA IN(10K)

NOTE

- This wiring diagram applies only to the Indoor unit.
- Symbols show as follow :
blk: black, red: red, blu: blue, wht: white, yel: yellow, brn: brown, sky: sky blue, grn: green
- For connection wiring indoor-outdoor transmission F1-F2, indoor-wired remote controller transmission F3-F4.
- ⊕ Protective earth(SCREW)

6. Electrical Wiring Diagram

Duct S

AM112HNHPKH/EU, AM128HNHPKH/EU, AM140HNHPKH/EU

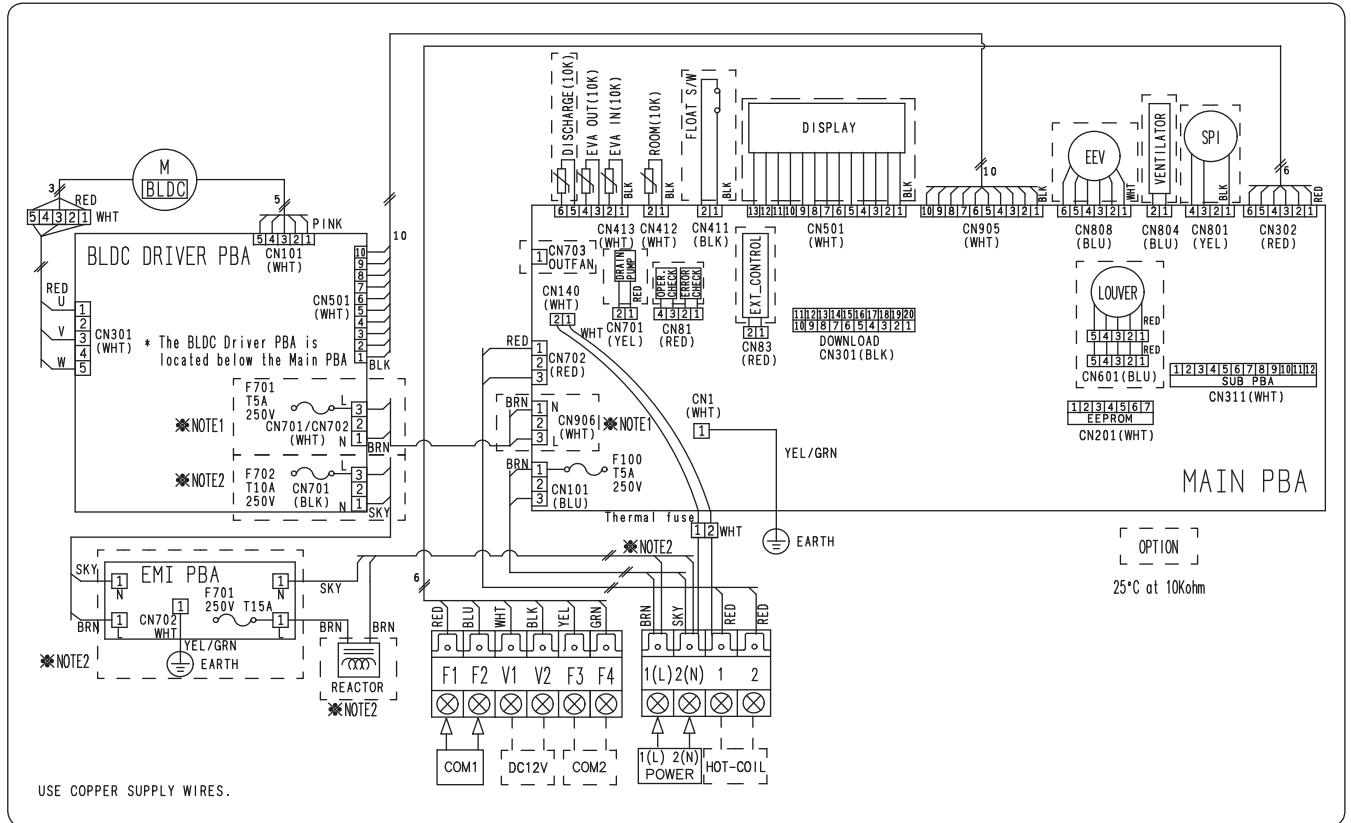

MAIN PBA	Printed Circuit board(MAIN)	EEV	electronic expansion valve	DISCHARGE(10K)	Thermistor DISCHARGE(10K)
BLDC DRIVER PBA	Printed Circuit board(BLDC DRIVER)	SPI		EVA-OUT(10K)	Thermistor EVA OUT(10K)
EMI PBA	Printed Circuit board(emi)	ROOM(10K)	Thermistor ROOM OUT(10K)	EVA-IN(10K)	Thermistor EVA IN(10K)

NOTE

- This wiring diagram applies only to the Indoor unit.
- Symbols show as follow :
blk: black, red: red, blu: blue, wht: white, yel: yellow, brn: brown, sky: sky blue, grn: green
- For connection wiring indoor-outdoor transmission F1-F2, indoor-wired remote controller transmission F3-F4.
- ⊕ Protective earth(SCREW)

7. Sound Data

Sound pressure level

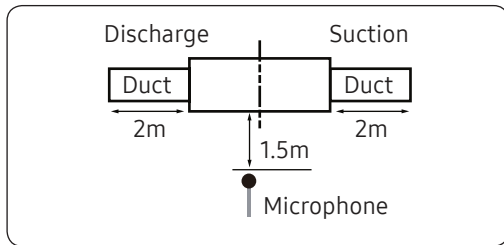

Unit: dB(A)

MODEL	HIGH	MID	LOW
AM036HNMPKH/EU	29	26	23
AM045HNMPKH/EU	31	28	24

NR Curve

1) AM036HNMPKH/EU

2) AM045HNMPKH/EU

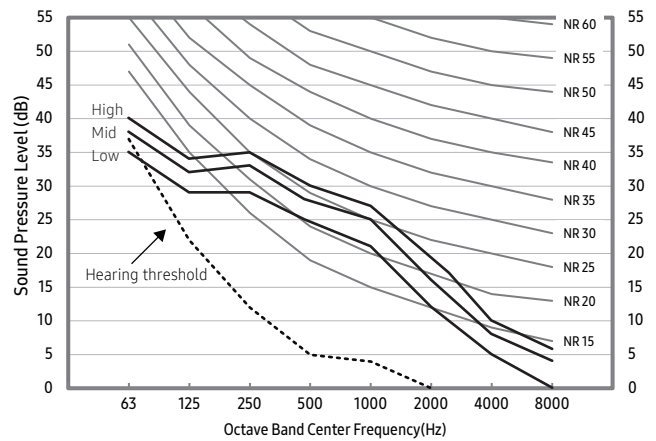
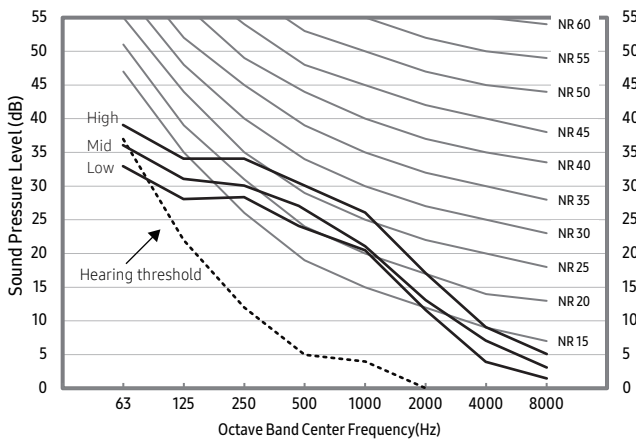

Fan options		ESP mmAq	Sound Pressure (dBA)		
			High	Mid	Low
Default	010054-1C5081-202424-331205	2.5	29	26	23
Option	010054-1C50E3-202424-331205	5.0	32	29	27
	010054-1C5459-202424-331205	7.5	33	30	28
	010054-1C54CD-202424-331205	10.0	34	31	29
	010054-1C5931-202424-331205	12.5	35	32	30
	010054-1C5983-202424-331205	15.0	35	33	31

Fan options		ESP mmAq	Sound Pressure (dBA)		
			High	Mid	Low
Default	010054-1C50D1-202D2D-331204	3.0	31	28	24
Option	010054-1C5453-202D2D-331204	6.0	33	31	28
	010054-1C5453-202D2D-331205	9.0	34	32	29
	010054-1C5453-202D2D-331206	12.0	35	33	30
	010054-1C5453-202D2D-331207	15.0	36	34	31

NOTE

- Specifications may be subject to change without prior notice.
 - Sound pressure level is obtained in an anechoic room.
 - Sound pressure level is a relative value, depending on the distance and acoustic environment.
 - Sound pressure level may differ depending on operation condition.
 - dBA = A-weighted sound pressure level.
 - Reference acoustic pressure 0 dB = 20μPa

7. Sound Data

Sound pressure level

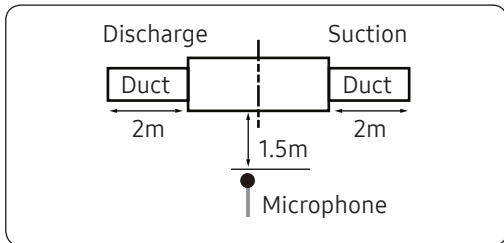

Unit: dB(A)

MODEL	HIGH	MID	LOW
AM056HNMPKH/EU	32	29	25
AM071HNMPKH/EU	37	33	29

NR Curve

3) AM056HNMPKH/EU

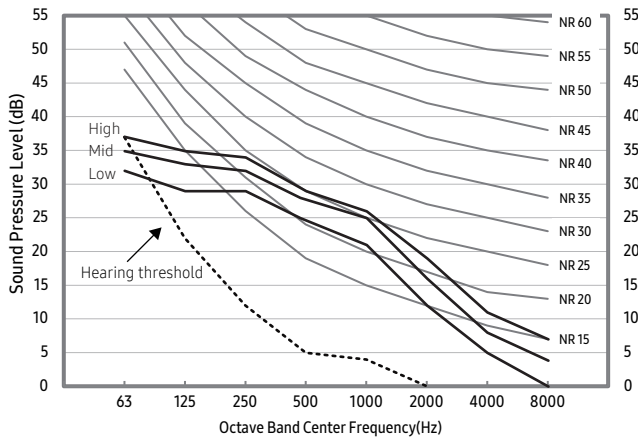

4) AM071HNMPKH/EU

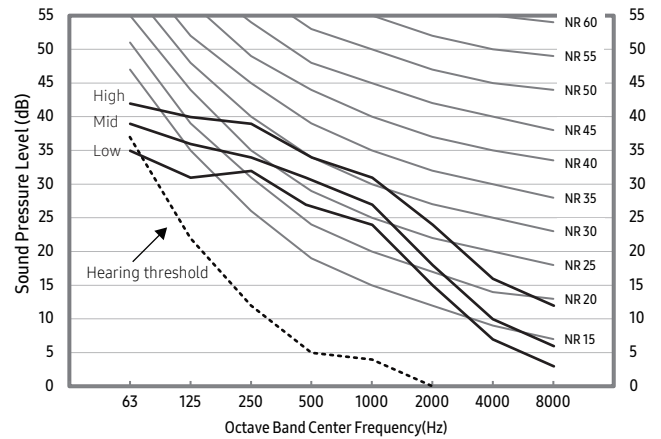

Fan options		ESP mmAq	Sound Pressure (dBA)		
			High	Mid	Low
Default	010054-1C50F1-203838-331203	3.0	32	29	25
Option	010054-1C5447-203838-331203	6.0	34	32	30
	010054-1C54AB-203838-331203	9.0	35	33	31
	010054-1C581F-203838-331203	12.0	36	34	32
	010054-1C5973-203838-331203	15.0	39	37	34

Fan options		ESP mmAq	Sound Pressure (dBA)		
			High	Mid	Low
Default	010054-1C548D-204747-331201	3.0	37	33	29
Option	010054-1C55E1-204747-331201	6.0	38	35	31
	010054-1C5935-204747-331201	9.0	40	37	33
	010054-1C5989-204747-331201	12.0	41	38	34
	010054-1C59DF-204747-331201	15.0	43	41	35

NOTE

- Specifications may be subject to change without prior notice.
 - Sound pressure level is obtained in an anechoic room.
 - Sound pressure level is a relative value, depending on the distance and acoustic environment.
 - Sound pressure level may differ depending on operation condition.
 - dBA = A-weighted sound pressure level.
 - Reference acoustic pressure 0 dB = 20μPa

7. Sound Data

Sound pressure level

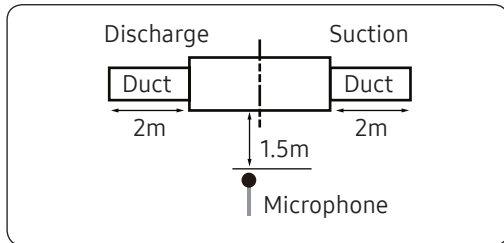

Unit: dB(A)

MODEL	HIGH	MID	LOW
AM090HNMPKH/EU	38	35	32
AM112HNMPKH/EU	38	35	32

NR Curve

1) AM090HNMPKH/EU

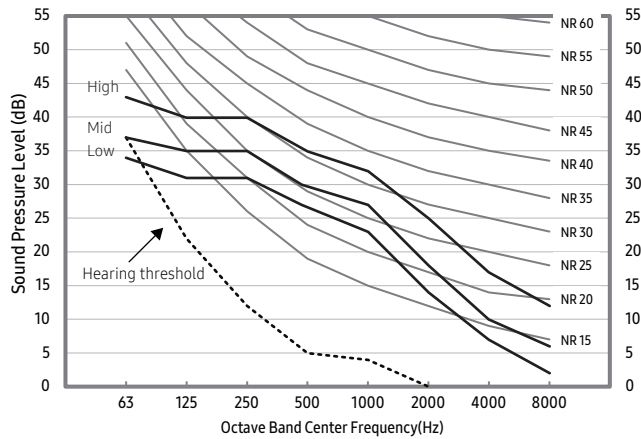

2) AM112HNMPKH/EU

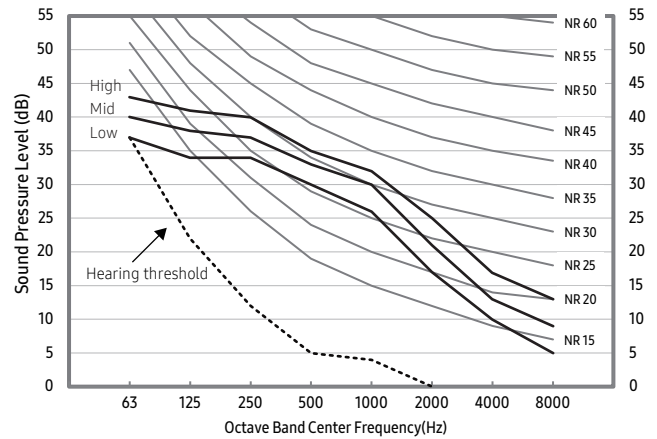

Fan options		ESP	Sound Pressure (dBA)		
			mmAq	High	Mid
Default	010054-1C546D-205A5A-331212	4.0	38	35	32
Option	010054-1C55E3-205A5A-331212	8.0	40	37	35
	010054-1C5969-205A5A-331212	12.0	42	40	38
	010054-1C59CD-205A5A-331212	15.0	45	43	40

Fan options		ESP	Sound Pressure (dBA)		
			mmAq	High	Mid
Default	010054-1C5412-207070-331223	5.2	38	35	32
Option	010054-1C5466-207070-331223	8.0	40	37	33
	010054-1C54EA-207070-331223	12.0	43	42	41
	010054-1C583E-207070-331223	15.0	46	45	44

NOTE

- Specifications may be subject to change without prior notice.
 - Sound pressure level is obtained in an anechoic room.
 - Sound pressure level is a relative value, depending on the distance and acoustic environment.
 - Sound pressure level may differ depending on operation condition.
 - dBA = A-weighted sound pressure level.
 - Reference acoustic pressure 0 dB = 20μPa

7. Sound Data

Sound pressure level

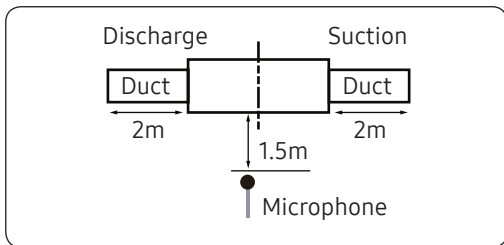

Unit: dB(A)

MODEL	HIGH	MID	LOW
AM128HNMPKH/EU	39	36	33
AM140HNMPKH/EU	40	37	33

NR Curve

3) AM128HNMPKH/EU

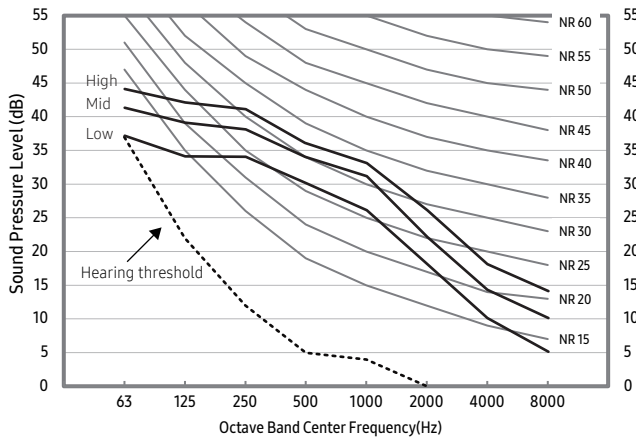

4) AM140HNMPKH/EU

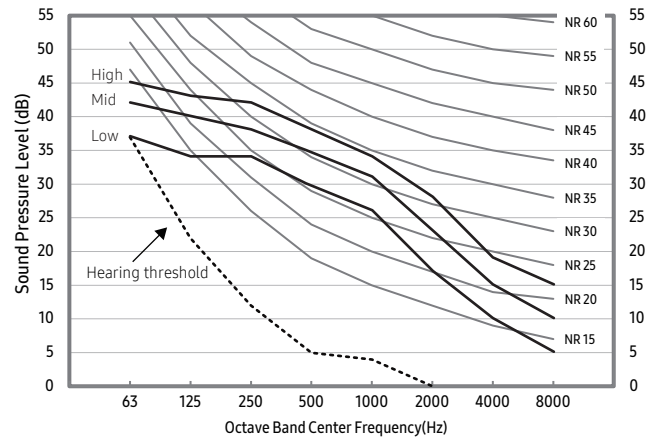

Fan options		ESP	Sound Pressure (dBA)		
			mmAq	High	Mid
Default	010054-1C5426-208080-331222	5.2	39	36	33
Option	010054-1C5478-208080-331222	8.0	42	39	35
	010054-1C54EE-208080-331222	12.0	44	43	42
	010054-1C5920-208080-331222	15.0	47	46	45

Fan options		ESP	Sound Pressure (dBA)		
			mmAq	High	Mid
Default	010054-1C5444-208C8C-331221	5.2	40	37	33
Option	010054-1C5498-208C8C-331221	8.0	44	40	35
	010054-1C54FA-208C8C-331221	12.0	45	43	42
	010054-1C583E-208C8C-331221	15.0	48	46	45

NOTE

- Specifications may be subject to change without prior notice.
 - Sound pressure level is obtained in an anechoic room.
 - Sound pressure level is a relative value, depending on the distance and acoustic environment.
 - Sound pressure level may differ depending on operation condition.
 - dBA = A-weighted sound pressure level.
 - Reference acoustic pressure 0 dB = 20μPa

7. Sound Data

Sound pressure level

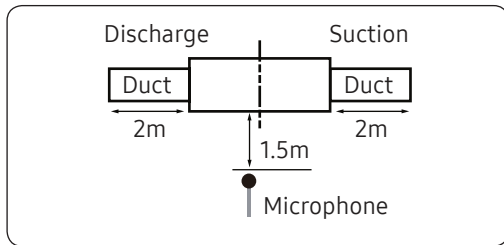

Unit: dB(A)

MODEL	HIGH	MID	LOW
AM112HNHPKH/EU	38	35	32
AM128HNHPKH/EU	39	36	33

NR Curve

1) AM112HNHPKH/EU

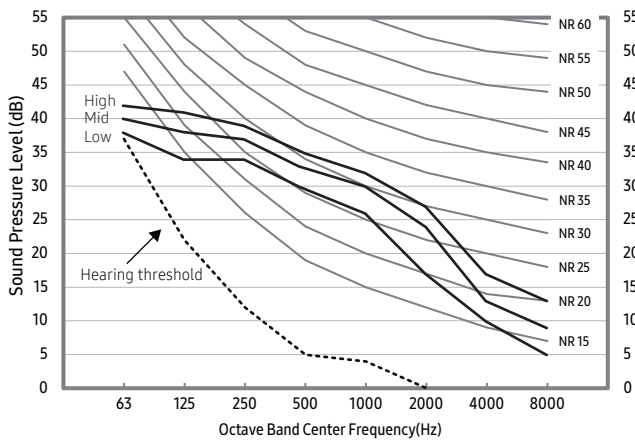

2) AM128HNHPKH/EU

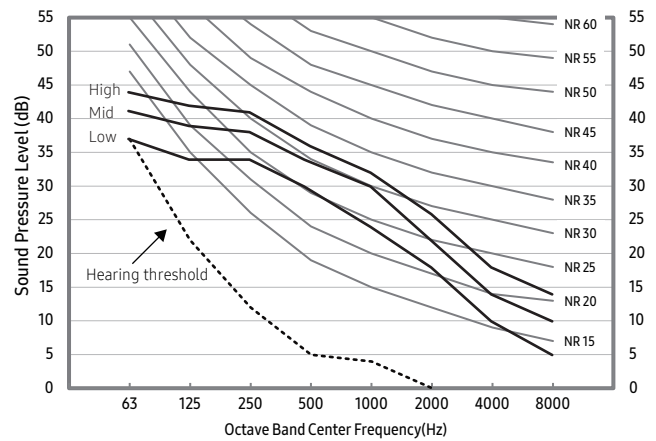

Fan options		ESP	Sound Pressure (dBA)		
			mmAq	High	Mid
Default	010054-1C5446-207070-331226	6.2	38	35	32
Option	010054-1C54A7-207070-331226	9.0	40	37	33
	010054-1C54C9-207070-331226	11.0	42	41	40
	010054-1C580B-207070-331226	13.0	43	42	41
	010054-1C584D-207070-331226	15.0	46	45	44
	010054-1C587F-207070-331226	17.0	47	46	45
	010054-1C59A1-207070-331226	19.0	48	47	46
	010054-1C59B2-207070-331226	20.0	49	48	47

Fan options		ESP	Sound Pressure (dBA)		
			mmAq	High	Mid
Default	010054-1C5466-208080-331225	6.2	39	36	33
Option	010054-1C54B9-208080-331225	9.0	42	39	35
	010054-1C54EC-208080-331225	11.0	44	43	42
	010054-1C581E-208080-331225	13.0	46	45	44
	010054-1C5940-208080-331225	15.0	47	46	45
	010054-1C5982-208080-331225	17.0	48	47	46
	010054-1C59B3-208080-331225	19.0	49	48	47
	010054-1C59C4-208080-331225	20.0	50	49	48

NOTE

- Specifications may be subject to change without prior notice.
 - Sound pressure level is obtained in an anechoic room.
 - Sound pressure level is a relative value, depending on the distance and acoustic environment.
 - Sound pressure level may differ depending on operation condition.
 - dBA = A-weighted sound pressure level.
 - Reference acoustic pressure 0 dB = 20μPa

7. Sound Data

Sound pressure level

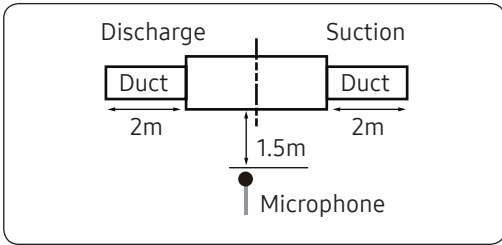

Unit: dB(A)			
MODEL	HIGH	MID	LOW
AM140HNHPKH/EU	40	37	34

NR Curve

3) AM140HNHPKH/EU

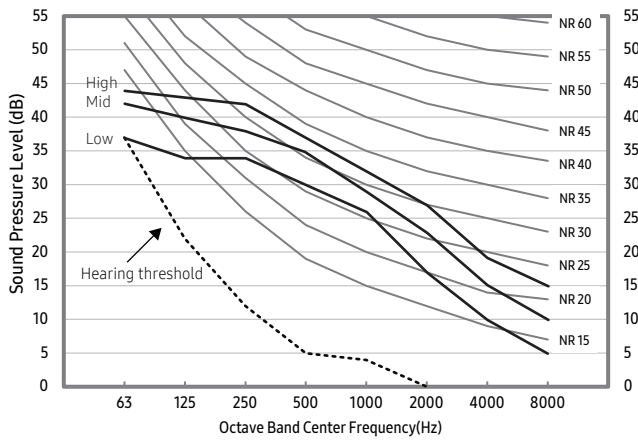

Fan options		ESP mmAq	Sound Pressure (dBA)		
			High	Mid	Low
Default	010054-1C5486-208C8C-331224	6.2	40	37	34
Option	010054-1C54D7-208C8C-331224	9.0	44	40	35
	010054-1C5809-208C8C-331224	11.0	45	43	42
	010054-1C583B-208C8C-331224	13.0	47	45	44
	010054-1C586D-208C8C-331224	15.0	48	46	45
	010054-1C588F-208C8C-331224	17.0	49	47	46
	010054-1C59C0-208C8C-331224	19.0	50	48	47
	010054-1C59D1-208C8C-331224	20.0	51	49	48

NOTE

- Specifications may be subject to change without prior notice.
 - Sound pressure level is obtained in an anechoic room.
 - Sound pressure level is a relative value, depending on the distance and acoustic environment.
 - Sound pressure level may differ depending on operation condition.
 - dBA = A-weighted sound pressure level.
 - Reference acoustic pressure 0 dB = 20μPa

7. Sound Data

Sound power level

Unit: dB(A)

MODEL	Power	MODEL	Power
AM036HNMPKH/EU	47	AM056HNMPKH/EU	49
AM045HNMPKH/EU	49	AM071HNMPKH/EU	57

1) AM036HNMPKH/EU

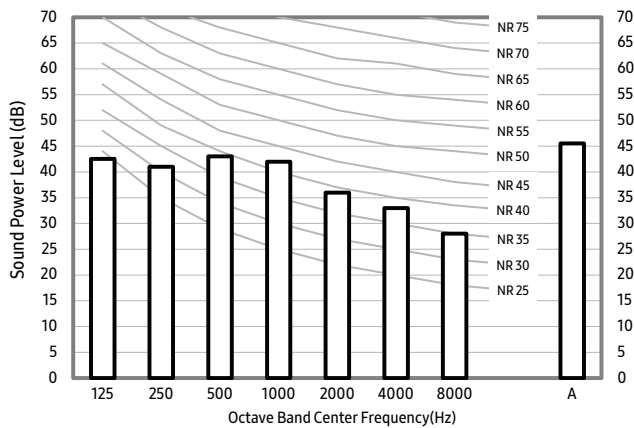

2) AM045HNMPKH/EU

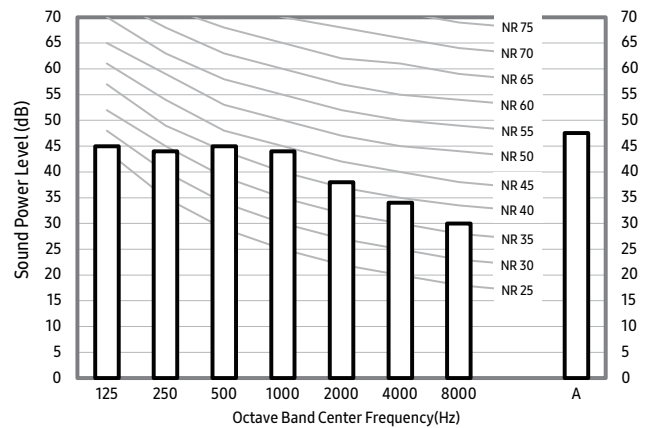

3) AM056HNMPKH/EU

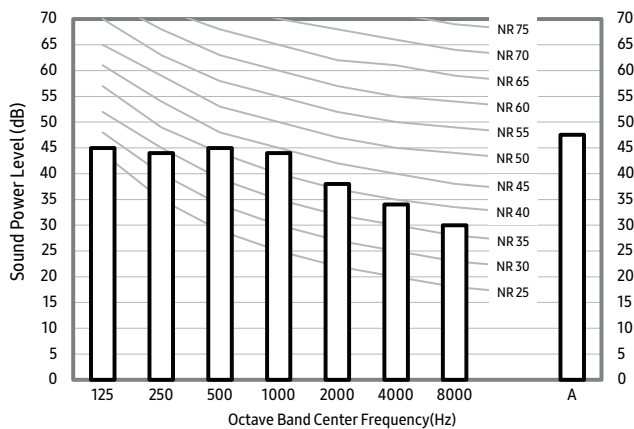

4) AM071HNMPKH/EU

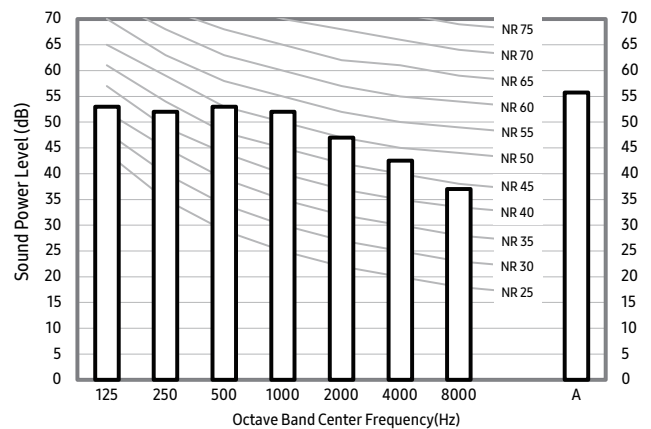

NOTE

- Specifications may be subject to change without prior notice
 - Sound power level is an absolute value that a sound source generates
 - dBA = A-weighted sound power level
 - Reference power : 1pW
 - Measured according to ISO 3741

7. Sound Data

Sound power level

Unit: dB(A)

MODEL	Power	MODEL	Power
AM090HNMPKH/EU	58	AM128HNMPKH/EU	62
AM112HNMPKH/EU	62	AM140HNMPKH/EU	64

1) AM090HNMPKH/EU

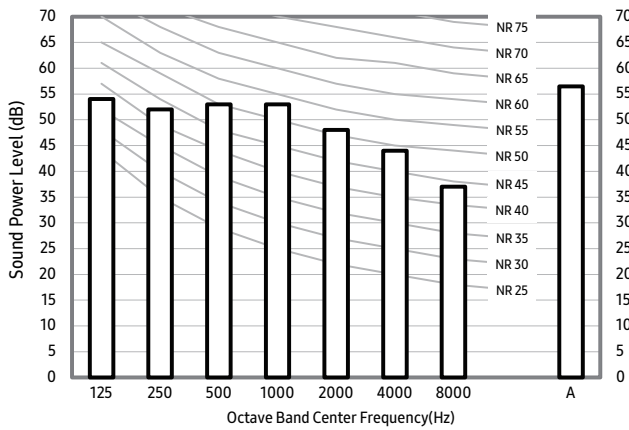

2) AM112HNMPKH/EU

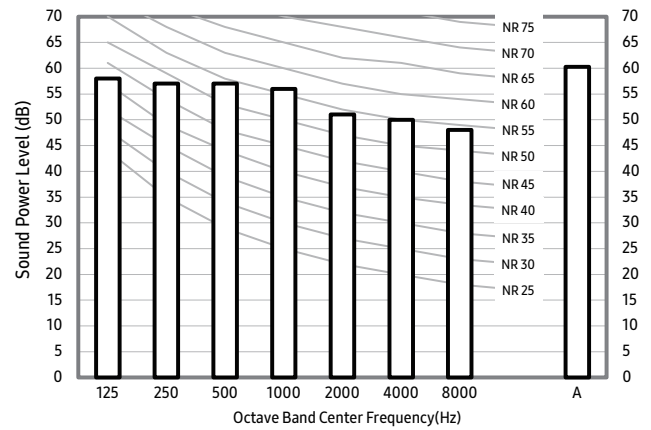

3) AM128HNMPKH/EU

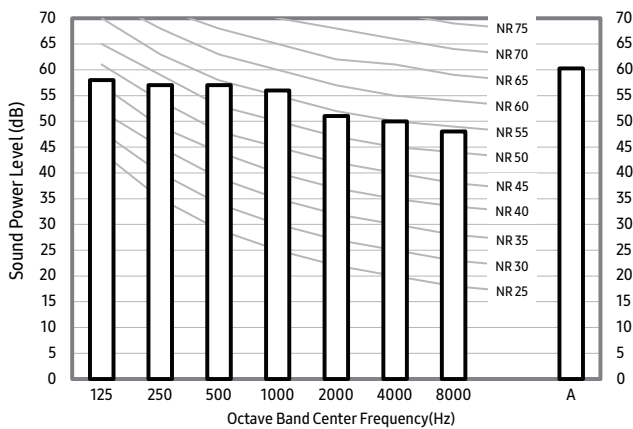

4) AM140HNMPKH/EU

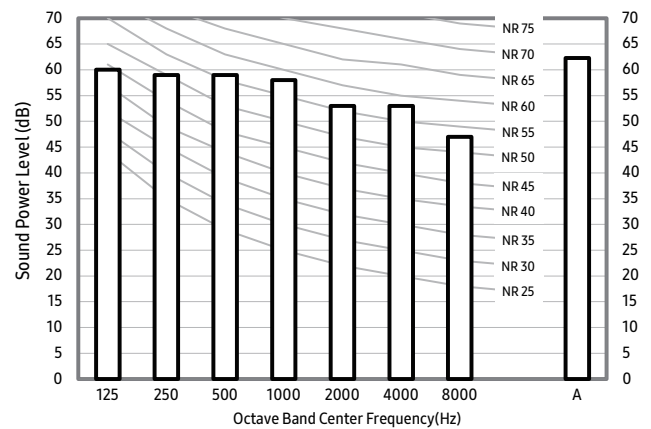

NOTE

- Specifications may be subject to change without prior notice
 - Sound power level is an absolute value that a sound source generates
 - dBA = A-weighted sound power level
 - Reference power : 1pW
 - Measured according to ISO 3741

7. Sound Data

Sound power level

Unit: dB(A)

MODEL	Power	MODEL	Power
AM112HNHPKH/EU	63	AM140HNHPKH/EU	65
AM128HNHPKH/EU	63		

1) AM112HNHPKH/EU

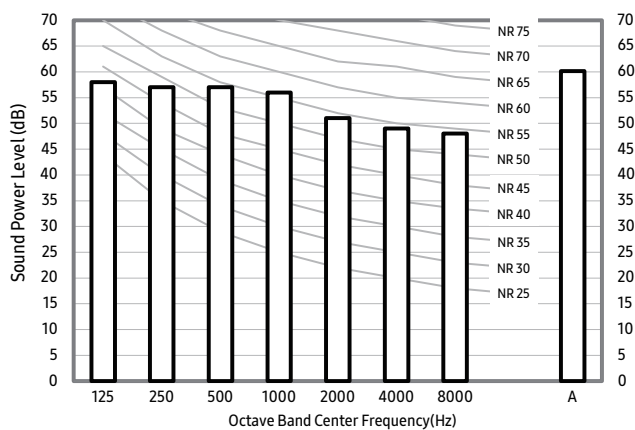

2) AM128HNHPKH/EU

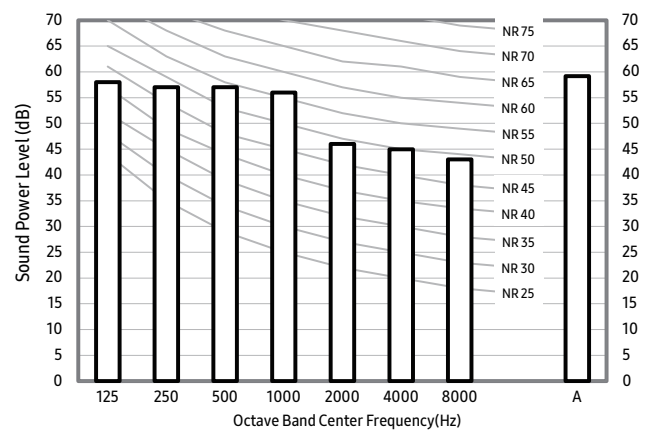

3) AM140HNHPKH/EU

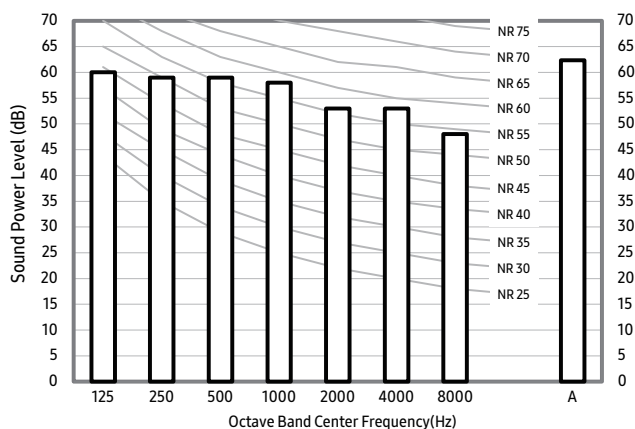

NOTE

- Specifications may be subject to change without prior notice
 - Sound power level is an absolute value that a sound source generates
 - dBA = A-weighted sound power level
 - Reference power : 1pW
 - Measured according to ISO 3741

8. Fan Characteristics

1) AM036HNMPKH/EU

①	External Static Pressure(mmAq)	Option Code
	0 < SP ≤ 2.5	010054-1C5081-202424-331205

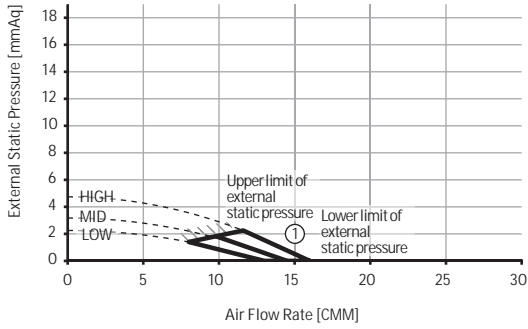

②	External Static Pressure(mmAq)	Option Code
	2.5 < SP ≤ 5	010054-1C50E3-202424-331205

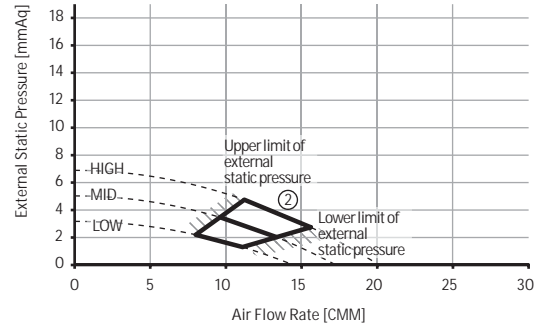

③	External Static Pressure(mmAq)	Option Code
	5 < SP ≤ 7.5	010054-1C5459-202424-331205

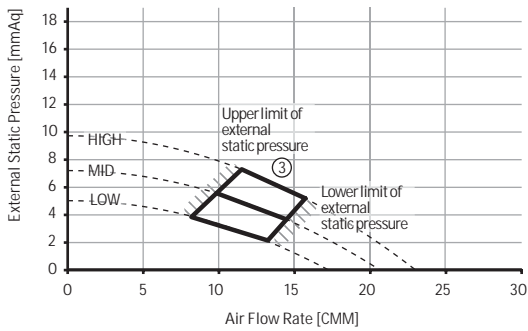

④	External Static Pressure(mmAq)	Option Code
	7.5 < SP ≤ 10	010054-1C54CD-202424-331205

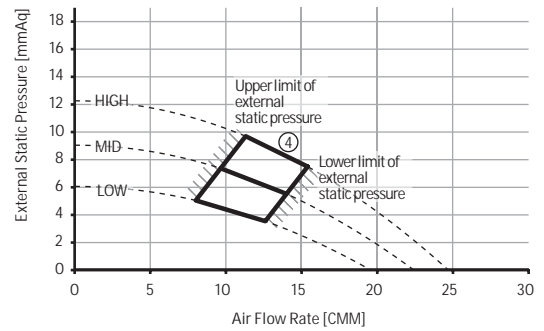

⑤	External Static Pressure(mmAq)	Option Code
	10 < SP ≤ 12.5	010054-1C5931-202424-331205

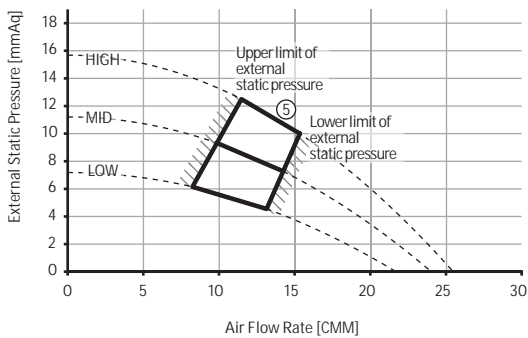

⑥	External Static Pressure(mmAq)	Option Code
	12.5 < SP ≤ 15	010054-1C5983-202424-331205

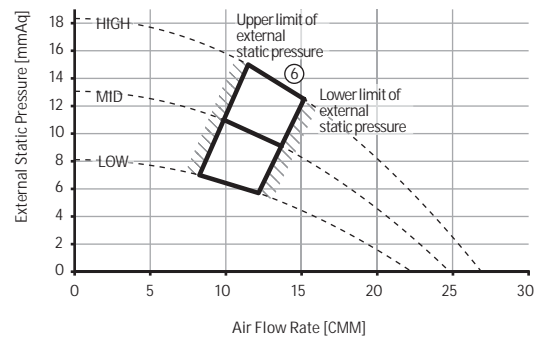

Note

Adjust option code according to the actual installation condition (external static pressure).

ESP = External Static Pressure

The graphs display the available external static pressure range of installed indoor units. Therefore, they do not reflect the actual change of external static pressure and airflow rate according to adjusted airflow (High-Mid-Low) of installed indoor units.

8. Fan Characteristics

2) AMO45HNMPKH/EU

①	External Static Pressure(mmAq)	Option Code
	$0 \leq SP \leq 3$	010054-1C50D1-202D2D-331204

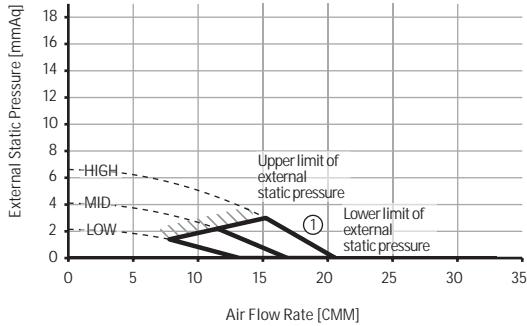

②	External Static Pressure(mmAq)	Option Code
	$3 < SP \leq 6$	010054-1C5453-202D2D-331204

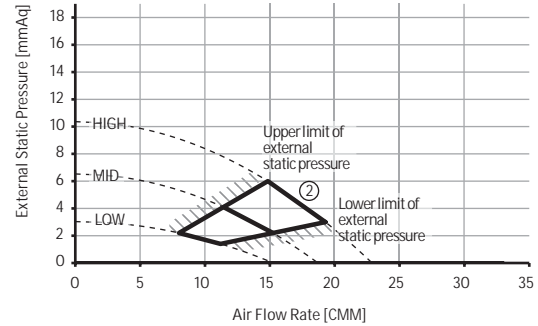

③	External Static Pressure(mmAq)	Option Code
	$6 < SP \leq 9$	010054-1C54C7-202D2D-331204

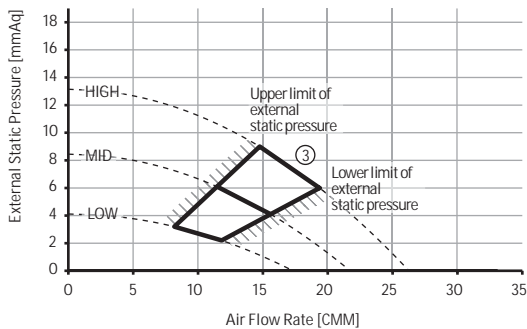

④	External Static Pressure(mmAq)	Option Code
	$9 < SP \leq 12$	010054-1C583B-202D2D-331204

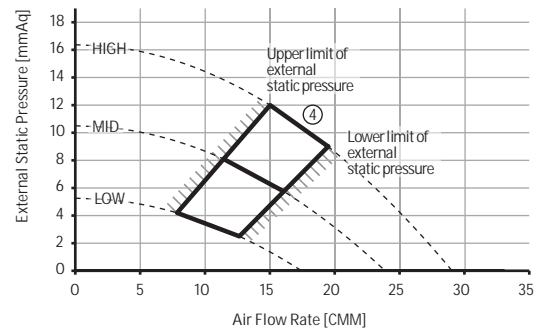

⑤	External Static Pressure(mmAq)	Option Code
	$12 < SP \leq 15$	010054-1C58AF-202D2D-331204

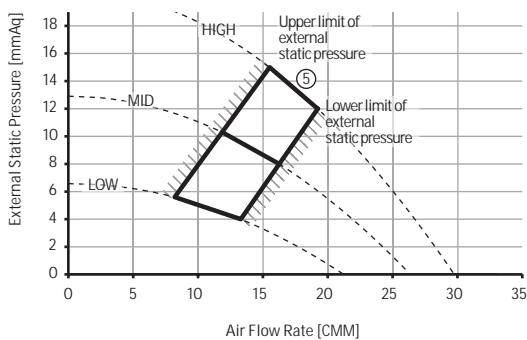

Note

Adjust option code according to the actual installation condition (external static pressure).

ESP = External Static Pressure

The graphs display the available external static pressure range of installed indoor units. Therefore, they do not reflect the actual change of external static pressure and airflow rate according to adjusted airflow (High-Mid-Low) of installed indoor units.

8. Fan Characteristics

3) AM056HNMPKH/EU

①	External Static Pressure(mmAq)	Option Code
	0 < SP ≤ 3	010054-1C50F1-203838-331203

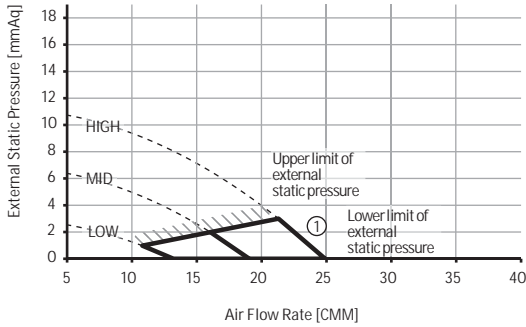

②	External Static Pressure(mmAq)	Option Code
	3 < SP ≤ 6	010054-1C5447-203838-331203

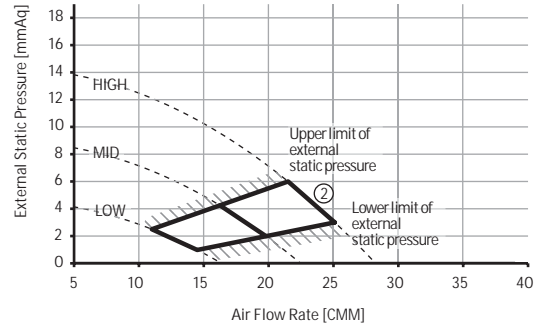

③	External Static Pressure(mmAq)	Option Code
	6 < SP ≤ 9	010054-1C54AB-203838-331203

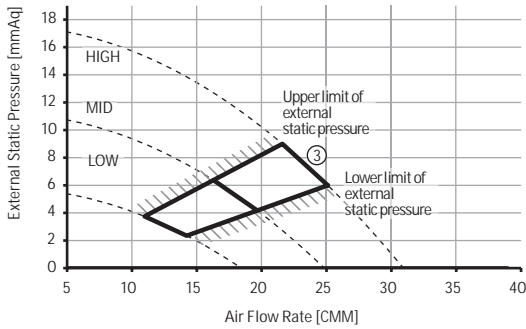

④	External Static Pressure(mmAq)	Option Code
	9 < SP ≤ 12	010054-1C581F-203838-331203

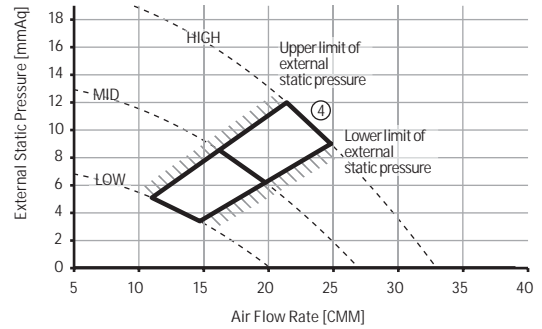

⑤	External Static Pressure(mmAq)	Option Code
	12 < SP ≤ 15	010054-1C5973-203838-331203

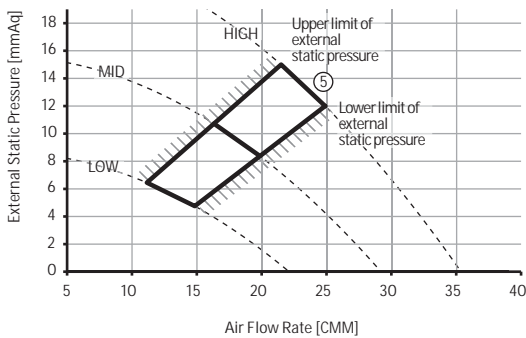

Note

Adjust option code according to the actual installation condition (external static pressure).

ESP = External Static Pressure

The graphs display the available external static pressure range of installed indoor units. Therefore, they do not reflect the actual change of external static pressure and airflow rate according to adjusted airflow (High-Mid-Low) of installed indoor units.

8. Fan Characteristics

4) AM071HNMPKH/EU

①	External Static Pressure(mmAq)	Option Code
	$0 \leq SP \leq 3$	010054-1C548D-204747-331201

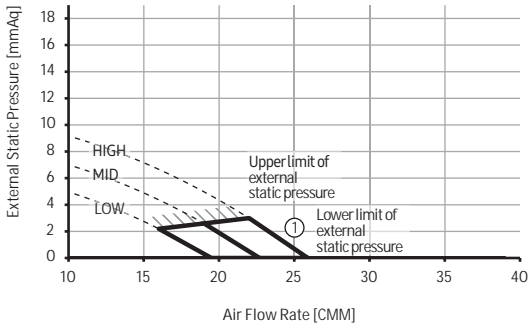

②	External Static Pressure(mmAq)	Option Code
	$3 < SP \leq 6$	010054-1C55E1-204747-331201

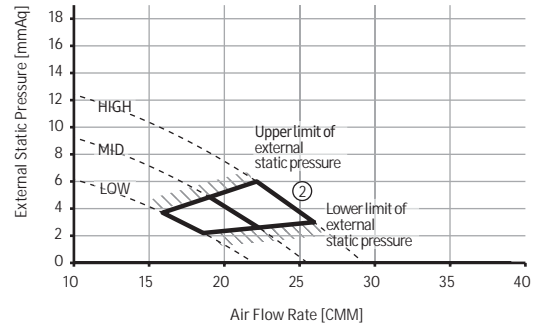

③	External Static Pressure(mmAq)	Option Code
	$6 < SP \leq 9$	010054-1C5935-204747-331201

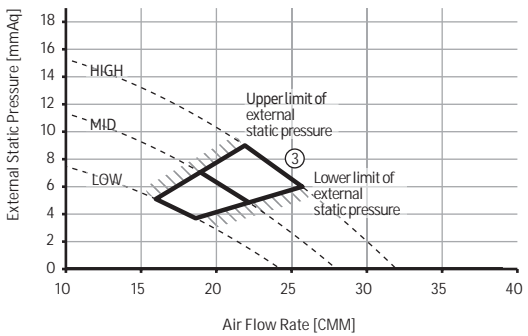

④	External Static Pressure(mmAq)	Option Code
	$9 < SP \leq 12$	010054-1C5989-204747-331201

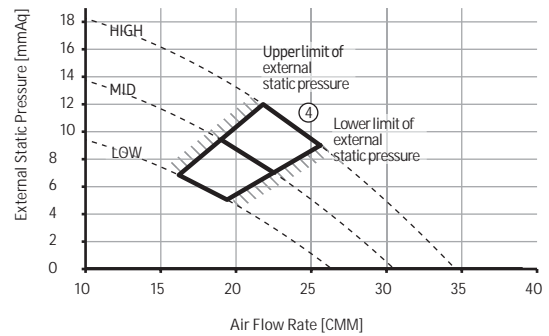

⑤	External Static Pressure(mmAq)	Option Code
	$12 < SP \leq 15$	010054-1C59DF-204747-331201

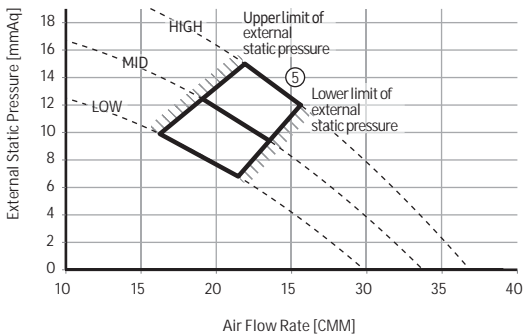

Note

Adjust option code according to the actual installation condition (external static pressure).

ESP = External Static Pressure

The graphs display the available external static pressure range of installed indoor units. Therefore, they do not reflect the actual change of external static pressure and airflow rate according to adjusted airflow (High-Mid-Low) of installed indoor units.

8. Fan Characteristics

5) AM090HNMPKH/EU

①	External Static Pressure(mmAq)	Option Code
	0 ≤ SP ≤ 4	010054-1C546D-205A5A-331212

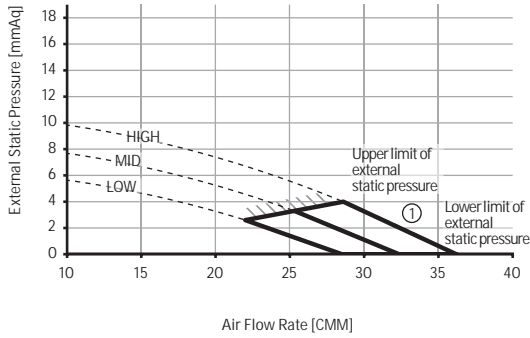

②	External Static Pressure(mmAq)	Option Code
	4 < SP ≤ 8	010054-1C55E3-205A5A-331212

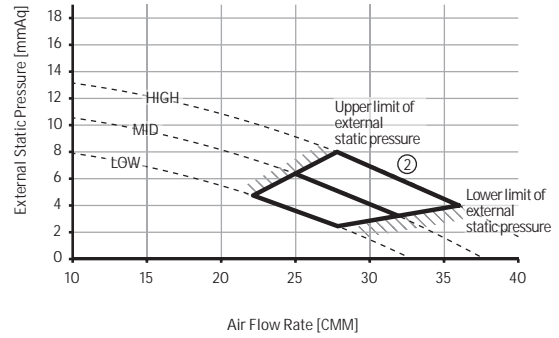

③	External Static Pressure(mmAq)	Option Code
	8 < SP ≤ 12	010054-1C5969-205A5A-331212

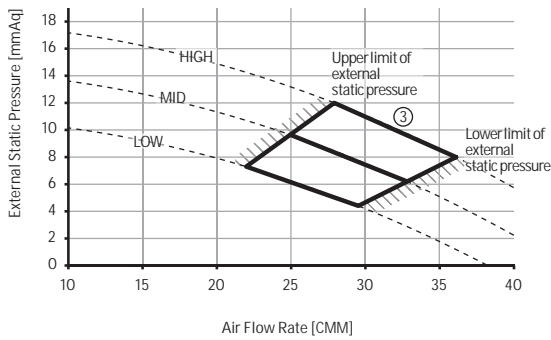

④	External Static Pressure(mmAq)	Option Code
	12 < SP ≤ 15	010054-1C59CD-205A5A-331212

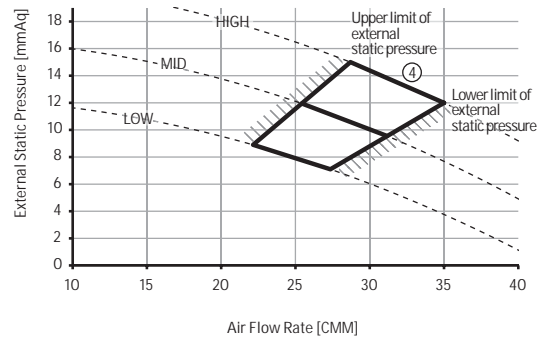

6) AM112HNHPKH/EU

①	External Static Pressure(mmAq)	Option Code
	3 ≤ SP ≤ 6.2	010054-1C5446-207070-331226

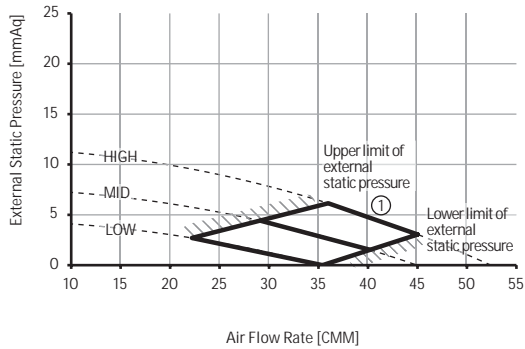

②	External Static Pressure(mmAq)	Option Code
	6.2 < SP ≤ 9	010054-1C54A7-207070-331226

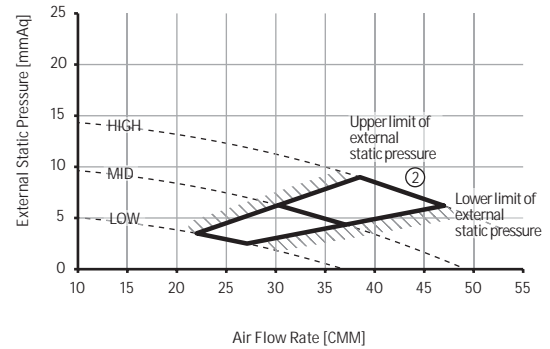

Note

Adjust option code according to the actual installation condition (external static pressure).

ESP = External Static Pressure

The graphs display the available external static pressure range of installed indoor units. Therefore, they do not reflect the actual change of external static pressure and airflow rate according to adjusted airflow (High-Mid-Low) of installed indoor units.

8. Fan Characteristics

6) AM112HNHPKH/EU

③	External Static Pressure(mmAq)	Option Code
	9 < SP≤11	010054-1C54C9-207070-331226

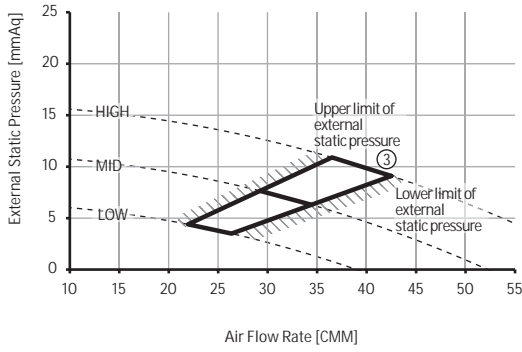

④	External Static Pressure(mmAq)	Option Code
	11 < SP≤13	010054-1C580B-207070-331226

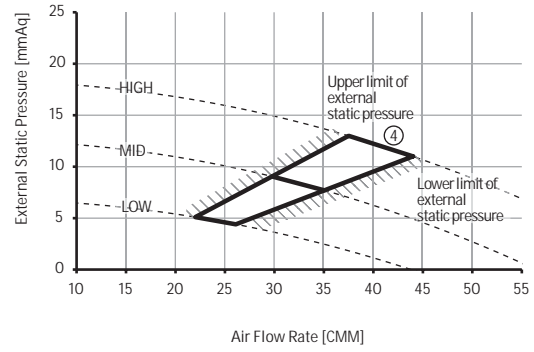

⑤	External Static Pressure(mmAq)	Option Code
	13 < SP≤15	010054-1C584D-207070-331226

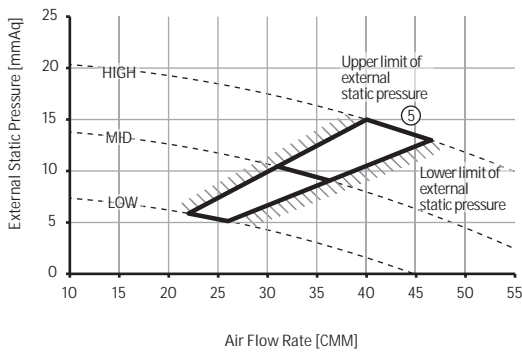

⑥	External Static Pressure(mmAq)	Option Code
	15 < SP≤17	010054-1C587F-207070-331226

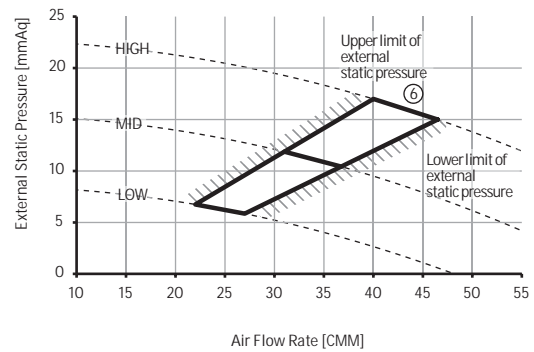

⑦	External Static Pressure(mmAq)	Option Code
	17 < SP≤19	010054-1C59A1-207070-331226

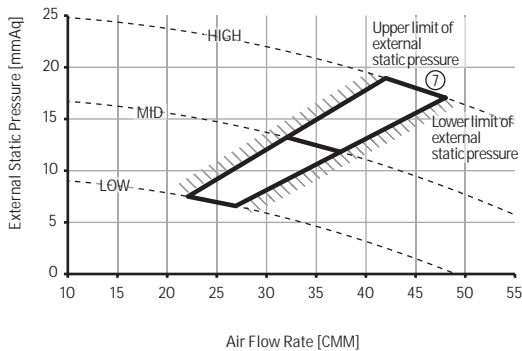

⑧	External Static Pressure(mmAq)	Option Code
	19 < SP≤20	010054-1C59B2-207070-331226

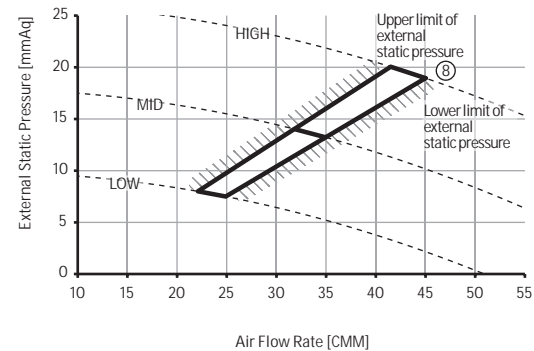

Note

Adjust option code according to the actual installation condition (external static pressure).

ESP = External Static Pressure

The graphs display the available external static pressure range of installed indoor units. Therefore, they do not reflect the actual change of external static pressure and airflow rate according to adjusted airflow (High-Mid-Low) of installed indoor units.

8. Fan Characteristics

7) AM112HNMPKH/EU

①	External Static Pressure(mmAq)	Option Code
	0 ≤ SP ≤ 5.2	010054-1C5412-207070-331223

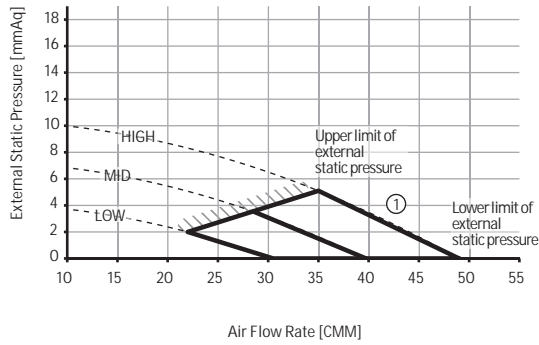

②	External Static Pressure(mmAq)	Option Code
	5.2 < SP ≤ 8	010054-1C5466-207070-331223

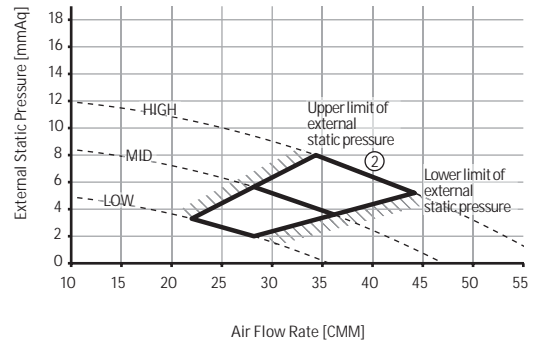

③	External Static Pressure(mmAq)	Option Code
	8 < SP ≤ 12	010054-1C54EA-207070-331223

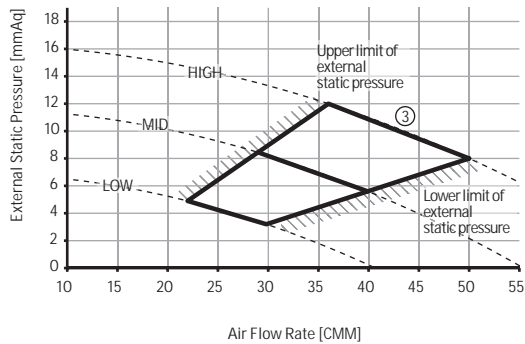

④	External Static Pressure(mmAq)	Option Code
	12 < SP ≤ 15	010054-1C583E-207070-331223

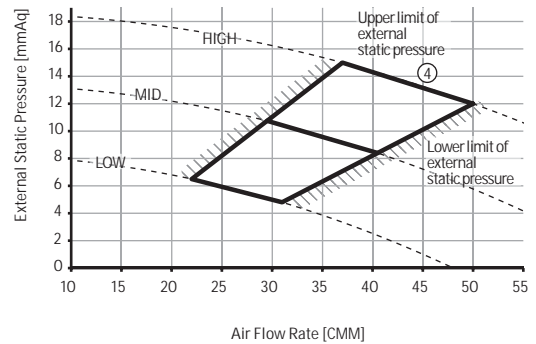

Note

Adjust option code according to the actual installation condition (external static pressure).

ESP = External Static Pressure

The graphs display the available external static pressure range of installed indoor units. Therefore, they do not reflect the actual change of external static pressure and airflow rate according to adjusted airflow (High-Mid-Low) of installed indoor units.

8. Fan Characteristics

8) AM128HNHPKH/EU

①	External Static Pressure(mmAq)	Option Code
	3≤SP≤6.2	010054-1C5466-208080-331225

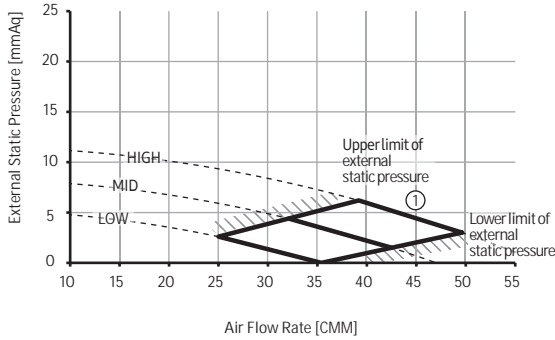

②	External Static Pressure(mmAq)	Option Code
	6.2 < SP ≤ 9	010054-1C54B9-208080-331225

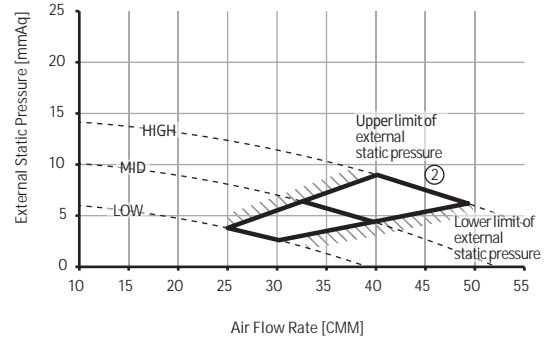

③	External Static Pressure(mmAq)	Option Code
	9 < SP ≤ 11	010054-1C54EC-208080-331225

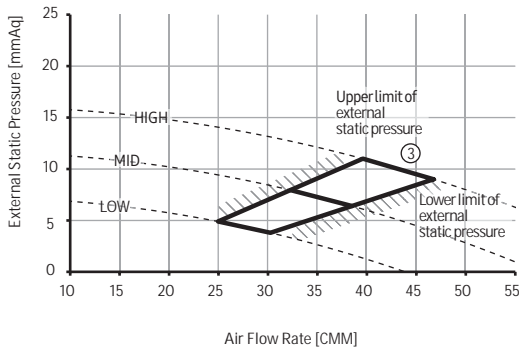

④	External Static Pressure(mmAq)	Option Code
	11 < SP ≤ 13	010054-1C581E-208080-331225

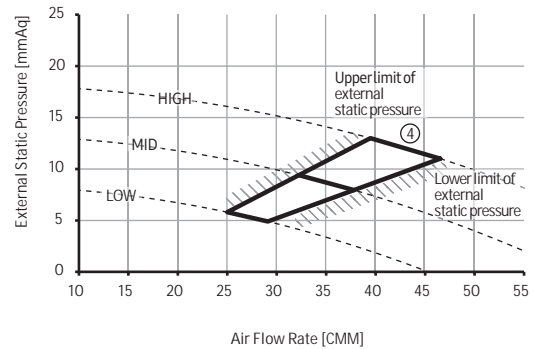

⑤	External Static Pressure(mmAq)	Option Code
	13 < SP ≤ 15	010054-1C5940-208080-331225

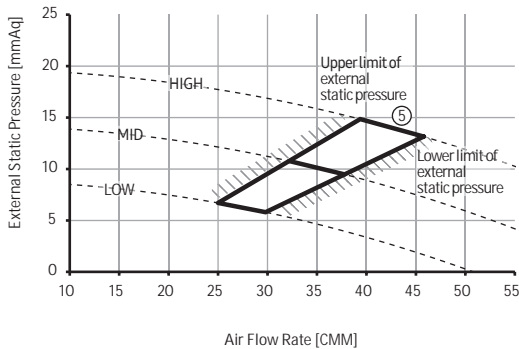

⑥	External Static Pressure(mmAq)	Option Code
	15 < SP ≤ 17	010054-1C5982-208080-331225

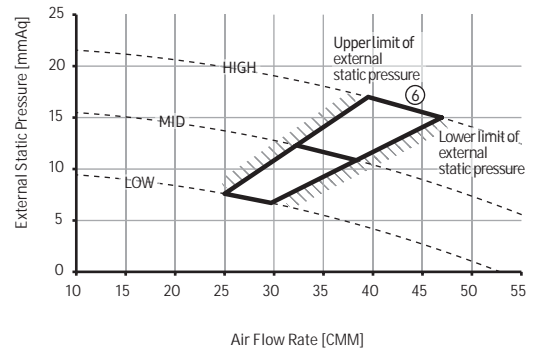

Note

Adjust option code according to the actual installation condition (external static pressure).

ESP = External Static Pressure

The graphs display the available external static pressure range of installed indoor units. Therefore, they do not reflect the actual change of external static pressure and airflow rate according to adjusted airflow (High-Mid-Low) of installed indoor units.

8. Fan Characteristics

8) AM128HNHPKH/EU

⑦	External Static Pressure(mmAq)	Option Code
	17 < SP ≤ 19	010054-1C59B3-208080-331225

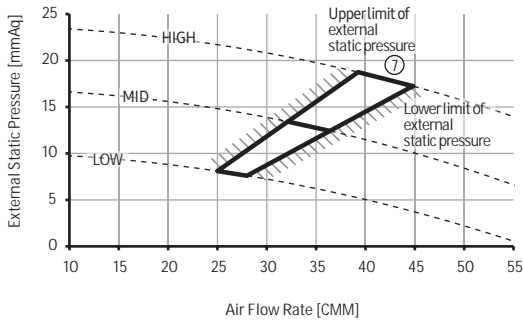

⑧	External Static Pressure(mmAq)	Option Code
	19 < SP ≤ 20	010054-1C59C4-208080-331225

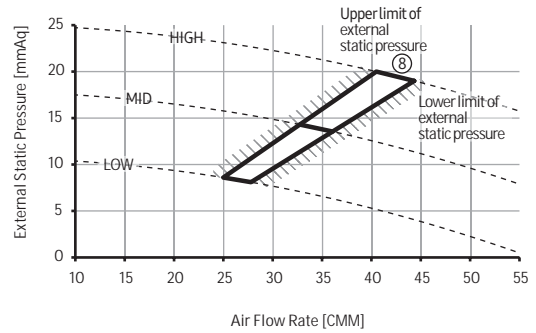

9) AM128HNMPKH/EU

①	External Static Pressure(mmAq)	Option Code
	0 ≤ SP ≤ 5.2	010054-1C5426-208080-331222

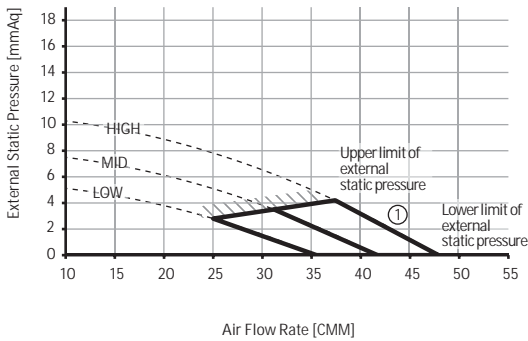

②	External Static Pressure(mmAq)	Option Code
	5.2 < SP ≤ 8	010054-1C5478-208080-331222

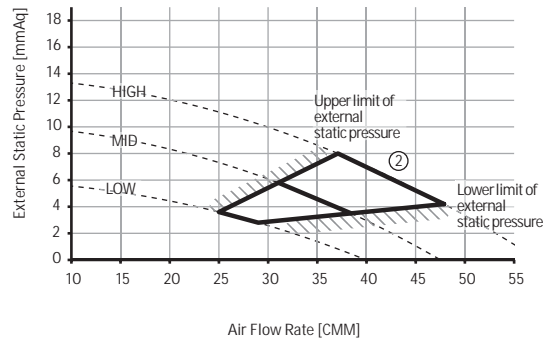

③	External Static Pressure(mmAq)	Option Code
	8 < SP ≤ 12	010054-1C54EE-208080-331222

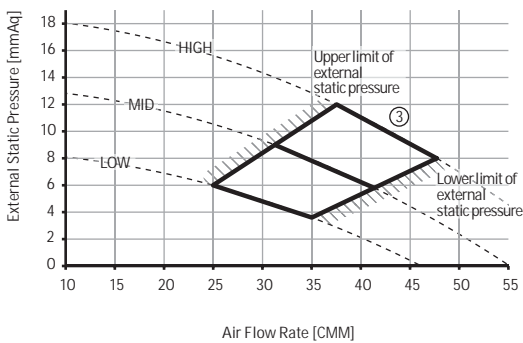

④	External Static Pressure(mmAq)	Option Code
	12 < SP ≤ 15	010054-1C5920-208080-331222

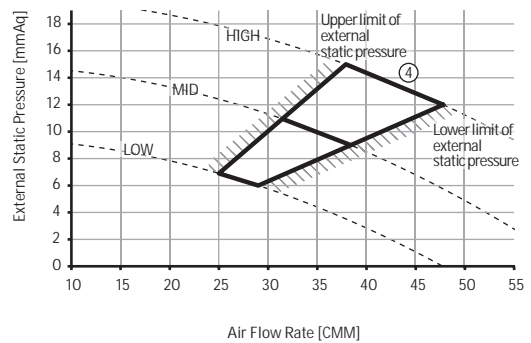

Note

Adjust option code according to the actual installation condition (external static pressure).

ESP = External Static Pressure

The graphs display the available external static pressure range of installed indoor units. Therefore, they do not reflect the actual change of external static pressure and airflow rate according to adjusted airflow (High-Mid-Low) of installed indoor units.

8. Fan Characteristics

10) AM140HNHPKH/EU

①	External Static Pressure(mmAq)	Option Code
	3 ≤ SP ≤ 6.2	010054-1C5486-208C8C-331224

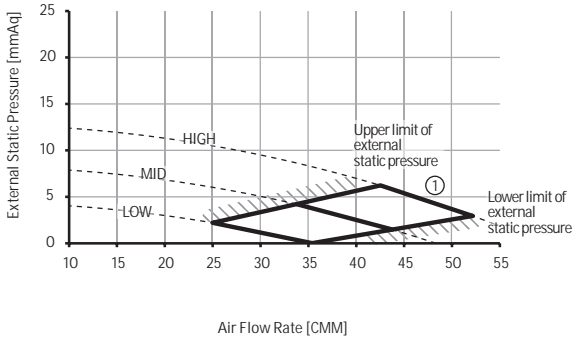

②	External Static Pressure(mmAq)	Option Code
	6.2 < SP ≤ 9	010054-1C54D7-208C8C-331224

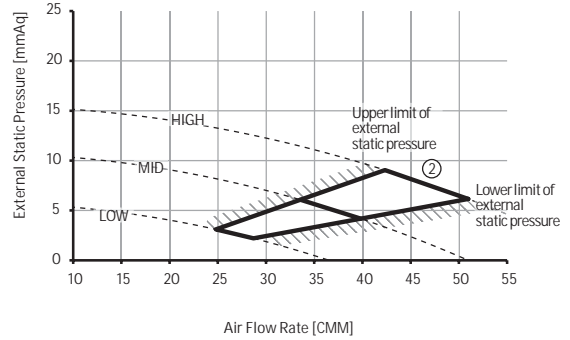

③	External Static Pressure(mmAq)	Option Code
	9 < SP ≤ 11	010054-1C5809-208C8C-331224

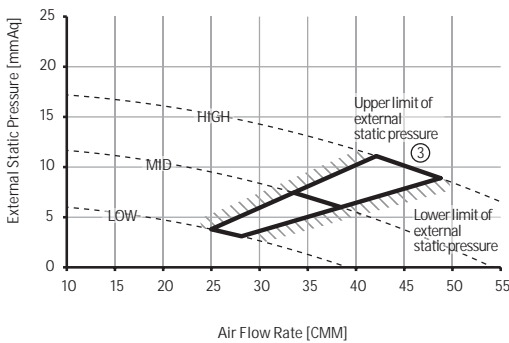

④	External Static Pressure(mmAq)	Option Code
	11 < SP ≤ 13	010054-1C583B-208C8C-331224

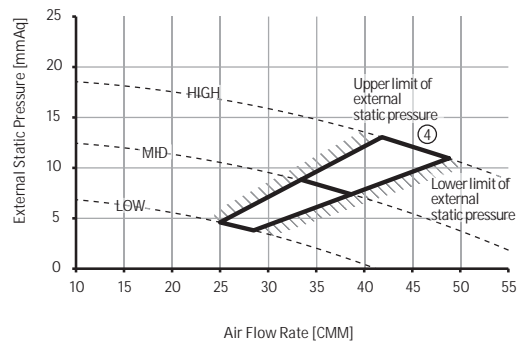

⑤	External Static Pressure(mmAq)	Option Code
	13 < SP ≤ 15	010054-1C586D-208C8C-331224

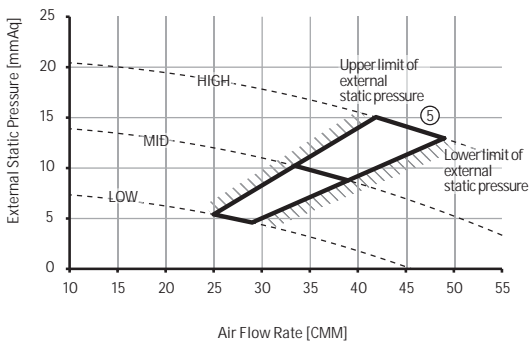

⑥	External Static Pressure(mmAq)	Option Code
	15 < SP ≤ 17	010054-1C588F-208C8C-331224

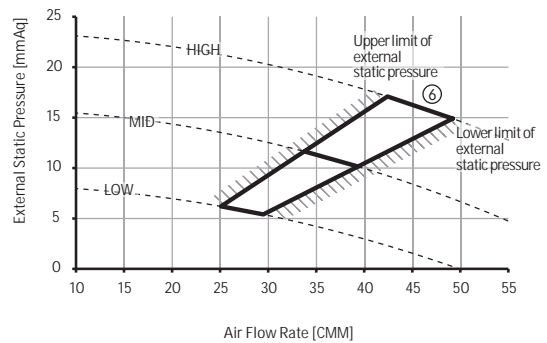

Note

Adjust option code according to the actual installation condition (external static pressure).

ESP = External Static Pressure

The graphs display the available external static pressure range of installed indoor units. Therefore, they do not reflect the actual change of external static pressure and airflow rate according to adjusted airflow (High-Mid-Low) of installed indoor units.

8. Fan Characteristics

10) AM140HNHPKH/EU

⑦	External Static Pressure(mmAq)	Option Code
	17 < SP ≤ 19	010054-1C59C0-208C8C-331224

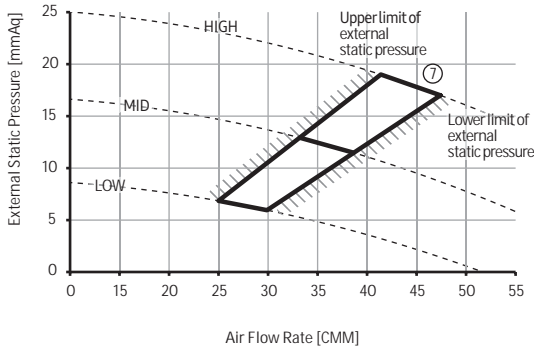

⑧	External Static Pressure(mmAq)	Option Code
	19 < SP ≤ 20	010054-1C59D1-208C8C-331224

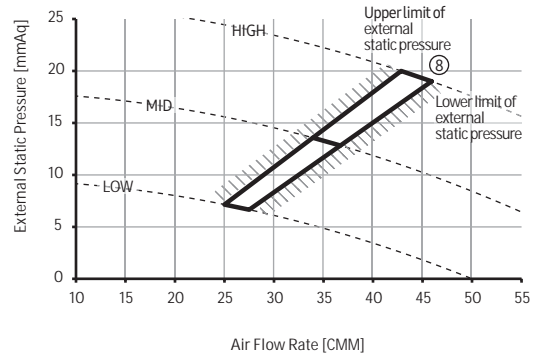

11) AM140HNMPKH/EU

①	External Static Pressure(mmAq)	Option Code
	0 ≤ SP ≤ 5.2	010054-1C5444-208C8C-331221

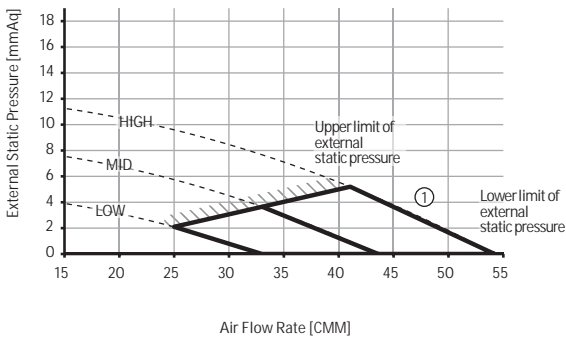

②	External Static Pressure(mmAq)	Option Code
	5.2 < SP ≤ 8	010054-1C5498-208C8C-331221

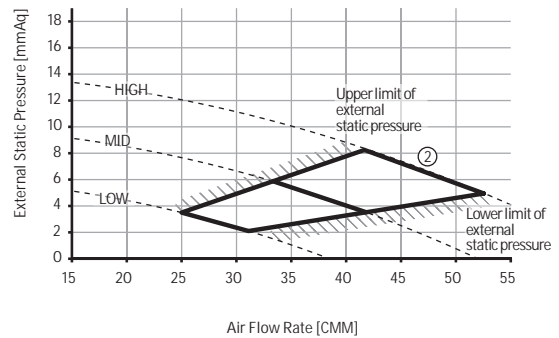

③	External Static Pressure(mmAq)	Option Code
	8 < SP ≤ 12	010054-1C54FA-208C8C-331221

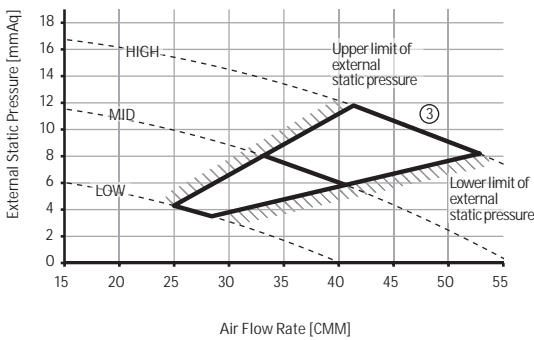

④	External Static Pressure(mmAq)	Option Code
	12 < SP ≤ 15	010054-1C583E-208C8C-331221

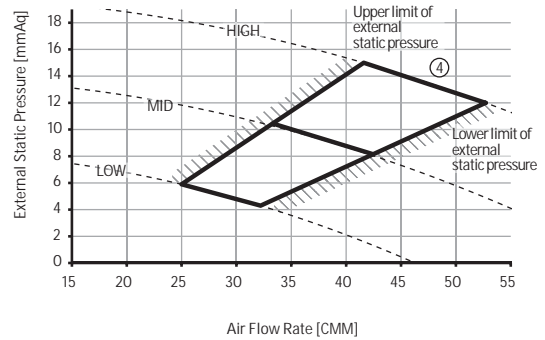

Note

Adjust option code according to the actual installation condition (external static pressure).

ESP = External Static Pressure

The graphs display the available external static pressure range of installed indoor units. Therefore, they do not reflect the actual change of external static pressure and airflow rate according to adjusted airflow (High-Mid-Low) of installed indoor units.

9. Piping Diagram

Duct S

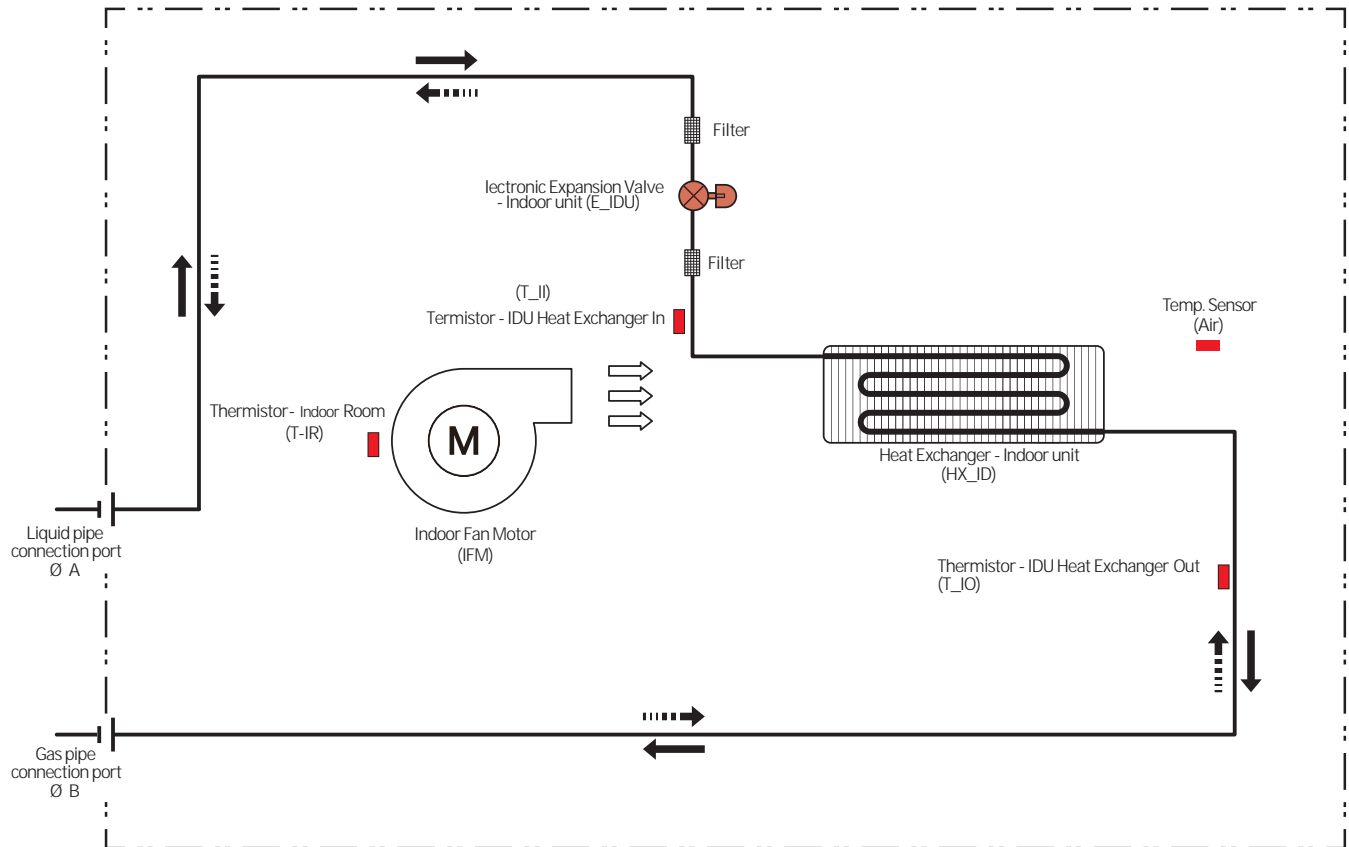

Refrigerant flow	
Cooling	Heating
→	- - - - - →

MODEL	A	B
AM036HNMPKH***	6.35	12.7
AM045HNMPKH***		
AM056HNMPKH***		
AM071HNMPKH***	9.52	15.88
AM090HNMPKH***		
AM112HN*PKH***		
AM128HN*PKH***		
AM140HN*PKH***		

Slim Duct

- 1 *Specifications*
- 2 *Capacity Table*
- 3 *Dimensional Drawing*
- 4 *Electrical Wiring Diagram*
- 5 *Sound Pressure Level*
- 6 *Sound Power Level*
- 7 *Fan Characteristics*

1 Specifications

Slim Duct

Model				AM017FNLDEH/EU	AM022FNLDEH/EU	AM028FNLDEH/EU	AM036FNLDEH/EU	AM045FNLDEH/EU	AM056FNLDEH/EU	
Power Supply		Ø, #, V, Hz		1,2,220-240,50	1,2,220-240,50	1,2,220-240,50	1,2,220-240,50	1,2,220-240,50	1,2,220-240,50	
Mode			-	HP / HR	HP / HR	HP / HR	HP / HR	HP / HR	HP/HR	
Performance	Capacity (Nominal)	Cooling	kW	1.7	2.2	2.8	3.6	4.5	5.6	
			Btu/h	5,800	7,500	9,600	12,300	15,400	19,100	
		Heating	kW	1.9	2.5	3.2	4.0	5.0	6.3	
			Btu/h	6,500	8,500	10,900	13,600	17,100	21,500	
Power	Power Input (Nominal)	Cooling	W	55	55	60	65	90	95	
		Heating	W	55	55	60	65	90	95	
	Current Input (Nominal)	Cooling	A	0.30	0.30	0.32	0.33	0.52	0.53	
		Heating	A	0.30	0.30	0.32	0.33	0.52	0.53	
Fan	Motor	Type	-	Sirocco Fan	Sirocco Fan	Sirocco Fan	Sirocco Fan	Sirocco Fan	Sirocco Fan	
		Output	W	-	-	-	-	-	-	
		Number of unit	EA	1	1	1	1	1	1	
	Air Flow Rate	H/M/L (UL)	CMM		5.5 / 4.3 / 3.2	7.0 / 6.1 / 5.3	7.5 / 6.6 / 5.6	7.5 / 6.6 / 5.6	11.0 / 9.6 / 8.3	12.0 / 10.5 / 9.0
			l/s		91.67/71.67/53.33	116.67/101.67/88.33	125.00/110.00/93.33	125.00/110.00/93.33	183.33/160.00/138.33	200.00/175.00/150.00
	External Static Pressure	Mid/Std/Max	mmAq		0.0 / 1.0 / 3.0	0.0 / 1.0 / 3.0	0.0 / 1.0 / 3.0	0.0 / 1.0 / 3.0	0.0 / 2.0 / 4.0	0.0 / 2.0 / 4.0
			Pa		0.00/9.81/29.42	0.00/9.81/29.42	0.00/9.81/29.42	0.00/9.81/29.42	0.00/19.61/39.23	0.00/19.61/39.23
WG				0/0.039/0.118	0/0.039/0.118	0/0.039/0.118	0/0.039/0.118	0/0.079/0.157	0/0.079/0.157	
Option Code			-	010054-12549E-201111-331110	010054-125AC3-201616-331110	010054-125E15-201C1C-331110	010054-125E68-202424-331110	010054-125AE2-202D2D-331110	010054-125E34-203838-331110	
Piping Connections	Liquid Pipe	Ø, mm		6.35	6.35	6.35	6.35	6.35	6.35	
		Ø, inch		1/4	1/4	1/4	1/4	1/4	1/4	
	Gas Pipe	Ø, mm		12.70	12.70	12.70	12.70	12.70	12.70	
		Ø, inch		1/2	1/2	1/2	1/2	1/2	1/2	
Drain Pipe	Ø, mm		VP25 (OD 32,ID 25)	VP25 (OD 32,ID 25)	VP25 (OD 32,ID 25)	VP25 (OD 32,ID 25)	VP25 (OD 32,ID 25)	VP25 (OD 32,ID 25)		
Field Wiring	Power Source Wire	Below 20m/ over 20m	mm ²	1.5 / 2.5	1.5 / 2.5	1.5 / 2.5	1.5 / 2.5	1.5 / 2.5	1.5 / 2.5	
	Transmission Cable		mm ²	0.75 ~ 1.5	0.75 ~ 1.5	0.75 ~ 1.5	0.75 ~ 1.5	0.75 ~ 1.5	0.75 ~ 1.5	
Refrigerant	Type		-	R410A	R410A	R410A	R410A	R410A	R410A	
	Control Method		-	EEV INCLUDED	EEV INCLUDED	EEV INCLUDED	EEV INCLUDED	EEV INCLUDED	EEV INCLUDED	
Sound	Sound pressure	High / Mid / Low	dBa	23 / 22 / 20	26 / 24 / 21	28 / 26 / 23	32 / 30 / 27	35 / 31 / 26	36 / 34 / 31	
Dimensions	Net Weight		kg	19.0	19.0	19.0	19.5	24.0	24.0	
	Shipping Weight		kg	23.0	23.0	23.0	23.5	29.0	29.0	
	Net Dimensions (WxHxD)		mm	700 x 199 x 600	700 x 199 x 600	700 x 199 x 600	700 x 199 x 600	900 x 199 x 600	900 x 199 x 600	
	Shipping Dimensions (WxHxD)		mm	950 x 270 x 710	950 x 270 x 710	950 x 270 x 710	950 x 270 x 710	1,150 x 280 x 710	1,150 x 280 x 710	
Panel Size	Panel Model		-	-	-	-	-	-	-	
	Net Weight		kg	-	-	-	-	-	-	
	Shipping Weight		kg	-	-	-	-	-	-	
	Net Dimensions (WxHxD)		mm	-	-	-	-	-	-	
Additional Accessories	Drain Pump	Drain Pump	-	MDP-E075SEE3D	MDP-E075SEE3D	MDP-E075SEE3D	MDP-E075SEE3D	MDP-E075SEE3D	MDP-E075SEE3D	
		Max. Lifting Height/ Displacement	mm/liter/h	750 / 24	750 / 24	750 / 24	750 / 24	750 / 24	750 / 24	
	Air Filter		-	Long life filter	Long life filter	Long life filter	Long life filter	Long life filter	Long life filter	

NOTE

- 1) Mode : HP(Heat Pump), HR(Heat Recovery)
 - 2) Nominal Cooling : Indoor temperature 27°CDB / 19°CWB, Outdoor temperature 35°CDB/24°CWB, Refrigerant pipe length 7.5m, Level difference 0m.
 - 3) Nominal Heating : Indoor temperature 20°CDB / 15°CWB, Outdoor temperature 7°CDB / 6°CWB, Refrigerant pipe length 7.5m, Level difference 0m.
 - 4) Sound level was acquired in an anechoic room. Thus actual noise level may be different depending on the installation conditions.
 - 5) These products contain R410A which is fluorinated greenhouse gas.
 - 6) Specifications may be subject to change without prior notice.
- * Heat Exchanger type : Fin & Tube (Fin : Al, Tube : Cu)

1 Specifications

Slim Duct

Model				AM071FNLDEH/EU	AM090FNLDEH/EU	AM112FNLDEH/EU	AM128FNLDEH/EU	AM140FNLDEH/EU	
Power Supply		Ø, #, V, Hz		1,2,220-240,50	1,2,220-240,50	1,2,220-240,50	1,2,220-240,50	1,2,220-240,50	
Mode			-	HP / HR	HP / HR	HP / HR	HP / HR	HP / HR	
Performance	Capacity (Nominal)	Cooling	kW	7.1	9.0	11.2	12.8	14.0	
			Btu/h	24,200	30,700	38,200	43,700	47,800	
		Heating	kW	8.0	10.0	12.5	13.8	16.0	
			Btu/h	27,300	34,100	42,700	47,100	54,600	
Power	Power Input (Nominal)	Cooling	W	120	170	170	200	220	
		Heating	W	120	170	170	200	220	
	Current Input (Nominal)	Cooling	A	0.60	0.96	0.96	1.28	1.43	
		Heating	A	0.60	0.96	0.96	1.28	1.43	
Fan	Motor	Type	-	Sirocco Fan	Sirocco Fan	Sirocco Fan	Sirocco Fan	Sirocco Fan	
		Output	W	-	-	-	-	-	
		Number of unit	EA	1	1	1	1	1	
	Air Flow Rate	H/M/L (UL)	CMM		16.5 / 15.0 / 13.5	29.0 / 27.0 / 25.0	31.2 / 29.0 / 27.0	34.0 / 32.0 / 30.0	36.0 / 34.0 / 32.0
			l/s		275.00/250.00/225.00	483.33/450.00/416.67	520.00/483.33/450.00	566.67/533.33/500.00	600.00/566.67/533.33
	External Static Pressure	Mid/Std/Max	mmAq		0.0 / 2.0 / 4.0	0.0 / 3.0 / 6.0	0.0 / 3.0 / 6.0	0.0 / 3.0 / 6.0	0.0 / 3.0 / 6.0
			Pa		0.00/19.61/39.23	0.00/29.42/58.84	0.00/29.42/58.84	0.00/29.42/58.84	0.00/29.42/58.84
WG				0/0.079/0.157	0/0.118/0.236	0/0.118/0.236	0/0.118/0.236	0/0.118/0.236	
Option Code			-	010054-125D9E-204747-331110	010054-1B5AD4-205A5A-331110	010054-1B5AD4-207070-331110	010054-1B5E4B-208080-331110	010054-1B5E7F-208C8C-331110	
Piping Connections	Liquid Pipe	Ø, mm		9.52	9.52	9.52	9.52	9.52	
		Ø, inch		3/8	3/8	3/8	3/8	3/8	
	Gas Pipe	Ø, mm		15.88	15.88	15.88	15.88	15.88	
		Ø, inch		5/8	5/8	5/8	5/8	5/8	
Drain Pipe	Ø, mm		VP25 (OD 32,ID 25)	VP25 (OD 32,ID 25)	VP25 (OD 32,ID 25)	VP25 (OD 32,ID 25)	VP25 (OD 32,ID 25)		
Field Wiring	Power Source Wire	Below 20m/ over 20m	mm ²	1.5 / 2.5	1.5 / 2.5	1.5 / 2.5	1.5 / 2.5	1.5 / 2.5	
	Transmission Cable		mm ²	0.75~1.5	0.75~1.5	0.75~1.5	0.75~1.5	0.75~1.5	
Refrigerant	Type		-	R410A	R410A	R410A	R410A	R410A	
	Control Method		-	EEV INCLUDED	EEV INCLUDED	EEV INCLUDED	EEV INCLUDED	EEV INCLUDED	
Sound	Sound pressure	High / Mid / Low	dB(A)	38 / 36 / 33	37 / 36 / 34	37 / 36 / 34	37 / 36 / 34	39 / 38 / 36	
Dimensions	Net Weight		kg	30.0	40.0	40.0	41.5	41.5	
	Shipping Weight		kg	34.5	47.0	47.0	48.5	48.5	
	Net Dimensions (WxHxD)		mm	1,100 x 199 x 600	1,300 x 295 x 690	1,300 x 295 x 690	1,300 x 295 x 690	1,300 x 295 x 690	
	Shipping Dimensions (WxHxD)		mm	1,350 x 280 x 710	1,575 x 370 x 835	1,575 x 370 x 835	1,575 x 370 x 835	1,575 x 370 x 835	
Panel Size	Panel Model			-	-	-	-	-	
	Net Weight		kg	-	-	-	-	-	
	Shipping Weight		kg	-	-	-	-	-	
	Net Dimensions (WxHxD)		mm	-	-	-	-	-	
Shipping Dimensions (WxHxD)		mm		-	-	-	-	-	
Additional Accessories	Drain Pump	Drain Pump	-	MDP-E075SEE3D	MDP-E075SEE3D	MDP-E075SEE3D	MDP-E075SEE3D	MDP-E075SEE3D	
		Max. Lifting Height/ Displacement	mm/liter/h	750 / 24	750 / 24	750 / 24	750 / 24	750 / 24	
	Air Filter			-	Long life filter	Long life filter	Long life filter	Long life filter	Long life filter

NOTE

- 1) Mode : HP(Heat Pump), HR(Heat Recovery)
 - 2) Nominal Cooling : Indoor temperature 27°CDB / 19°CWB, Outdoor temperature 35°CDB/24°CWB, Refrigerant pipe length 7.5m, Level difference 0m.
 - 3) Nominal Heating : Indoor temperature 20°CDB / 15°CWB, Outdoor temperature 7°CDB / 6°CWB, Refrigerant pipe length 7.5m, Level difference 0m.
 - 4) Sound level was acquired in an anechoic room. Thus actual noise level may be different depending on the installation conditions.
 - 5) These products contain R410A which is fluorinated greenhouse gas.
 - 6) Specifications may be subject to change without prior notice.
- * Heat Exchanger type : Fin & Tube (Fin : Al, Tube : Cu)

1 Specifications

Slim Duct (Home)

Type				SLIM DUCT	SLIM DUCT
Model				AM017KNLDEH/EU	AM022KNLDEH/EU
Power Supply			Φ, #, V, Hz	1,2,220-240,50	1,2,220-240,50
Mode			-	HP/HR	HP/HR
Performance	Capacity (Nominal)	Cooling	kW	1.7	2.2
			Btu/h	5,800	7,500
		Heating	kW	1.9	2.5
			Btu/h	6,500	8,500
Power	Power Input (Nominal)	Cooling	W	28	30
		Heating		28	30
	Current Input (Nominal)	Cooling	A	0.23	0.25
		Heating		0.23	0.25
Fan	Type		-	Sirocco Fan	Sirocco Fan
	Motor	Output x n	W	69 x 1	69 x 1
	Air Flow Rate	H/M/L (UL)	CMM	5.45 / 4.45 / 3.80	6.00 / 4.90 / 3.80
			l/s	90.83 / 74.17 / 63.33	100 / 81.67 / 63.33
	External Static Pressure	Min / Std / Max	mmAq	0.0 / 1.0 / 3.0	0.0 / 1.0 / 3.0
			Pa	0.00 / 9.81 / 29.42	0.00 / 9.81 / 29.42
Piping Connections	Liquid Pipe		Φ, mm	6.35	6.35
			Φ, inch	1/4"	1/4"
	Gas Pipe		Φ, mm	12.70	12.70
			Φ, inch	1/2"	1/2"
Drain Pipe		Φ, mm	VP25 (OD 32, ID 25)	VP25 (OD 32, ID 25)	
Field Wiring	Power Source Wire		mm ²	1.5 ~ 2.5	1.5 ~ 2.5
	Transmission Cable		mm ²	0.75 ~ 1.50	0.75 ~ 1.50
Refrigerant	Type		-	R410A	R410A
	Control Method		-	EEV INCLUDED	EEV INCLUDED
Sound Data	Sound Pressure Level	High / Mid / Low	dB(A)	25 / 22 / 19	26 / 23 / 19
	Sound Power Level	Cooling		40	42
Dimensions	Net Weight		kg	15.3	15.3
	Shipping Weight		kg	18.2	18.2
	Net Dimensions (WxHxD)		mm	700 x 199 x 440	700 x 199 x 440
	Shipping Dimensions (WxHxD)		mm	949 x 280 x 544	949 x 280 x 544
Panel Size	Panel model		-	-	-
	Panel Net Weight		kg	-	-
	Shipping Weight		kg	-	-
	Net Dimensions (WxHxD)		mm	-	-
	Shipping Dimensions (WxHxD)		mm	-	-
Additional Accessories	Drain pump	Drain pump	-	Drain Pump Included	Drain Pump Included
		Max. lifting Height / Displacement	mm / liter/h	750 / 24	750 / 24
	Air Filter		-	Filter Included	Filter Included

NOTE

- 1) Mode : HP(Heat Pump), HR(Heat Recovery)
 - 2) Nominal Cooling : Indoor temperature 27°CDB / 19°CWB, Outdoor temperature 35°CDB/24°CWB, Refrigerant pipe length 7.5m, Level difference 0m.
 - 3) Nominal Heating : Indoor temperature 20°CDB / 15°CWB, Outdoor temperature 7°CDB / 6°CWB, Refrigerant pipe length 7.5m, Level difference 0m.
 - 4) Sound level was acquired in an anechoic room. Thus actual noise level may be different depending on the installation conditions.
 - 5) These products contain R410A which is fluorinated greenhouse gas.
 - 6) Specifications may be subject to change without prior notice.
- * Heat Exchanger type : Fin & Tube (Fin : Al, Tube : Cu)

1 Specifications

Slim Duct (Home)

Type				SLIM DUCT	SLIM DUCT
Model				AM028KNLDEH/EU	AM036KNLDEH/EU
Power Supply			Φ, #, V, Hz	1,2,220-240,50	1,2,220-240,50
Mode			-	HP/HR	HP/HR
Performance	Capacity (Nominal)	Cooling	kW	2.8	3.6
			Btu/h	9,600	12,300
		Heating	kW	3.2	4.0
			Btu/h	10,900	13,600
Power	Power Input (Nominal)	Cooling	W	34	40
		Heating		36	42
	Current Input (Nominal)	Cooling	A	0.28	0.33
		Heating		0.30	0.35
Fan	Type		-	Sirocco Fan	Sirocco Fan
	Motor	Output x n	W	69 x 1	69 x 1
	Air Flow Rate	H/M/L (UL)	CMM	7.05 / 5.15 / 4.35	8.20 / 6.50 / 4.90
			l/s	117.5 / 85.83 / 72.5	136.67 / 108.33 / 81.67
	External Static Pressure	Min / Std / Max	mmAq	0.0 / 1.0 / 3.0	0.0 / 1.0 / 3.0
			Pa	0.00 / 9.81 / 29.42	0.00 / 9.81 / 29.42
Piping Connections	Liquid Pipe		Φ, mm	6.35	6.35
			Φ, inch	1/4"	1/4"
	Gas Pipe		Φ, mm	12.70	12.70
			Φ, inch	1/2"	1/2"
Drain Pipe		Φ, mm	VP25 (OD 32, ID 25)	VP25 (OD 32, ID 25)	
Field Wiring	Power Source Wire		mm ²	1.5 ~ 2.5	1.5 ~ 2.5
	Transmission Cable		mm ²	0.75 ~ 1.50	0.75 ~ 1.50
Refrigerant	Type		-	R410A	R410A
	Control Method		-	EEV INCLUDED	EEV INCLUDED
Sound Data	Sound Pressure Level	High / Mid / Low	dB(A)	28 / 24 / 19	31 / 26 / 20
	Sound Power Level	Cooling		44	46
Dimensions	Net Weight		kg	15.3	15.7
	Shipping Weight		kg	18.2	18.6
	Net Dimensions (WxHxD)		mm	700 x 199 x 440	700 x 199 x 440
	Shipping Dimensions (WxHxD)		mm	949 x 280 x 544	949 x 280 x 544
Panel Size	Panel model		-	-	-
	Panel Net Weight		kg	-	-
	Shipping Weight		kg	-	-
	Net Dimensions (WxHxD)		mm	-	-
	Shipping Dimensions (WxHxD)		mm	-	-
Additional Accessories	Drain pump	Drain pump	-	Drain Pump Included	Drain Pump Included
		Max. lifting Height / Displacement	mm / liter/h	750 / 24	750 / 24
	Air Filter		-	Filter Included	Filter Included

NOTE

- 1) Mode : HP(Heat Pump), HR(Heat Recovery)
 - 2) Nominal Cooling : Indoor temperature 27°CDB / 19°CWB, Outdoor temperature 35°CDB/24°CWB, Refrigerant pipe length 7.5m, Level difference 0m.
 - 3) Nominal Heating : Indoor temperature 20°CDB / 15°CWB, Outdoor temperature 7°CDB / 6°CWB, Refrigerant pipe length 7.5m, Level difference 0m.
 - 4) Sound level was acquired in an anechoic room. Thus actual noise level may be different depending on the installation conditions.
 - 5) These products contain R410A which is fluorinated greenhouse gas.
 - 6) Specifications may be subject to change without prior notice.
- * Heat Exchanger type : Fin & Tube (Fin : Al, Tube : Cu)

1 Specifications

Slim Duct

Type				SLIM DUCT	SLIM DUCT
Model				AM045KNLDEH/EU	AM056KNLDEH/EU
Power Supply			Φ, #, V, Hz	1,2,220-240,50	1,2,220-240,50
Mode			-	HP/HR	HP/HR
Performance	Capacity (Nominal)	Cooling	kW	4.50	5.60
			Btu/h	15,400	19,100
		Heating	kW	5.00	6.30
			Btu/h	17,100	21,500
Power	Power Input (Nominal)	Cooling	W	90.00	95.00
		Heating		90.00	95.00
	Current Input (Nominal)	Cooling	A	0.52	0.53
		Heating		0.52	0.53
Fan	Type		-	Sirocco Fan	Sirocco Fan
	Motor	Output x n	W	-	-
	Air Flow Rate	H/M/L (UL)	CMM	11.00/9.60/8.30	12.00/10.50/9.00
			l/s	183.33/160.00/138.33	200.00/175.00/150.00
	External Static Pressure	Min / Std / Max	mmAq	0.00/2.00/4.00	0.00/2.00/4.00
			Pa	0.00/19.61/39.23	0.00/19.61/39.23
Piping Connections	Liquid Pipe		Φ, mm	6.35	6.35
			Φ, inch	1/4"	1/4"
	Gas Pipe		Φ, mm	12.70	12.70
			Φ, inch	1/2"	1/2"
Drain Pipe		Φ, mm	VP25 (OD 32, ID 25)	VP25 (OD 32, ID 25)	
Field Wiring	Power Source Wire		mm ²	1.5 ~ 2.5	1.5 ~ 2.5
	Transmission Cable		mm ²	0.75 ~ 1.50	0.75 ~ 1.50
Refrigerant	Type		-	R410A	R410A
	Control Method		-	EEV INCLUDED	EEV INCLUDED
Sound Data	Sound Pressure Level	High / Mid / Low	dB(A)	35 / 31 / 26	36 / 34 / 31
	Sound Power Level	Cooling		53	55
Dimensions	Net Weight		kg	24.5	24.5
	Shipping Weight		kg	29.5	29.5
	Net Dimensions (W×H×D)		mm	900 x 199 x 600	900 x 199 x 600
	Shipping Dimensions (W×H×D)		mm	1150 x 280 x 710	1150 x 280 x 710
Panel Size	Panel model		-	-	-
	Panel Net Weight		kg	-	-
	Shipping Weight		kg	-	-
	Net Dimensions (W×H×D)		mm	-	-
	Shipping Dimensions (W×H×D)		mm	-	-
Additional Accessories	Drain pump	Drain pump	-	Drain Pump Included	Drain Pump Included
		Max. lifting Height / Displacement	mm / liter/h	750 / 24	750 / 24
	Air Filter		-	Filter Included	Filter Included

NOTE

- 1) Mode : HP(Heat Pump), HR(Heat Recovery)
 - 2) Nominal Cooling : Indoor temperature 27°CDB / 19°CWB, Outdoor temperature 35°CDB/24°CWB, Refrigerant pipe length 7.5m, Level difference 0m.
 - 3) Nominal Heating : Indoor temperature 20°CDB / 15°CWB, Outdoor temperature 7°CDB / 6°CWB, Refrigerant pipe length 7.5m, Level difference 0m.
 - 4) Sound level was acquired in an anechoic room. Thus actual noise level may be different depending on the installation conditions.
 - 5) These products contain R410A which is fluorinated greenhouse gas.
 - 6) Specifications may be subject to change without prior notice.
- * Heat Exchanger type : Fin & Tube (Fin : Al, Tube : Cu)

1 Specifications

Slim Duct

Type				SLIM DUCT	SLIM DUCT
Model				AM071KNLDEH/EU	AM090KNLDEH/EU
Power Supply			Φ, #, V, Hz	1,2,220-240,50	1,2,220-240,50
Mode			-	HP/HR	HP/HR
Performance	Capacity (Nominal)	Cooling	kW	7.10	9.00
			Btu/h	24,200	30,700
		Heating	kW	8.00	10.00
			Btu/h	27,300	34,100
Power	Power Input (Nominal)	Cooling	W	120.00	170.00
		Heating		120.00	170.00
	Current Input (Nominal)	Cooling	A	0.60	0.96
		Heating		0.60	0.96
Fan	Type		-	Sirocco Fan	Sirocco Fan
	Motor	Output x n	W	-	-
	Air Flow Rate	H/M/L (UL)	CMM	16.50/15.00/13.50	29.00/27.00/25.00
			l/s	275.00/250.00/225.00	483.33/450.00/416.67
	External Static Pressure	Min / Std / Max	mmAq	0.00/2.00/4.00	0.00/3.00/6.00
			Pa	0.00/19.61/39.23	0.00/29.42/58.84
Piping Connections	Liquid Pipe		Φ, mm	9.52	9.52
			Φ, inch	3/8"	3/8"
	Gas Pipe		Φ, mm	15.88	15.88
			Φ, inch	5/8"	5/8"
Drain Pipe		Φ, mm	VP25 (OD 32, ID 25)	VP25 (OD 32, ID 25)	
Field Wiring	Power Source Wire		mm ²	1.5 ~ 2.5	1.5 ~ 2.5
	Transmission Cable		mm ²	0.75 ~ 1.50	0.75 ~ 1.50
Refrigerant	Type		-	R410A	R410A
	Control Method		-	EEV INCLUDED	EEV INCLUDED
Sound Data	Sound Pressure Level	High / Mid / Low	dB(A)	38 / 36 / 33	37 / 36 / 34
	Sound Power Level	Cooling		57	66
Dimensions	Net Weight		kg	30.5	40.5
	Shipping Weight		kg	35.5	48.0
	Net Dimensions (WxHxD)		mm	1100 x 199 x 600	1300 x 295 x 690
	Shipping Dimensions (WxHxD)		mm	1350 x 280 x 710	1575 x 370 x 835
Panel Size	Panel model		-	-	-
	Panel Net Weight		kg	-	-
	Shipping Weight		kg	-	-
	Net Dimensions (WxHxD)		mm	-	-
	Shipping Dimensions (WxHxD)		mm	-	-
Additional Accessories	Drain pump	Drain pump	-	Drain Pump Included	Drain Pump Included
		Max. lifting Height / Displacement	mm / liter/h	750 / 24	750 / 24
	Air Filter		-	Filter Included	Filter Included

NOTE

- 1) Mode : HP(Heat Pump), HR(Heat Recovery)
 - 2) Nominal Cooling : Indoor temperature 27°CDB / 19°CWB, Outdoor temperature 35°CDB/24°CWB, Refrigerant pipe length 7.5m, Level difference 0m.
 - 3) Nominal Heating : Indoor temperature 20°CDB / 15°CWB, Outdoor temperature 7°CDB / 6°CWB, Refrigerant pipe length 7.5m, Level difference 0m.
 - 4) Sound level was acquired in an anechoic room. Thus actual noise level may be different depending on the installation conditions.
 - 5) These products contain R410A which is fluorinated greenhouse gas.
 - 6) Specifications may be subject to change without prior notice.
- * Heat Exchanger type : Fin & Tube (Fin : Al, Tube : Cu)

1 Specifications

Slim Duct

Type				SLIM DUCT	SLIM DUCT	SLIM DUCT
Model				AM112KNLDEH/EU	AM128KNLDEH/EU	AM140KNLDEH/EU
Power Supply			Φ, #, V, Hz	1,2,220-240,50	1,2,220-240,50	1,2,220-240,50
Mode			-	HP/HR	HP/HR	HP/HR
Performance	Capacity (Nominal)	Cooling	kW	11.20	12.80	14.00
			Btu/h	38,200	43,700	47,800
		Heating	kW	12.50	13.80	16.00
			Btu/h	42,700	47,100	54,600
Power	Power Input (Nominal)	Cooling	W	170.00	200.00	220.00
		Heating		170.00	200.00	220.00
	Current Input (Nominal)	Cooling	A	0.96	1.28	1.43
		Heating		0.96	1.28	1.43
Fan	Type	-		Sirocco Fan	Sirocco Fan	Sirocco Fan
	Motor	Output x n	W	-	-	-
	Air Flow Rate	H/M/L (UL)	CMM	31.20/29.00/27.00	34.00/32.00/30.00	36.00/34.00/32.00
			l/s	520.00/483.33/450.00	566.67/533.33/500.00	600.00/566.67/533.33
	External Static Pressure	Min / Std / Max	mmAq	0.00/3.00/6.00	0.00/3.00/6.00	0.00/3.00/6.00
			Pa	0.00/29.42/58.84	0.00/29.42/58.84	0.00/29.42/58.84
Piping Connections	Liquid Pipe	Φ,mm	9.52	9.52	9.52	
		Φ, inch	3/8"	3/8"	3/8"	
	Gas Pipe	Φ,mm	15.88	15.88	15.88	
		Φ, inch	5/8"	5/8"	5/8"	
Drain Pipe	Φ,mm	VP25 (OD 32,ID 25)	VP25 (OD 32,ID 25)	VP25 (OD 32,ID 25)		
Field Wiring	Power Source Wire	mm ²		1.5 ~ 2.5	1.5 ~ 2.5	1.5 ~ 2.5
	Transmission Cable	mm ²		0.75 ~ 1.50	0.75 ~ 1.50	0.75 ~ 1.50
Refrigerant	Type	-		R410A	R410A	R410A
	Control Method	-		EEV INCLUDED	EEV INCLUDED	EEV INCLUDED
Sound Data	Sound Pressure Level	High / Mid / Low	dB(A)	37 / 36 / 34	37 / 36 / 34	39 / 38 / 36
	Sound Power Level	Cooling		66	66	68
Dimensions	Net Weight		kg	40.5	42.0	42.0
	Shipping Weight		kg	48.0	49.5	49.5
	Net Dimensions (W×H×D)		mm	1300 x 295 x 690	1300 x 295 x 690	1300 x 295 x 690
	Shipping Dimensions (W×H×D)		mm	1575 x 370 x 835	1575 x 370 x 835	1575 x 370 x 835
Panel Size	Panel model		-	-	-	-
	Panel Net Weight		kg	-	-	-
	Shipping Weight		kg	-	-	-
	Net Dimensions (W×H×D)		mm	-	-	-
	Shipping Dimensions (W×H×D)		mm	-	-	-
Additional Accessories	Drain pump	Drain pump	-	Drain Pump Included	Drain Pump Included	Drain Pump Included
		Max. lifting Height / Displacement	mm / liter/h	750 / 24	750 / 24	750 / 24
	Air Filter		-	Filter Included	Filter Included	Filter Included

NOTE

- 1) Mode : HP(Heat Pump), HR(Heat Recovery)
 - 2) Nominal Cooling : Indoor temperature 27°CDB / 19°CWB, Outdoor temperature 35°CDB/24°CWB, Refrigerant pipe length 7.5m, Level difference 0m.
 - 3) Nominal Heating : Indoor temperature 20°CDB / 15°CWB, Outdoor temperature 7°CDB / 6°CWB, Refrigerant pipe length 7.5m, Level difference 0m.
 - 4) Sound level was acquired in an anechoic room. Thus actual noise level may be different depending on the installation conditions.
 - 5) These products contain R410A which is fluorinated greenhouse gas.
 - 6) Specifications may be subject to change without prior notice.
- * Heat Exchanger type : Fin & Tube (Fin : Al, Tube : Cu)

2 Capacity Table

Slim Duct

Cooling

TC : Total Capacity(kW), SHC : Sensible Heat Capacity(kW)

Capacity Index	Outdoor Air Temp. (°C,DB)	Indoor temperature													
		20(°C,DB)		23(°C,DB)		26(°C,DB)		27(°C,DB)		28(°C,DB)		30(°C,DB)		32(°C,DB)	
		14(°C,WB)		16(°C,WB)		18(°C,WB)		19(°C,WB)		20(°C,WB)		22(°C,WB)		24(°C,WB)	
		TC	SHC	TC	SHC	TC	SHC	TC	SHC	TC	SHC	TC	SHC	TC	SHC
017	10	1.2	1.0	1.4	1.2	1.6	1.3	1.7	1.3	1.8	1.3	1.9	1.4	2.0	1.2
	12	1.2	1.0	1.4	1.2	1.6	1.3	1.7	1.3	1.8	1.3	1.9	1.4	2.0	1.2
	14	1.2	1.0	1.4	1.2	1.6	1.3	1.7	1.3	1.8	1.3	1.9	1.4	2.0	1.2
	16	1.2	1.0	1.4	1.2	1.6	1.3	1.7	1.3	1.8	1.3	1.9	1.3	2.0	1.2
	18	1.2	1.0	1.4	1.2	1.6	1.3	1.7	1.3	1.8	1.3	1.9	1.3	2.0	1.2
	20	1.2	1.0	1.4	1.2	1.6	1.3	1.7	1.3	1.8	1.3	1.9	1.3	2.0	1.2
	21	1.2	1.0	1.4	1.2	1.6	1.3	1.7	1.3	1.8	1.3	1.9	1.3	2.0	1.2
	23	1.2	1.0	1.4	1.2	1.6	1.3	1.7	1.3	1.8	1.3	1.9	1.3	2.0	1.2
	25	1.2	1.0	1.4	1.2	1.6	1.3	1.7	1.3	1.8	1.3	1.9	1.3	2.0	1.2
	27	1.2	1.0	1.4	1.2	1.6	1.3	1.7	1.3	1.8	1.3	1.9	1.3	2.0	1.2
	29	1.2	1.0	1.4	1.2	1.6	1.3	1.7	1.3	1.8	1.3	1.9	1.3	2.0	1.2
	31	1.2	1.0	1.4	1.2	1.6	1.3	1.7	1.3	1.8	1.3	1.9	1.3	2.0	1.2
	33	1.2	1.0	1.4	1.2	1.6	1.3	1.7	1.3	1.8	1.3	1.9	1.3	2.0	1.2
	35	1.2	1.0	1.4	1.2	1.6	1.3	1.7	1.3	1.8	1.3	1.9	1.3	2.0	1.2
	37	1.2	1.0	1.4	1.2	1.6	1.3	1.7	1.3	1.8	1.3	1.9	1.3	2.0	1.2
39	1.2	1.0	1.4	1.2	1.6	1.3	1.7	1.3	1.8	1.3	1.9	1.3	1.9	1.2	
42	1.2	1.0	1.4	1.2	1.6	1.3	1.7	1.3	1.8	1.3	1.9	1.3	1.9	1.2	
44	1.2	1.0	1.4	1.2	1.5	1.3	1.6	1.2	1.7	1.2	1.8	1.2	1.8	1.1	
46	1.2	1.0	1.4	1.2	1.5	1.2	1.6	1.2	1.7	1.2	1.7	1.2	1.7	1.1	
48	1.2	1.0	1.4	1.2	1.5	1.2	1.5	1.2	1.6	1.2	1.7	1.2	1.7	1.1	
022	10	1.5	1.2	1.8	1.4	2.1	1.6	2.2	1.6	2.3	1.6	2.5	1.7	2.6	1.5
	12	1.5	1.2	1.8	1.4	2.1	1.6	2.2	1.6	2.3	1.6	2.5	1.7	2.6	1.5
	14	1.5	1.2	1.8	1.4	2.1	1.6	2.2	1.6	2.3	1.6	2.5	1.7	2.6	1.5
	16	1.5	1.2	1.8	1.4	2.1	1.6	2.2	1.6	2.3	1.6	2.4	1.6	2.6	1.5
	18	1.5	1.2	1.8	1.4	2.1	1.6	2.2	1.6	2.3	1.6	2.4	1.6	2.6	1.5
	20	1.5	1.2	1.8	1.4	2.1	1.6	2.2	1.6	2.3	1.6	2.4	1.6	2.6	1.5
	21	1.5	1.2	1.8	1.4	2.1	1.6	2.2	1.6	2.3	1.6	2.4	1.6	2.6	1.5
	23	1.5	1.2	1.8	1.4	2.1	1.6	2.2	1.6	2.3	1.6	2.4	1.6	2.6	1.5
	25	1.5	1.2	1.8	1.4	2.1	1.6	2.2	1.6	2.3	1.6	2.4	1.6	2.6	1.5
	27	1.5	1.2	1.8	1.4	2.1	1.6	2.2	1.6	2.3	1.6	2.4	1.6	2.6	1.5
	29	1.5	1.2	1.8	1.4	2.1	1.6	2.2	1.6	2.3	1.6	2.4	1.6	2.6	1.5
	31	1.5	1.2	1.8	1.4	2.1	1.6	2.2	1.6	2.3	1.6	2.4	1.6	2.6	1.5
	33	1.5	1.2	1.8	1.4	2.1	1.6	2.2	1.6	2.3	1.6	2.4	1.6	2.6	1.5
	35	1.5	1.2	1.8	1.4	2.1	1.6	2.2	1.6	2.3	1.6	2.4	1.6	2.6	1.5
	37	1.5	1.2	1.8	1.4	2.1	1.6	2.2	1.6	2.3	1.6	2.4	1.6	2.6	1.5
39	1.5	1.2	1.8	1.4	2.1	1.6	2.2	1.6	2.3	1.6	2.4	1.6	2.5	1.4	
42	1.5	1.2	1.8	1.4	2.1	1.6	2.2	1.6	2.3	1.6	2.4	1.6	2.4	1.4	
44	1.5	1.2	1.8	1.4	2.0	1.5	2.1	1.5	2.2	1.5	2.3	1.5	2.4	1.3	
46	1.5	1.2	1.8	1.4	2.0	1.5	2.0	1.5	2.1	1.5	2.2	1.5	2.3	1.3	
48	1.5	1.2	1.8	1.4	2.0	1.5	2.0	1.4	2.1	1.5	2.1	1.4	2.2	1.2	
028	10	1.9	1.6	2.3	1.8	2.6	1.9	2.8	2.0	2.9	2.0	3.1	2.0	3.4	2.0
	12	1.9	1.6	2.3	1.8	2.6	1.9	2.8	2.0	2.9	2.0	3.1	2.0	3.3	1.9
	14	1.9	1.6	2.3	1.8	2.6	1.9	2.8	2.0	2.9	2.0	3.1	2.0	3.3	1.9
	16	1.9	1.6	2.3	1.8	2.6	1.9	2.8	2.0	2.9	2.0	3.1	2.0	3.3	1.9
	18	1.9	1.6	2.3	1.8	2.6	1.9	2.8	2.0	2.9	2.0	3.1	2.0	3.3	1.9
	20	1.9	1.6	2.3	1.8	2.6	1.9	2.8	2.0	2.9	2.0	3.1	2.0	3.3	1.9
	21	1.9	1.6	2.3	1.8	2.6	1.9	2.8	2.0	2.9	2.0	3.1	2.0	3.3	1.9
	23	1.9	1.6	2.3	1.8	2.6	1.9	2.8	2.0	2.9	2.0	3.1	2.0	3.3	1.9
	25	1.9	1.6	2.3	1.8	2.6	1.9	2.8	2.0	2.9	2.0	3.1	2.0	3.3	1.9
	27	1.9	1.6	2.3	1.8	2.6	1.9	2.8	2.0	2.9	2.0	3.1	2.0	3.3	1.9
	29	1.9	1.6	2.3	1.8	2.6	1.9	2.8	2.0	2.9	2.0	3.1	2.0	3.3	1.9
	31	1.9	1.6	2.3	1.8	2.6	1.9	2.8	2.0	2.9	2.0	3.1	2.0	3.3	1.9
	33	1.9	1.6	2.3	1.8	2.6	1.9	2.8	2.0	2.9	2.0	3.1	2.0	3.3	1.9
	35	1.9	1.6	2.3	1.8	2.6	1.9	2.8	2.0	2.9	2.0	3.1	2.0	3.3	1.9
	37	1.9	1.6	2.3	1.8	2.6	1.9	2.8	2.0	2.9	2.0	3.1	2.0	3.3	1.9
39	1.9	1.6	2.3	1.8	2.6	1.9	2.8	2.0	2.9	2.0	3.0	1.9	3.2	1.8	
42	1.9	1.6	2.3	1.8	2.6	1.9	2.8	2.0	2.9	2.0	2.9	1.9	3.1	1.8	
44	1.9	1.6	2.3	1.8	2.5	1.8	2.7	1.9	2.8	1.9	2.8	1.8	3.0	1.7	
46	1.9	1.6	2.3	1.8	2.5	1.8	2.6	1.8	2.7	1.9	2.7	1.7	2.9	1.6	
48	1.9	1.6	2.2	1.8	2.4	1.8	2.5	1.8	2.6	1.8	2.7	1.7	2.8	1.6	

2 Capacity Table

Slim Duct

Cooling

TC : Total Capacity(kW), SHC : Sensible Heat Capacity(kW)

Capacity Index	Outdoor Air Temp. (°C, DB)	Indoor temperature													
		20(°C, DB)		23(°C, DB)		26(°C, DB)		27(°C, DB)		28(°C, DB)		30(°C, DB)		32(°C, DB)	
		14(°C, WB)		16(°C, WB)		18(°C, WB)		19(°C, WB)		20(°C, WB)		22(°C, WB)		24(°C, WB)	
		TC	SHC	TC	SHC	TC	SHC	TC	SHC	TC	SHC	TC	SHC	TC	SHC
036	10	2.5	2.0	2.9	2.3	3.4	2.5	3.6	2.6	3.7	2.6	4.0	2.6	4.3	2.5
	12	2.5	2.0	2.9	2.3	3.4	2.5	3.6	2.6	3.7	2.6	4.0	2.6	4.3	2.5
	14	2.5	2.0	2.9	2.3	3.4	2.5	3.6	2.6	3.7	2.6	4.0	2.6	4.3	2.5
	16	2.5	2.0	2.9	2.3	3.4	2.5	3.6	2.6	3.7	2.6	4.0	2.6	4.3	2.5
	18	2.5	2.0	2.9	2.3	3.4	2.5	3.6	2.6	3.7	2.6	4.0	2.6	4.2	2.4
	20	2.5	2.0	2.9	2.3	3.4	2.5	3.6	2.6	3.7	2.6	4.0	2.6	4.2	2.4
	21	2.5	2.0	2.9	2.3	3.4	2.5	3.6	2.6	3.7	2.6	4.0	2.6	4.2	2.4
	23	2.5	2.0	2.9	2.3	3.4	2.5	3.6	2.6	3.7	2.6	4.0	2.6	4.2	2.4
	25	2.5	2.0	2.9	2.3	3.4	2.5	3.6	2.6	3.7	2.6	4.0	2.6	4.2	2.4
	27	2.5	2.0	2.9	2.3	3.4	2.5	3.6	2.6	3.7	2.6	4.0	2.6	4.2	2.4
	29	2.5	2.0	2.9	2.3	3.4	2.5	3.6	2.6	3.7	2.6	4.0	2.6	4.2	2.4
	31	2.5	2.0	2.9	2.3	3.4	2.5	3.6	2.6	3.7	2.6	4.0	2.6	4.2	2.4
	33	2.5	2.0	2.9	2.3	3.4	2.5	3.6	2.6	3.7	2.6	4.0	2.6	4.2	2.4
	35	2.5	2.0	2.9	2.3	3.4	2.5	3.6	2.6	3.7	2.6	4.0	2.6	4.2	2.4
	37	2.5	2.0	2.9	2.3	3.4	2.5	3.6	2.6	3.7	2.6	3.9	2.5	4.2	2.4
39	2.5	2.0	2.9	2.3	3.4	2.5	3.6	2.6	3.7	2.6	3.9	2.5	4.1	2.3	
42	2.5	2.0	2.9	2.3	3.4	2.5	3.6	2.6	3.7	2.6	3.8	2.5	4.0	2.2	
44	2.5	2.0	2.9	2.3	3.3	2.4	3.4	2.5	3.6	2.5	3.7	2.4	3.9	2.2	
46	2.5	2.0	2.9	2.3	3.2	2.4	3.3	2.4	3.4	2.4	3.6	2.3	3.8	2.1	
48	2.5	2.0	2.8	2.2	3.2	2.3	3.2	2.3	3.4	2.4	3.5	2.2	3.6	2.0	
045	10	3.1	2.7	3.7	3.1	4.2	3.2	4.5	3.3	4.7	3.3	5.0	3.3	5.4	3.4
	12	3.1	2.7	3.7	3.1	4.2	3.2	4.5	3.3	4.7	3.3	5.0	3.3	5.4	3.4
	14	3.1	2.7	3.7	3.1	4.2	3.2	4.5	3.3	4.7	3.3	5.0	3.3	5.4	3.4
	16	3.1	2.7	3.7	3.1	4.2	3.2	4.5	3.3	4.7	3.3	5.0	3.3	5.3	3.1
	18	3.1	2.7	3.7	3.1	4.2	3.2	4.5	3.3	4.7	3.3	5.0	3.3	5.3	3.1
	20	3.1	2.7	3.7	3.1	4.2	3.2	4.5	3.3	4.7	3.3	5.0	3.3	5.3	3.1
	21	3.1	2.7	3.7	3.1	4.2	3.2	4.5	3.3	4.7	3.3	5.0	3.3	5.3	3.1
	23	3.1	2.7	3.7	3.1	4.2	3.2	4.5	3.3	4.7	3.3	5.0	3.3	5.3	3.1
	25	3.1	2.7	3.7	3.1	4.2	3.2	4.5	3.3	4.7	3.3	5.0	3.3	5.3	3.1
	27	3.1	2.7	3.7	3.1	4.2	3.2	4.5	3.3	4.7	3.3	5.0	3.3	5.3	3.1
	29	3.1	2.7	3.7	3.1	4.2	3.2	4.5	3.3	4.7	3.3	5.0	3.3	5.3	3.1
	31	3.1	2.7	3.7	3.1	4.2	3.2	4.5	3.3	4.7	3.3	5.0	3.3	5.3	3.1
	33	3.1	2.7	3.7	3.1	4.2	3.2	4.5	3.3	4.7	3.3	5.0	3.3	5.3	3.1
	35	3.1	2.7	3.7	3.1	4.2	3.2	4.5	3.3	4.7	3.3	5.0	3.3	5.3	3.1
	37	3.1	2.7	3.7	3.1	4.2	3.2	4.5	3.3	4.6	3.2	4.9	3.2	5.2	3.1
39	3.1	2.7	3.7	3.1	4.2	3.2	4.5	3.3	4.6	3.2	4.9	3.2	5.1	3.0	
42	3.1	2.7	3.7	3.1	4.2	3.2	4.4	3.3	4.5	3.2	4.8	3.1	5.0	2.9	
44	3.1	2.7	3.7	3.1	4.1	3.1	4.3	3.2	4.4	3.1	4.6	3.0	4.8	2.8	
46	3.1	2.7	3.7	3.1	4.0	3.0	4.2	3.1	4.3	3.0	4.5	2.9	4.7	2.7	
48	3.1	2.6	3.6	3.0	3.9	3.0	4.0	3.0	4.2	2.9	4.3	2.8	4.5	2.6	
056	10	3.9	3.3	4.6	3.8	5.3	4.0	5.6	4.2	5.8	4.2	6.3	4.3	6.7	4.1
	12	3.9	3.3	4.6	3.8	5.3	4.0	5.6	4.2	5.8	4.2	6.3	4.3	6.7	4.1
	14	3.9	3.3	4.6	3.8	5.3	4.0	5.6	4.2	5.8	4.2	6.2	4.2	6.7	4.1
	16	3.9	3.3	4.6	3.8	5.3	4.0	5.6	4.2	5.8	4.2	6.2	4.2	6.6	4.0
	18	3.9	3.3	4.6	3.8	5.3	4.0	5.6	4.2	5.8	4.2	6.2	4.2	6.6	4.0
	20	3.9	3.3	4.6	3.8	5.3	4.0	5.6	4.2	5.8	4.2	6.2	4.2	6.6	4.0
	21	3.9	3.3	4.6	3.8	5.3	4.0	5.6	4.2	5.8	4.2	6.2	4.2	6.6	4.0
	23	3.9	3.3	4.6	3.8	5.3	4.0	5.6	4.2	5.8	4.2	6.2	4.2	6.6	4.0
	25	3.9	3.3	4.6	3.8	5.3	4.0	5.6	4.2	5.8	4.2	6.2	4.2	6.6	4.0
	27	3.9	3.3	4.6	3.8	5.3	4.0	5.6	4.2	5.8	4.2	6.2	4.2	6.6	4.0
	29	3.9	3.3	4.6	3.8	5.3	4.0	5.6	4.2	5.8	4.2	6.2	4.2	6.6	4.0
	31	3.9	3.3	4.6	3.8	5.3	4.0	5.6	4.2	5.8	4.2	6.2	4.2	6.6	4.0
	33	3.9	3.3	4.6	3.8	5.3	4.0	5.6	4.2	5.8	4.2	6.2	4.2	6.6	4.0
	35	3.9	3.3	4.6	3.8	5.3	4.0	5.6	4.2	5.8	4.2	6.2	4.2	6.6	4.0
	37	3.9	3.3	4.6	3.8	5.3	4.0	5.6	4.2	5.8	4.2	6.1	4.1	6.5	3.9
39	3.9	3.3	4.6	3.8	5.3	4.0	5.6	4.2	5.8	4.2	6.1	4.1	6.4	3.8	
42	3.9	3.3	4.6	3.8	5.3	4.0	5.5	4.1	5.7	4.2	6.0	4.0	6.2	3.7	
44	3.9	3.3	4.6	3.8	5.1	3.9	5.3	4.0	5.6	4.0	5.8	3.9	6.0	3.6	
46	3.9	3.3	4.6	3.7	5.0	3.8	5.2	3.9	5.4	3.9	5.6	3.7	5.9	3.5	
48	3.9	3.2	4.5	3.7	5.0	3.7	5.0	3.8	5.3	3.8	5.4	3.6	5.7	3.3	

2 Capacity Table

Slim Duct

Cooling

TC : Total Capacity(kW), SHC : Sensible Heat Capacity(kW)

Capacity Index	Outdoor Air Temp. (°C,DB)	Indoor temperature													
		20(°C,DB)		23(°C,DB)		26(°C,DB)		27(°C,DB)		28(°C,DB)		30(°C,DB)		32(°C,DB)	
		14(°C,WB)		16(°C,WB)		18(°C,WB)		19(°C,WB)		20(°C,WB)		22(°C,WB)		24(°C,WB)	
		TC	SHC	TC	SHC	TC	SHC	TC	SHC	TC	SHC	TC	SHC	TC	SHC
071	10	4.9	4.3	5.8	5.0	6.7	5.2	7.1	5.4	7.4	5.6	8.0	5.7	8.5	5.4
	12	4.9	4.3	5.8	5.0	6.7	5.2	7.1	5.4	7.4	5.6	7.9	5.6	8.5	5.4
	14	4.9	4.3	5.8	5.0	6.7	5.2	7.1	5.4	7.4	5.6	7.9	5.6	8.5	5.4
	16	4.9	4.3	5.8	5.0	6.7	5.2	7.1	5.4	7.4	5.6	7.9	5.6	8.4	5.3
	18	4.9	4.3	5.8	5.0	6.7	5.2	7.1	5.4	7.4	5.6	7.9	5.6	8.4	5.3
	20	4.9	4.3	5.8	5.0	6.7	5.2	7.1	5.4	7.4	5.6	7.9	5.6	8.4	5.3
	21	4.9	4.3	5.8	5.0	6.7	5.2	7.1	5.4	7.4	5.6	7.9	5.6	8.4	5.3
	23	4.9	4.3	5.8	5.0	6.7	5.2	7.1	5.4	7.4	5.6	7.9	5.6	8.4	5.3
	25	4.9	4.3	5.8	5.0	6.7	5.2	7.1	5.4	7.4	5.6	7.9	5.6	8.4	5.3
	27	4.9	4.3	5.8	5.0	6.7	5.2	7.1	5.4	7.4	5.6	7.9	5.6	8.4	5.3
	29	4.9	4.3	5.8	5.0	6.7	5.2	7.1	5.4	7.4	5.6	7.9	5.6	8.4	5.3
	31	4.9	4.3	5.8	5.0	6.7	5.2	7.1	5.4	7.4	5.6	7.9	5.6	8.4	5.3
	33	4.9	4.3	5.8	5.0	6.7	5.2	7.1	5.4	7.4	5.6	7.9	5.6	8.4	5.3
	35	4.9	4.3	5.8	5.0	6.7	5.2	7.1	5.4	7.4	5.6	7.9	5.6	8.4	5.3
	37	4.9	4.3	5.8	5.0	6.7	5.2	7.1	5.4	7.3	5.5	7.8	5.5	8.2	5.2
	39	4.9	4.3	5.8	5.0	6.7	5.2	7.1	5.4	7.3	5.5	7.7	5.4	8.1	5.1
42	4.9	4.3	5.8	5.0	6.7	5.2	7.0	5.3	7.2	5.4	7.6	5.3	7.9	5.0	
44	4.9	4.3	5.8	5.0	6.5	5.0	6.8	5.2	7.0	5.3	7.3	5.1	7.6	4.8	
46	4.9	4.3	5.7	5.0	6.4	4.9	6.6	5.0	6.8	5.1	7.0	4.9	7.4	4.7	
48	4.8	4.2	5.7	4.9	6.3	4.9	6.4	4.9	6.7	5.0	6.8	4.8	7.2	4.5	
090	10	6.2	5.7	7.3	6.5	8.4	6.9	9.0	7.1	9.4	7.3	10.1	7.3	10.8	7.3
	12	6.2	5.7	7.3	6.5	8.4	6.9	9.0	7.1	9.4	7.3	10.1	7.3	10.8	7.3
	14	6.2	5.7	7.3	6.5	8.4	6.9	9.0	7.1	9.3	7.2	10.0	7.2	10.7	7.1
	16	6.2	5.7	7.3	6.5	8.4	6.9	9.0	7.1	9.3	7.2	10.0	7.2	10.7	7.1
	18	6.2	5.7	7.3	6.5	8.4	6.9	9.0	7.1	9.3	7.2	10.0	7.2	10.6	7.0
	20	6.2	5.7	7.3	6.5	8.4	6.9	9.0	7.1	9.3	7.2	10.0	7.2	10.6	7.0
	21	6.2	5.7	7.3	6.5	8.4	6.9	9.0	7.1	9.3	7.2	10.0	7.2	10.6	7.0
	23	6.2	5.7	7.3	6.5	8.4	6.9	9.0	7.1	9.3	7.2	10.0	7.2	10.6	7.0
	25	6.2	5.7	7.3	6.5	8.4	6.9	9.0	7.1	9.3	7.2	10.0	7.2	10.6	7.0
	27	6.2	5.7	7.3	6.5	8.4	6.9	9.0	7.1	9.3	7.2	10.0	7.2	10.6	7.0
	29	6.2	5.7	7.3	6.5	8.4	6.9	9.0	7.1	9.3	7.2	10.0	7.2	10.6	7.0
	31	6.2	5.7	7.3	6.5	8.4	6.9	9.0	7.1	9.3	7.2	10.0	7.2	10.6	7.0
	33	6.2	5.7	7.3	6.5	8.4	6.9	9.0	7.1	9.3	7.2	10.0	7.2	10.6	7.0
	35	6.2	5.7	7.3	6.5	8.4	6.9	9.0	7.1	9.3	7.2	10.0	7.2	10.6	7.0
	37	6.2	5.7	7.3	6.5	8.4	6.9	9.0	7.1	9.3	7.2	9.9	7.1	10.4	6.9
	39	6.2	5.7	7.3	6.5	8.4	6.9	9.0	7.1	9.2	7.1	9.7	7.0	10.2	6.8
42	6.2	5.7	7.3	6.5	8.3	6.8	8.9	7.0	9.1	7.0	9.5	6.9	9.9	6.6	
44	6.2	5.7	7.3	6.5	8.1	6.7	8.6	6.8	8.8	6.8	9.2	6.6	9.6	6.4	
46	6.2	5.7	7.2	6.4	8.0	6.6	8.3	6.6	8.6	6.6	8.9	6.4	9.3	6.2	
48	6.1	5.6	7.1	6.3	7.8	6.4	8.1	6.4	8.4	6.5	8.6	6.2	9.0	6.0	
112	10	7.7	6.8	9.1	7.7	10.5	8.2	11.2	8.6	11.6	8.8	12.5	8.9	13.4	8.6
	12	7.7	6.8	9.1	7.7	10.5	8.2	11.2	8.6	11.6	8.8	12.5	8.9	13.4	8.6
	14	7.7	6.8	9.1	7.7	10.5	8.2	11.2	8.6	11.6	8.8	12.5	8.9	13.4	8.6
	16	7.7	6.8	9.1	7.7	10.5	8.2	11.2	8.6	11.6	8.8	12.5	8.9	13.3	8.5
	18	7.7	6.8	9.1	7.7	10.5	8.2	11.2	8.6	11.6	8.8	12.5	8.9	13.3	8.5
	20	7.7	6.8	9.1	7.7	10.5	8.2	11.2	8.6	11.6	8.8	12.4	8.8	13.2	8.5
	21	7.7	6.8	9.1	7.7	10.5	8.2	11.2	8.6	11.6	8.8	12.4	8.8	13.2	8.5
	23	7.7	6.8	9.1	7.7	10.5	8.2	11.2	8.6	11.6	8.8	12.4	8.8	13.2	8.5
	25	7.7	6.8	9.1	7.7	10.5	8.2	11.2	8.6	11.6	8.8	12.4	8.8	13.2	8.5
	27	7.7	6.8	9.1	7.7	10.5	8.2	11.2	8.6	11.6	8.8	12.4	8.8	13.2	8.5
	29	7.7	6.8	9.1	7.7	10.5	8.2	11.2	8.6	11.6	8.8	12.4	8.8	13.2	8.5
	31	7.7	6.8	9.1	7.7	10.5	8.2	11.2	8.6	11.6	8.8	12.4	8.8	13.2	8.5
	33	7.7	6.8	9.1	7.7	10.5	8.2	11.2	8.6	11.6	8.8	12.4	8.8	13.2	8.5
	35	7.7	6.8	9.1	7.7	10.5	8.2	11.2	8.6	11.6	8.8	12.4	8.7	13.2	8.5
	37	7.7	6.8	9.1	7.7	10.5	8.2	11.2	8.6	11.6	8.8	12.4	8.9	13.2	8.5
	39	7.7	6.8	9.1	7.7	10.5	8.2	11.2	8.6	11.6	8.8	12.3	8.8	13.0	8.4
42	7.7	6.8	9.1	7.7	10.4	8.1	11.1	8.5	11.5	8.7	12.1	8.6	12.7	8.2	
44	7.7	6.8	9.1	7.7	10.1	7.9	10.7	8.2	11.1	8.4	11.6	8.3	12.2	7.9	
46	7.7	6.8	9.0	7.6	10.0	7.8	10.4	8.0	10.8	8.2	11.2	8.0	11.9	7.7	
48	7.6	6.7	8.9	7.5	9.8	7.7	10.1	7.7	10.6	8.0	10.9	7.8	11.5	7.4	

2 Capacity Table

Slim Duct

Cooling

TC : Total Capacity(kW), SHC : Sensible Heat Capacity(kW)

Capacity Index	Outdoor Air Temp. (°C,DB)	Indoor temperature													
		20(°C,DB)		23(°C,DB)		26(°C,DB)		27(°C,DB)		28(°C,DB)		30(°C,DB)		32(°C,DB)	
		14(°C,WB)		16(°C,WB)		18(°C,WB)		19(°C,WB)		20(°C,WB)		22(°C,WB)		24(°C,WB)	
		TC	SHC	TC	SHC	TC	SHC	TC	SHC	TC	SHC	TC	SHC	TC	SHC
128	10	8.8	7.8	10.4	8.9	12.0	9.5	12.8	9.9	13.3	9.9	14.3	10.0	15.4	9.9
	12	8.8	7.8	10.4	8.9	12.0	9.5	12.8	9.9	13.3	9.9	14.3	10.0	15.3	9.8
	14	8.8	7.8	10.4	8.9	12.0	9.5	12.8	9.9	13.3	9.9	14.3	10.0	15.3	9.8
	16	8.8	7.8	10.4	8.9	12.0	9.5	12.8	9.9	13.3	9.9	14.2	9.9	15.2	9.8
	18	8.8	7.8	10.4	8.9	12.0	9.5	12.8	9.9	13.3	9.9	14.2	9.9	15.1	9.7
	20	8.8	7.8	10.4	8.9	12.0	9.5	12.8	9.9	13.3	9.9	14.2	9.9	15.1	9.7
	21	8.8	7.8	10.4	8.9	12.0	9.5	12.8	9.9	13.3	9.9	14.2	9.9	15.1	9.7
	23	8.8	7.8	10.4	8.9	12.0	9.5	12.8	9.9	13.3	9.9	14.2	9.9	15.1	9.7
	25	8.8	7.8	10.4	8.9	12.0	9.5	12.8	9.9	13.3	9.9	14.2	9.9	15.1	9.7
	27	8.8	7.8	10.4	8.9	12.0	9.5	12.8	9.9	13.3	9.9	14.2	9.9	15.1	9.7
	29	8.8	7.8	10.4	8.9	12.0	9.5	12.8	9.9	13.3	9.9	14.2	9.9	15.1	9.7
	31	8.8	7.8	10.4	8.9	12.0	9.5	12.8	9.9	13.3	9.9	14.2	9.9	15.1	9.7
	33	8.8	7.8	10.4	8.9	12.0	9.5	12.8	9.9	13.3	9.9	14.2	9.9	15.1	9.7
	35	8.8	7.8	10.4	8.9	12.0	9.5	12.8	9.9	13.3	9.9	14.2	9.9	15.1	9.7
	37	8.8	7.8	10.4	8.9	12.0	9.5	12.8	9.9	13.2	9.9	14.0	9.8	14.9	9.6
	39	8.8	7.8	10.4	8.9	12.0	9.5	12.8	9.9	13.1	9.8	13.8	9.6	14.5	9.4
42	8.8	7.8	10.4	8.9	11.9	9.4	12.6	9.8	12.9	9.7	13.6	9.4	14.1	9.2	
44	8.8	7.8	10.4	8.9	11.6	9.2	12.2	9.5	12.6	9.4	13.0	9.1	13.6	8.8	
46	8.8	7.8	10.3	8.8	11.4	9.0	11.8	9.2	12.2	9.1	12.6	8.8	13.3	8.6	
48	8.7	7.7	10.2	8.7	11.2	8.9	11.5	8.9	12.0	8.9	12.2	8.5	12.8	8.3	
140	10	9.7	8.6	11.4	9.7	13.1	10.5	14.0	10.8	14.6	10.9	15.7	11.0	16.8	10.9
	12	9.7	8.6	11.4	9.7	13.1	10.5	14.0	10.8	14.5	10.8	15.6	10.9	16.7	10.8
	14	9.7	8.6	11.4	9.7	13.1	10.5	14.0	10.8	14.5	10.8	15.6	10.9	16.7	10.8
	16	9.7	8.6	11.4	9.7	13.1	10.5	14.0	10.8	14.5	10.8	15.6	10.9	16.6	10.7
	18	9.7	8.6	11.4	9.7	13.1	10.5	14.0	10.8	14.5	10.8	15.5	10.8	16.6	10.7
	20	9.7	8.6	11.4	9.7	13.1	10.5	14.0	10.8	14.5	10.8	15.5	10.8	16.5	10.6
	21	9.7	8.6	11.4	9.7	13.1	10.5	14.0	10.8	14.5	10.8	15.5	10.8	16.5	10.6
	23	9.7	8.6	11.4	9.7	13.1	10.5	14.0	10.8	14.5	10.8	15.5	10.8	16.5	10.6
	25	9.7	8.6	11.4	9.7	13.1	10.5	14.0	10.8	14.5	10.8	15.5	10.8	16.5	10.6
	27	9.7	8.6	11.4	9.7	13.1	10.5	14.0	10.8	14.5	10.8	15.5	10.8	16.5	10.6
	29	9.7	8.6	11.4	9.7	13.1	10.5	14.0	10.8	14.5	10.8	15.5	10.8	16.5	10.6
	31	9.7	8.6	11.4	9.7	13.1	10.5	14.0	10.8	14.5	10.8	15.5	10.8	16.5	10.6
	33	9.7	8.6	11.4	9.7	13.1	10.5	14.0	10.8	14.5	10.8	15.5	10.8	16.5	10.6
	35	9.7	8.6	11.4	9.7	13.1	10.5	14.0	10.8	14.5	10.8	15.5	10.8	16.5	10.6
	37	9.7	8.6	11.4	9.7	13.1	10.5	14.0	10.8	14.5	10.8	15.4	10.7	16.3	10.5
	39	9.7	8.6	11.4	9.7	13.1	10.5	14.0	10.8	14.4	10.7	15.1	10.5	15.9	10.3
42	9.7	8.6	11.4	9.7	13.0	10.4	13.8	10.7	14.2	10.6	14.8	10.3	15.5	10.0	
44	9.7	8.6	11.4	9.7	12.7	10.1	13.4	10.3	13.8	10.3	14.2	9.9	15.0	9.7	
46	9.7	8.6	11.3	9.6	12.4	10.0	12.9	10.0	13.4	10.0	13.8	9.6	14.6	9.4	
48	9.6	8.5	11.1	9.5	12.2	9.8	12.6	9.7	13.1	9.8	13.4	9.3	14.1	9.1	

2 Capacity Table

Slim Duct

Heating

TC : Total Capacity(kW)

Capacity Index	Outdoor Air Temp. (°C)		Indoor temperature (°C,DB)				
			16(°C,DB)	18(°C,DB)	20(°C,DB)	22(°C,DB)	24(°C,DB)
	DB	WB	TC kW	TC kW	TC kW	TC kW	TC kW
017	-19.8	-20.0	1.1	1.1	1.1	1.1	1.1
	-18.8	-19.0	1.1	1.1	1.1	1.1	1.1
	-16.7	-17.0	1.2	1.2	1.2	1.2	1.2
	-14.7	-15.0	1.3	1.2	1.2	1.2	1.2
	-12.6	-13.0	1.4	1.4	1.4	1.4	1.3
	-10.5	-11.0	1.5	1.5	1.4	1.4	1.4
	-9.5	-10.0	1.6	1.5	1.5	1.4	1.4
	-8.5	-9.1	1.7	1.6	1.6	1.5	1.5
	-7.0	-7.6	1.8	1.7	1.7	1.5	1.5
	-5.0	-5.6	1.8	1.8	1.8	1.7	1.7
	-3.0	-3.7	1.9	1.9	1.8	1.8	1.7
	0.0	-0.7	2.0	1.9	1.9	1.8	1.7
	3.0	2.2	2.0	2.0	1.9	1.8	1.7
	5.0	4.1	2.1	2.0	1.9	1.8	1.7
	7.0	6.0	2.1	2.0	1.9	1.8	1.7
9.0	7.9	2.3	2.0	1.9	1.8	1.7	
022	-19.8	-20.0	1.5	1.5	1.5	1.5	1.5
	-18.8	-19.0	1.5	1.5	1.5	1.5	1.5
	-16.7	-17.0	1.6	1.6	1.6	1.6	1.6
	-14.7	-15.0	1.7	1.6	1.6	1.6	1.6
	-12.6	-13.0	1.8	1.8	1.8	1.8	1.7
	-10.5	-11.0	2.0	2.0	1.9	1.9	1.9
	-9.5	-10.0	2.1	2.0	2.0	1.9	1.9
	-8.5	-9.1	2.2	2.1	2.1	2.0	2.0
	-7.0	-7.6	2.3	2.2	2.2	2.0	2.0
	-5.0	-5.6	2.4	2.3	2.3	2.2	2.2
	-3.0	-3.7	2.5	2.5	2.4	2.3	2.2
	0.0	-0.7	2.6	2.5	2.5	2.3	2.2
	3.0	2.2	2.7	2.6	2.5	2.3	2.2
	5.0	4.1	2.8	2.7	2.5	2.3	2.2
	7.0	6.0	2.8	2.7	2.5	2.3	2.2
9.0	7.9	3.0	2.7	2.5	2.3	2.2	
11.0	9.8	3.0	2.7	2.5	2.3	2.2	
13.0	11.8	3.0	2.7	2.5	2.3	2.2	
15.0	13.7	3.0	2.7	2.5	2.3	2.2	
028	-19.8	-20.0	1.9	1.9	1.9	1.9	1.9
	-18.8	-19.0	1.9	1.9	1.9	1.9	1.9
	-16.7	-17.0	2.0	2.0	2.0	2.0	1.9
	-14.7	-15.0	2.1	2.1	2.0	2.0	1.9
	-12.6	-13.0	2.2	2.2	2.2	2.1	2.1
	-10.5	-11.0	2.3	2.3	2.3	2.3	2.2
	-9.5	-10.0	2.3	2.3	2.3	2.3	2.2
	-8.5	-9.1	2.4	2.4	2.4	2.4	2.3
	-7.0	-7.6	2.5	2.4	2.4	2.4	2.3
	-5.0	-5.6	2.6	2.6	2.5	2.5	2.4
	-3.0	-3.7	2.8	2.7	2.7	2.6	2.5
	0.0	-0.7	2.9	2.8	2.8	2.7	2.6
	3.0	2.2	3.0	3.0	2.9	2.8	2.7
	5.0	4.1	3.2	3.1	3.1	2.9	2.7
	7.0	6.0	3.3	3.2	3.2	3.0	2.7
9.0	7.9	3.4	3.3	3.2	3.0	2.7	
11.0	9.8	3.5	3.3	3.2	3.0	2.7	
13.0	11.8	3.6	3.4	3.2	3.0	2.7	
15.0	13.7	3.7	3.4	3.2	3.0	2.7	

2 Capacity Table

Slim Duct

Heating

TC : Total Capacity(kW)

Capacity Index	Outdoor Air Temp. (°C)		Indoor temperature (°C,DB)				
			16(°C,DB)	18(°C,DB)	20(°C,DB)	22(°C,DB)	24(°C,DB)
	DB	WB	TC kW	TC kW	TC kW	TC kW	TC kW
036	-19.8	-20.0	2.4	2.4	2.3	2.3	2.3
	-18.8	-19.0	2.5	2.4	2.3	2.3	2.3
	-16.7	-17.0	2.6	2.5	2.4	2.4	2.3
	-14.7	-15.0	2.7	2.6	2.5	2.5	2.4
	-12.6	-13.0	2.8	2.7	2.7	2.6	2.6
	-10.5	-11.0	2.9	2.9	2.9	2.8	2.8
	-9.5	-10.0	2.9	2.9	2.9	2.8	2.8
	-8.5	-9.1	3.0	3.0	3.0	2.9	2.9
	-7.0	-7.6	3.1	3.1	3.0	3.0	2.9
	-5.0	-5.6	3.3	3.2	3.2	3.1	3.0
	-3.0	-3.7	3.4	3.4	3.3	3.2	3.1
	0.0	-0.7	3.6	3.6	3.5	3.4	3.2
	3.0	2.2	3.8	3.7	3.7	3.5	3.4
	5.0	4.1	3.9	3.9	3.8	3.6	3.4
	7.0	6.0	4.1	4.1	4.0	3.7	3.4
9.0	7.9	4.2	4.1	4.0	3.7	3.4	
11.0	9.8	4.4	4.2	4.0	3.7	3.4	
13.0	11.8	4.5	4.2	4.0	3.7	3.4	
15.0	13.7	4.6	4.3	4.0	3.7	3.4	
045	-19.8	-20.0	3.1	3.1	2.9	2.9	2.9
	-18.8	-19.0	3.1	3.1	3.0	2.9	2.9
	-16.7	-17.0	3.2	3.2	3.1	3.0	3.0
	-14.7	-15.0	3.3	3.3	3.2	3.1	3.0
	-12.6	-13.0	3.5	3.4	3.4	3.3	3.2
	-10.5	-11.0	3.7	3.6	3.6	3.5	3.4
	-9.5	-10.0	3.7	3.6	3.6	3.5	3.5
	-8.5	-9.1	3.8	3.7	3.7	3.6	3.6
	-7.0	-7.6	3.9	3.8	3.8	3.7	3.6
	-5.0	-5.6	4.1	4.0	4.0	3.9	3.7
	-3.0	-3.7	4.3	4.2	4.2	4.0	3.9
	0.0	-0.7	4.5	4.4	4.4	4.2	4.0
	3.0	2.2	4.7	4.7	4.6	4.4	4.2
	5.0	4.1	4.9	4.9	4.8	4.5	4.2
	7.0	6.0	5.1	5.1	5.0	4.6	4.2
9.0	7.9	5.3	5.2	5.0	4.6	4.2	
11.0	9.8	5.5	5.2	5.0	4.6	4.2	
13.0	11.8	5.6	5.3	5.0	4.6	4.2	
15.0	13.7	5.8	5.4	5.0	4.6	4.2	
056	-19.8	-20.0	3.9	3.8	3.8	3.7	3.7
	-18.8	-19.0	3.9	3.9	3.8	3.7	3.7
	-16.7	-17.0	4.0	4.0	3.9	3.8	3.8
	-14.7	-15.0	4.2	4.1	4.0	3.9	3.8
	-12.6	-13.0	4.4	4.3	4.2	4.1	4.0
	-10.5	-11.0	4.6	4.5	4.4	4.4	4.3
	-9.5	-10.0	4.7	4.6	4.6	4.5	4.4
	-8.5	-9.1	4.8	4.7	4.7	4.6	4.5
	-7.0	-7.6	4.9	4.8	4.8	4.7	4.5
	-5.0	-5.6	5.2	5.1	5.0	4.9	4.7
	-3.0	-3.7	5.4	5.3	5.3	5.1	4.9
	0.0	-0.7	5.7	5.6	5.5	5.3	5.0
	3.0	2.2	5.9	5.9	5.8	5.6	5.3
	5.0	4.1	6.2	6.1	6.0	5.7	5.3
	7.0	6.0	6.5	6.4	6.3	5.8	5.3
9.0	7.9	6.7	6.5	6.3	5.8	5.3	
11.0	9.8	6.9	6.6	6.3	5.8	5.3	
13.0	11.8	7.1	6.7	6.3	5.8	5.3	
15.0	13.7	7.3	6.8	6.3	5.8	5.3	

2 Capacity Table

Slim Duct

Heating

TC : Total Capacity(kW)

Capacity Index	Outdoor Air Temp. (°C)		Indoor temperature (°C,DB)				
			16(°C,DB)	18(°C,DB)	20(°C,DB)	22(°C,DB)	24(°C,DB)
	DB	WB	TC kW	TC kW	TC kW	TC kW	TC kW
071	-19.8	-20.0	4.9	4.9	4.8	4.7	4.7
	-18.8	-19.0	5.0	4.9	4.8	4.7	4.7
	-16.7	-17.0	5.1	5.0	4.9	4.8	4.8
	-14.7	-15.0	5.3	5.2	5.1	4.9	4.8
	-12.6	-13.0	5.5	5.4	5.3	5.2	5.1
	-10.5	-11.0	5.8	5.7	5.6	5.5	5.5
	-9.5	-10.0	6.0	5.9	5.8	5.7	5.6
	-8.5	-9.1	6.1	6.0	5.9	5.8	5.7
	-7.0	-7.6	6.2	6.1	6.0	5.9	5.8
	-5.0	-5.6	6.5	6.5	6.4	6.2	6.0
	-3.0	-3.7	6.9	6.8	6.7	6.4	6.2
	0.0	-0.7	7.2	7.1	7.0	6.7	6.4
	3.0	2.2	7.6	7.5	7.3	7.1	6.8
	5.0	4.1	7.9	7.8	7.7	7.2	6.8
	7.0	6.0	8.2	8.1	8.0	7.4	6.8
9.0	7.9	8.5	8.2	8.0	7.4	6.8	
11.0	9.8	8.7	8.4	8.0	7.4	6.8	
13.0	11.8	9.0	8.5	8.0	7.4	6.8	
15.0	13.7	9.2	8.6	8.0	7.4	6.8	
090	-19.8	-20.0	6.0	6.0	5.9	5.8	5.8
	-18.8	-19.0	6.1	6.1	6.0	5.9	5.8
	-16.7	-17.0	6.4	6.3	6.1	6.0	5.9
	-14.7	-15.0	6.7	6.5	6.3	6.2	6.1
	-12.6	-13.0	6.9	6.8	6.6	6.5	6.4
	-10.5	-11.0	7.2	7.1	7.0	6.9	6.9
	-9.5	-10.0	7.4	7.3	7.2	7.1	7.0
	-8.5	-9.1	7.6	7.5	7.4	7.2	7.1
	-7.0	-7.6	7.8	7.7	7.6	7.4	7.2
	-5.0	-5.6	8.2	8.1	8.0	7.7	7.5
	-3.0	-3.7	8.6	8.5	8.4	8.1	7.7
	0.0	-0.7	9.0	8.9	8.8	8.4	8.0
	3.0	2.2	9.4	9.3	9.2	8.8	8.4
	5.0	4.1	9.9	9.7	9.6	9.0	8.4
	7.0	6.0	10.3	10.1	10.0	9.2	8.4
9.0	7.9	10.6	10.3	10.0	9.2	8.4	
11.0	9.8	10.9	10.5	10.0	9.2	8.4	
13.0	11.8	11.2	10.6	10.0	9.2	8.4	
15.0	13.7	11.6	10.8	10.0	9.2	8.4	
112	-19.8	-20.0	7.4	7.4	7.3	7.3	7.3
	-18.8	-19.0	7.6	7.6	7.4	7.4	7.3
	-16.7	-17.0	8.1	7.8	7.6	7.5	7.4
	-14.7	-15.0	8.4	8.2	8.0	7.8	7.6
	-12.6	-13.0	8.7	8.5	8.3	8.1	8.0
	-10.5	-11.0	9.1	8.9	8.8	8.7	8.6
	-9.5	-10.0	9.3	9.1	9.0	8.9	8.8
	-8.5	-9.1	9.5	9.3	9.2	9.0	8.9
	-7.0	-7.6	9.7	9.6	9.4	9.2	9.0
	-5.0	-5.6	10.2	10.1	9.9	9.6	9.3
	-3.0	-3.7	10.7	10.6	10.5	10.1	9.7
	0.0	-0.7	11.3	11.1	11.1	10.5	10.0
	3.0	2.2	11.8	11.6	11.5	11.0	10.6
	5.0	4.1	12.3	12.2	12.0	11.3	10.6
	7.0	6.0	12.9	12.7	12.5	11.5	10.6
9.0	7.9	13.3	12.9	12.5	11.5	10.6	
11.0	9.8	13.7	13.1	12.5	11.5	10.6	
13.0	11.8	14.0	13.3	12.5	11.5	10.6	
15.0	13.7	14.4	13.5	12.5	11.5	10.6	

2 Capacity Table

Slim Duct

Heating

TC : Total Capacity(kW)

Capacity Index	Outdoor Air Temp. (°C)		Indoor temperature (°C,DB)				
			16(°C,DB)	18(°C,DB)	20(°C,DB)	22(°C,DB)	24(°C,DB)
	DB	WB	TC kW	TC kW	TC kW	TC kW	TC kW
128	-19.8	-20.0	8.1	8.1	8.0	8.0	8.0
	-18.8	-19.0	8.3	8.3	8.2	8.1	8.0
	-16.7	-17.0	8.8	8.6	8.4	8.3	8.1
	-14.7	-15.0	9.3	9.1	8.8	8.6	8.3
	-12.6	-13.0	9.6	9.4	9.2	9.0	8.8
	-10.5	-11.0	10.0	9.9	9.8	9.6	9.4
	-9.5	-10.0	10.2	10.1	10.0	9.8	9.7
	-8.5	-9.1	10.4	10.3	10.2	10.0	9.8
	-7.0	-7.6	10.7	10.6	10.4	10.2	10.0
	-5.0	-5.6	11.3	11.1	11.0	10.7	10.3
	-3.0	-3.7	11.9	11.7	11.5	11.1	10.7
	0.0	-0.7	12.4	12.3	12.1	11.6	11.0
	3.0	2.2	13.0	12.9	12.7	12.2	11.7
	5.0	4.1	13.6	13.4	13.2	12.4	11.7
	7.0	6.0	14.2	14.0	13.8	12.7	11.7
9.0	7.9	14.6	14.2	13.8	12.7	11.7	
11.0	9.8	15.1	14.4	13.8	12.7	11.7	
13.0	11.8	15.5	14.7	13.8	12.7	11.7	
15.0	13.7	15.9	14.9	13.8	12.7	11.7	
140	-19.8	-20.0	9.5	9.5	9.4	9.4	9.3
	-18.8	-19.0	9.7	9.7	9.5	9.5	9.3
	-16.7	-17.0	10.2	10.0	9.7	9.6	9.4
	-14.7	-15.0	10.8	10.5	10.2	9.9	9.6
	-12.6	-13.0	11.1	10.9	10.7	10.4	10.1
	-10.5	-11.0	11.6	11.5	11.3	11.1	10.9
	-9.5	-10.0	11.8	11.7	11.5	11.4	11.2
	-8.5	-9.1	12.1	11.9	11.8	11.6	11.3
	-7.0	-7.6	12.4	12.2	12.1	11.8	11.5
	-5.0	-5.6	13.1	12.9	12.7	12.3	12.0
	-3.0	-3.7	13.8	13.6	13.4	12.9	12.4
	0.0	-0.7	14.4	14.2	14.0	13.4	12.8
	3.0	2.2	15.1	14.9	14.7	14.1	13.5
	5.0	4.1	15.8	15.6	15.3	14.4	13.5
	7.0	6.0	16.5	16.2	16.0	14.8	13.5
9.0	7.9	17.0	16.5	16.0	14.8	13.5	
11.0	9.8	17.5	16.7	16.0	14.8	13.5	
13.0	11.8	18.0	17.0	16.0	14.8	13.5	
15.0	13.7	18.5	17.2	16.0	14.8	13.5	

3 Dimensional Drawing

Slim Duct

AM017/022/028/036FNLDEH/EU

[Unit : mm]

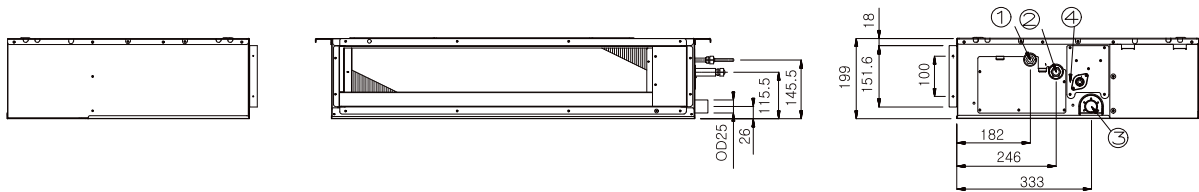
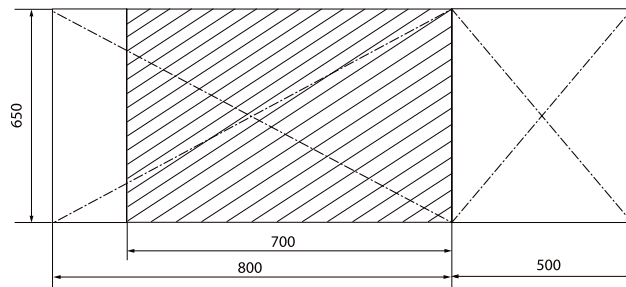
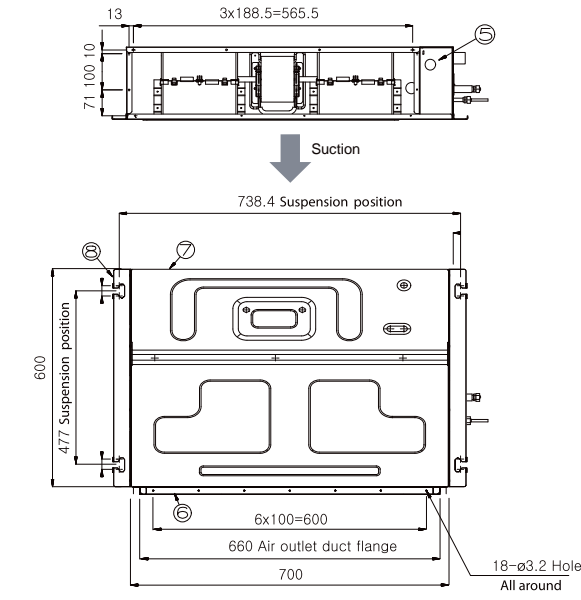

No.	Name	Description
1	Liquid pipe connection	ø6.35
2	Gas pipe connection	ø12.70
3	Drain pipe connection without drain pump	VP25 (OD ø32, ID ø25)
4	Drain pipe connection with drain pump	VP25 (OD ø32, ID ø25)
5	Power supply/Communication connection	-
6	Air discharge grille flange	-
7	Return air side	-
8	Hook	ø9.52 or M10

3 Dimensional Drawing

Slim Duct (Home)

AM017/022/028/036KNLDEH/EU

[Unit : mm]

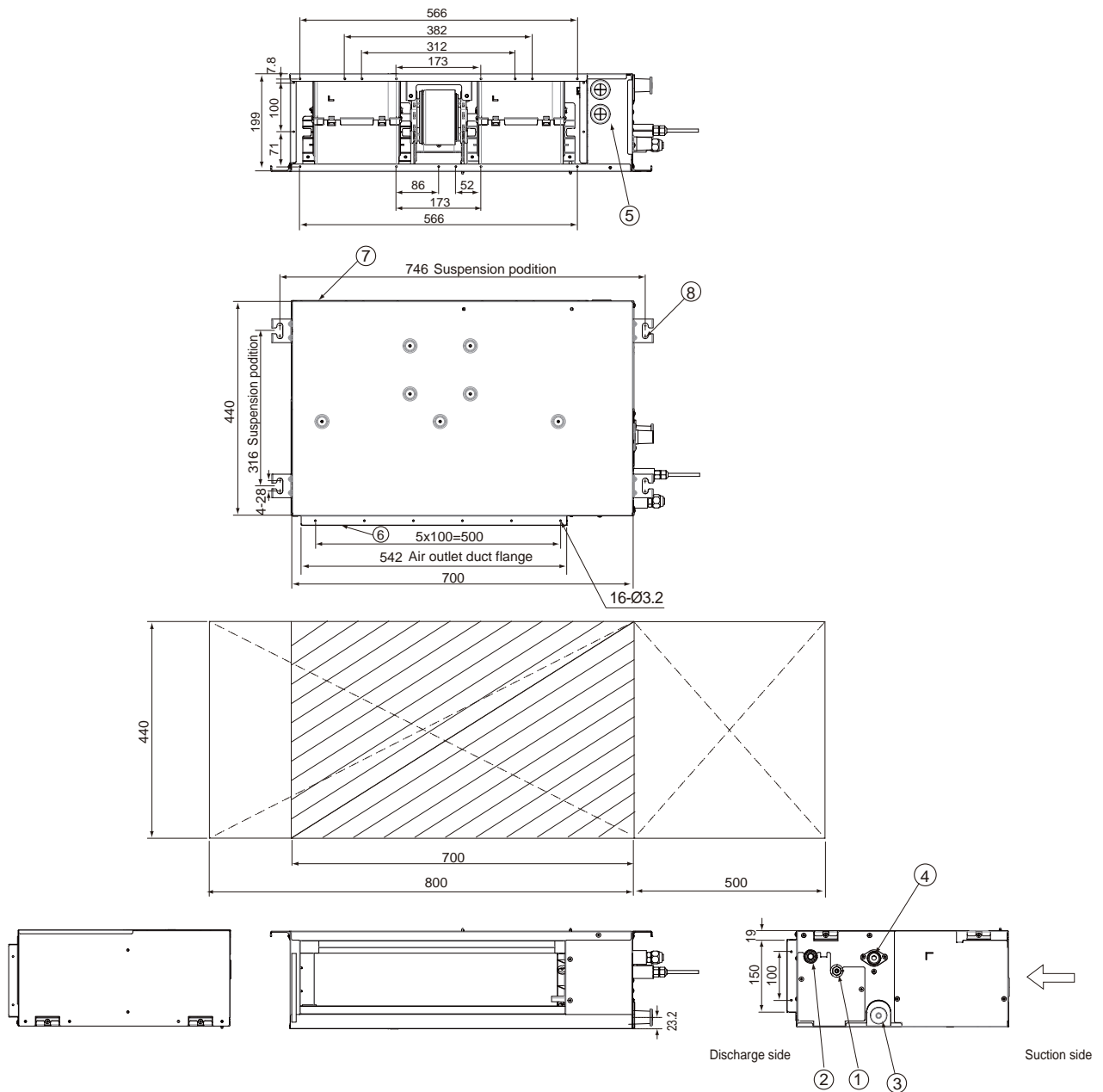

No.	Name	Description
1	Liquid pipe connection	ø6.35
2	Gas pipe connection	ø12.70
3	Drain pipe connection without drain pump	VP25 (OD ø32, ID ø25)
4	Drain pipe connection with drain pump	VP25 (OD ø32, ID ø25)
5	Power supply/Communication connection	-
6	Air discharge grille flange	-
7	Return air side	-
8	Hook	ø9.52 or M10

3 Dimensional Drawing

Slim Duct

AM045/056*NLDEH/EU

[Unit : mm]

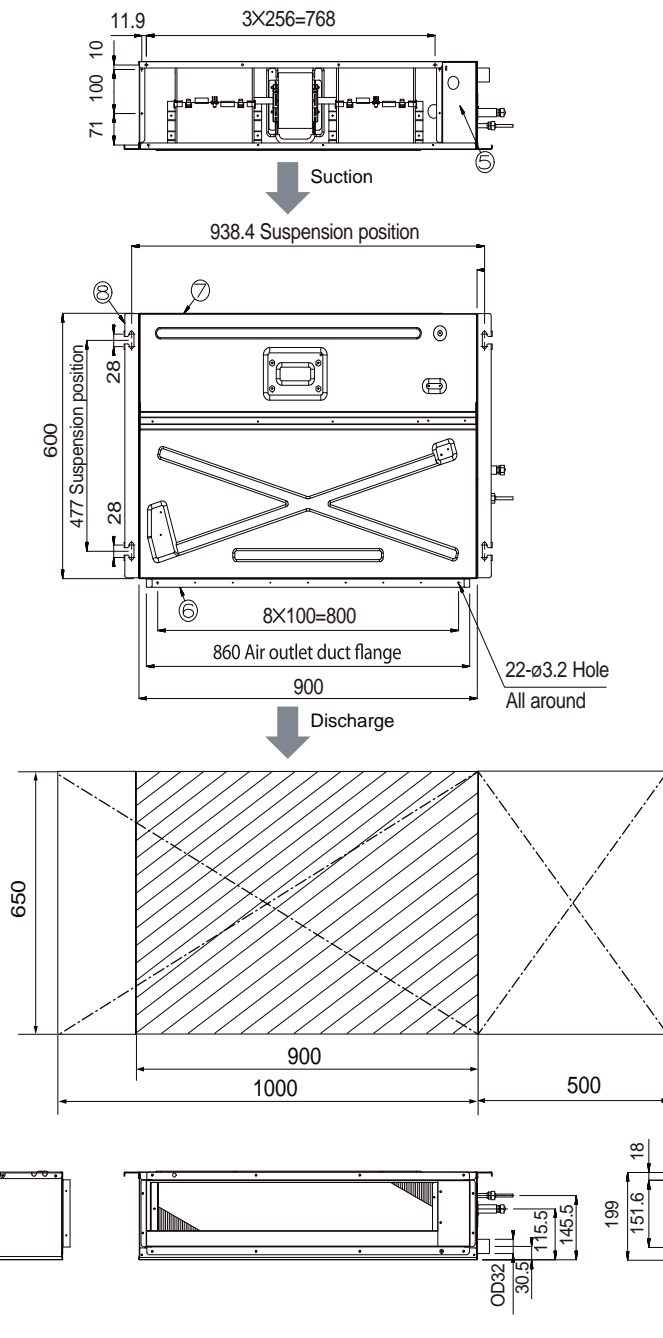

No.	Name	Description	
		4.5kW	5.6kW
①	Liquid pipe connection	Ø6.35 Flare	
②	Gas pipe connection	Ø12.70 Flare	
③	Drain pipe connection without drain pump	VP25 (OD 32, ID 25)	
④	Drain pipe connection with drain pump	VP25 (OD 32, ID 25)	
⑤	Power supply/Communication connection	-	
⑥	Air discharge grille flange	-	
⑦	Return air side	-	
⑧	Hook	-	

3 Dimensional Drawing

Slim Duct

AM071*NLDEH/EU

[Unit : mm]

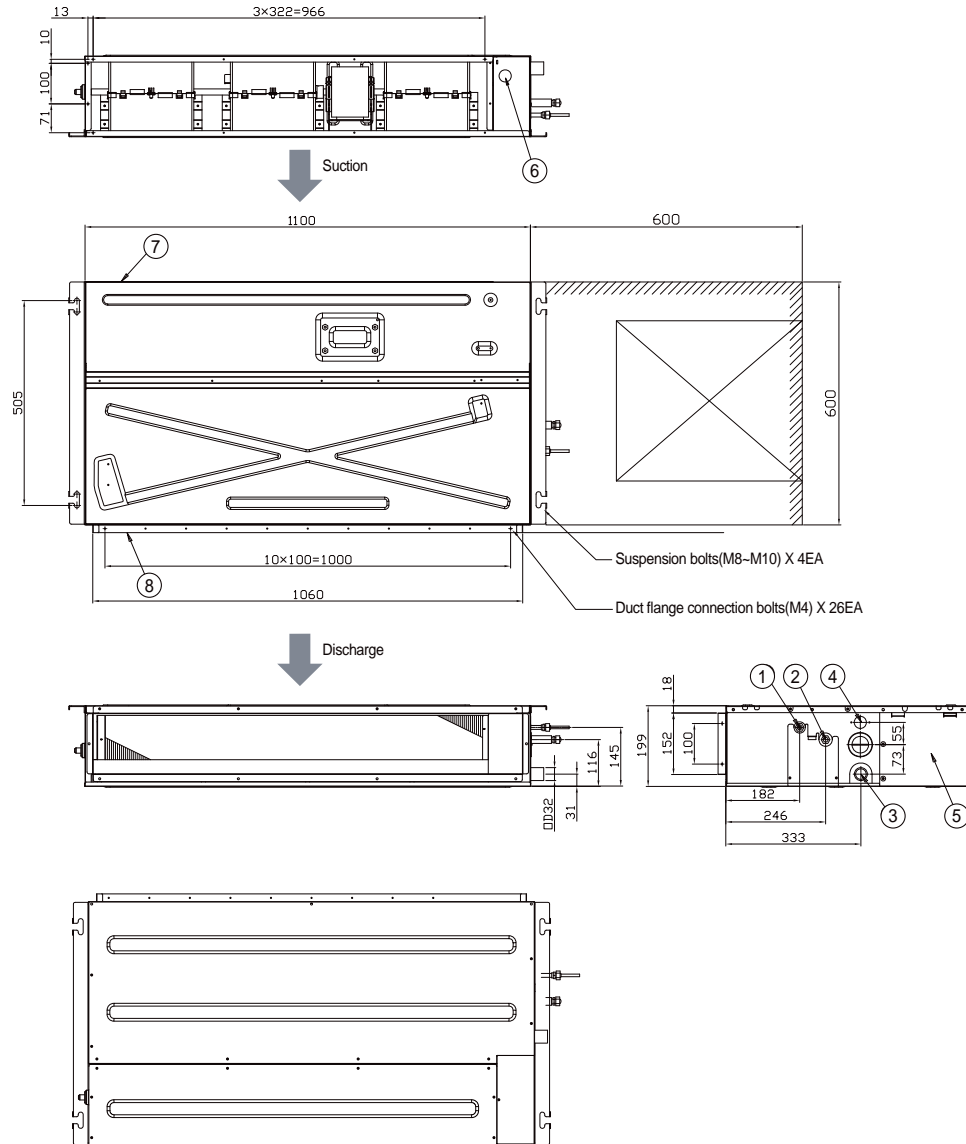

No.	Name	Description
		7.1kW
①	Liquid pipe connection	Ø9.52 Flare
②	Gas pipe connection	Ø15.88 Flare
③	Drain pipe connection without drain pump	VP25 (OD 32, ID 25)
④	Drain pipe connection with drain pump	VP25 (OD 32, ID 25)
⑤	Control unit	
⑥	Conduit for power supply & communication wiring	
⑦	Return air side	
⑧	Air outlet duct flange	

3 Dimensional Drawing

Slim Duct

AM090/112/128/140*NLDEH/EU

[Unit : mm]

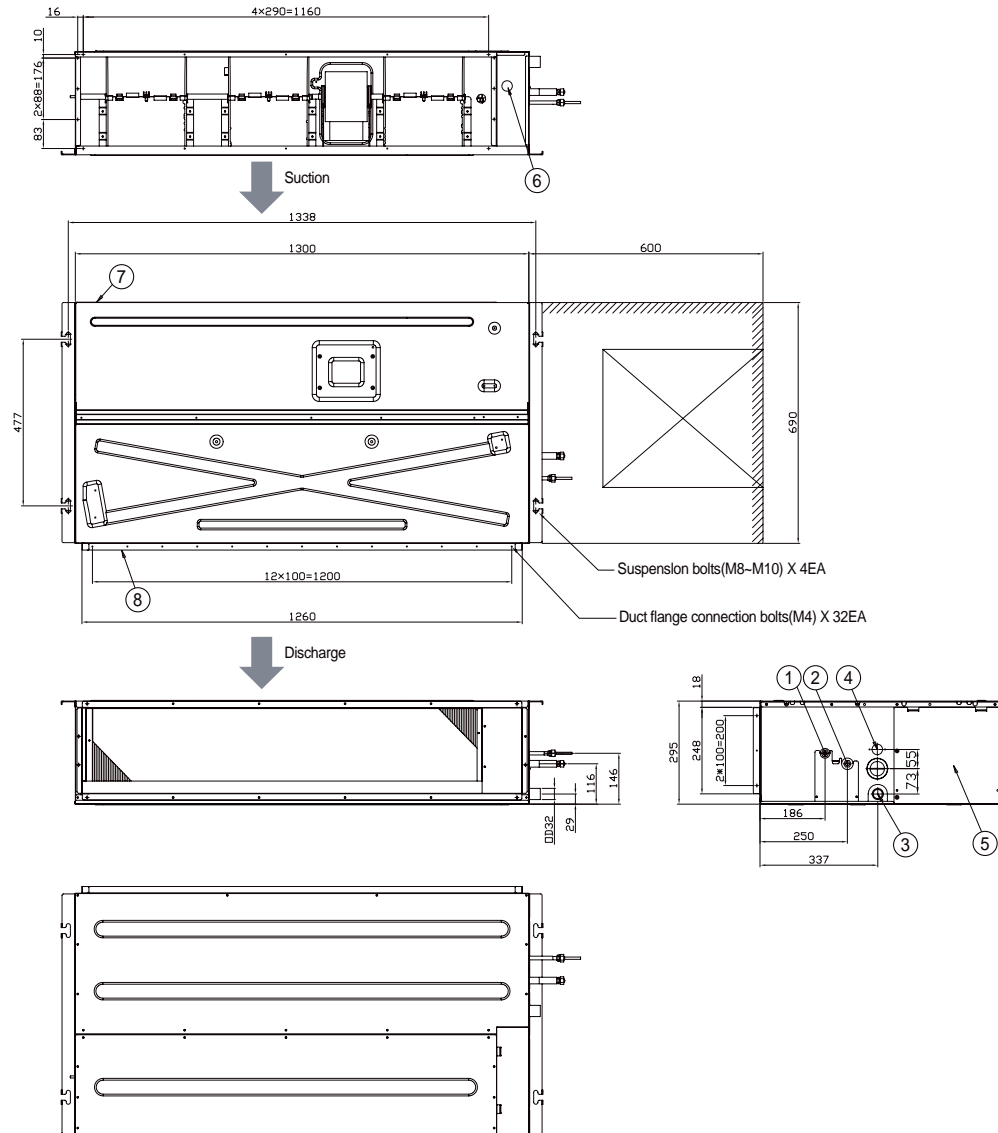

No.	Name	Description			
		9.0kW	11.2kW	12.8kW	14.0kW
①	Liquid pipe connection	Ø9.52 Flare			
②	Gas pipe connection	Ø15.88 Flare			
③	Drain pipe connection without drain pump	VP25 (OD 32, ID 25)			
④	Drain pipe connection with drain pump	VP25 (OD 32, ID 25)			
⑤	Control unit	-			
⑥	Conduit for power supply & communication wiring	-			
⑦	Return air side	-			
⑧	Air outlet duct flange	-			

4 Electrical Wiring Diagram

Slim Duct

AM017/022/028/036/045/056/071FNLDEH/EU, AM045/056/071KNLDEH/EU

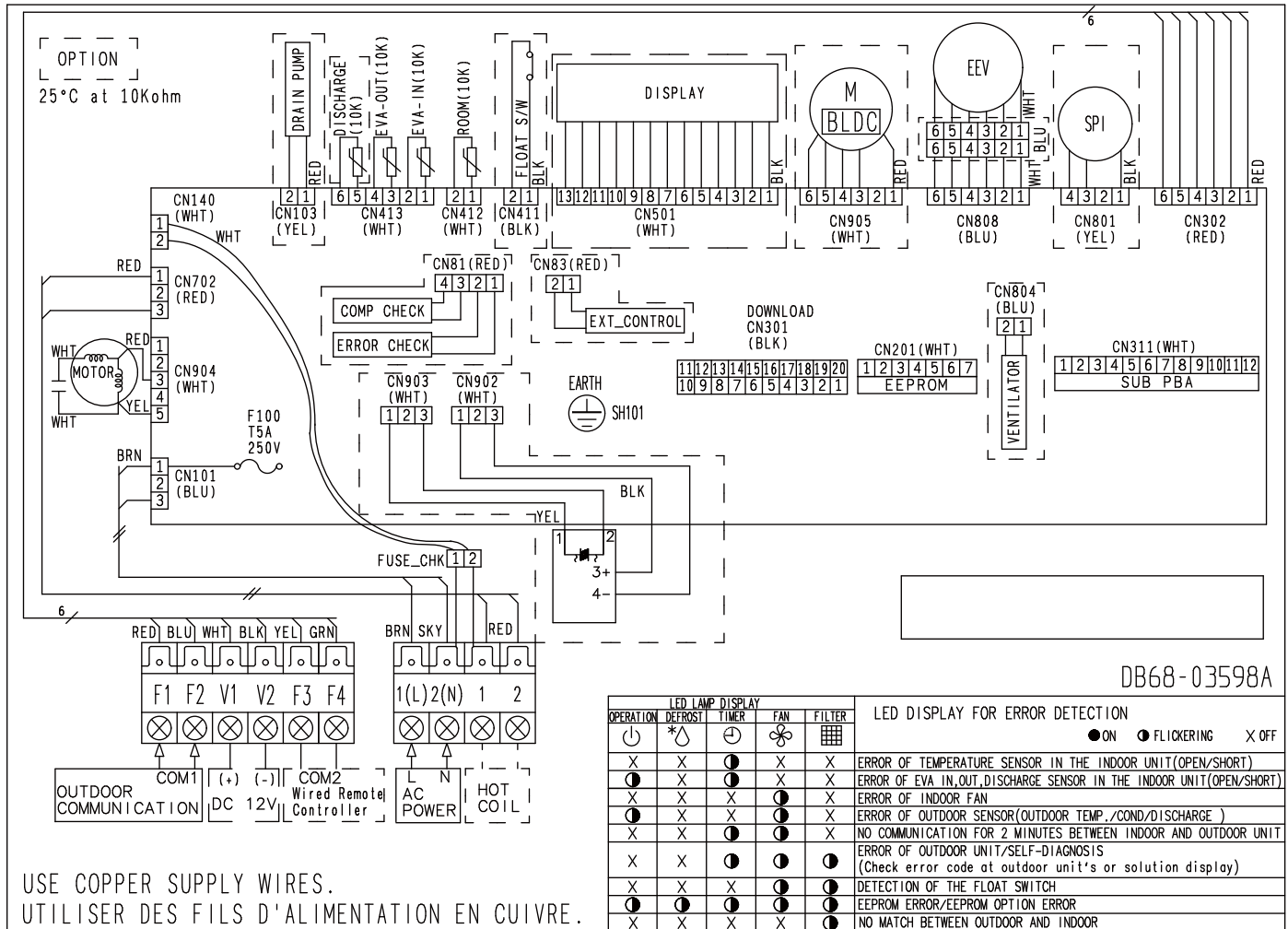

ROOM(10K)	Thermistor ROOM(10K)	EEV	electronic expansion valve	EVA-IN(10K)	Thermistor EVA IN(10K)
DISCHARGE(10K)	Thermistor DISCHARGE(10K)	SPI	S-Plasma ion	EVA-OUT(10K)	Thermistor EVA OUT(10K)

NOTE

1. This wiring diagram applies only to the indoor unit.
2. Symbols show as follow;
BLK : black, RED : red, BLU : blue, WHT:white, YEL : yellow, BRN : brown, SKY : sky-blue, GRN : green
3. For connection wiring indoor-outdoor transmission F1-F2, indoor-wired remotecontroller transmission F3-F4.
4. : Protective earth(screw), : Connector, n : The wire quantity

4 Electrical Wiring Diagram

Slim Duct / Slim Duct Home

AM090/112/128/140FNLDEH/EU, AM017/022/028/036/090/112/128/140KNLDEH/EU

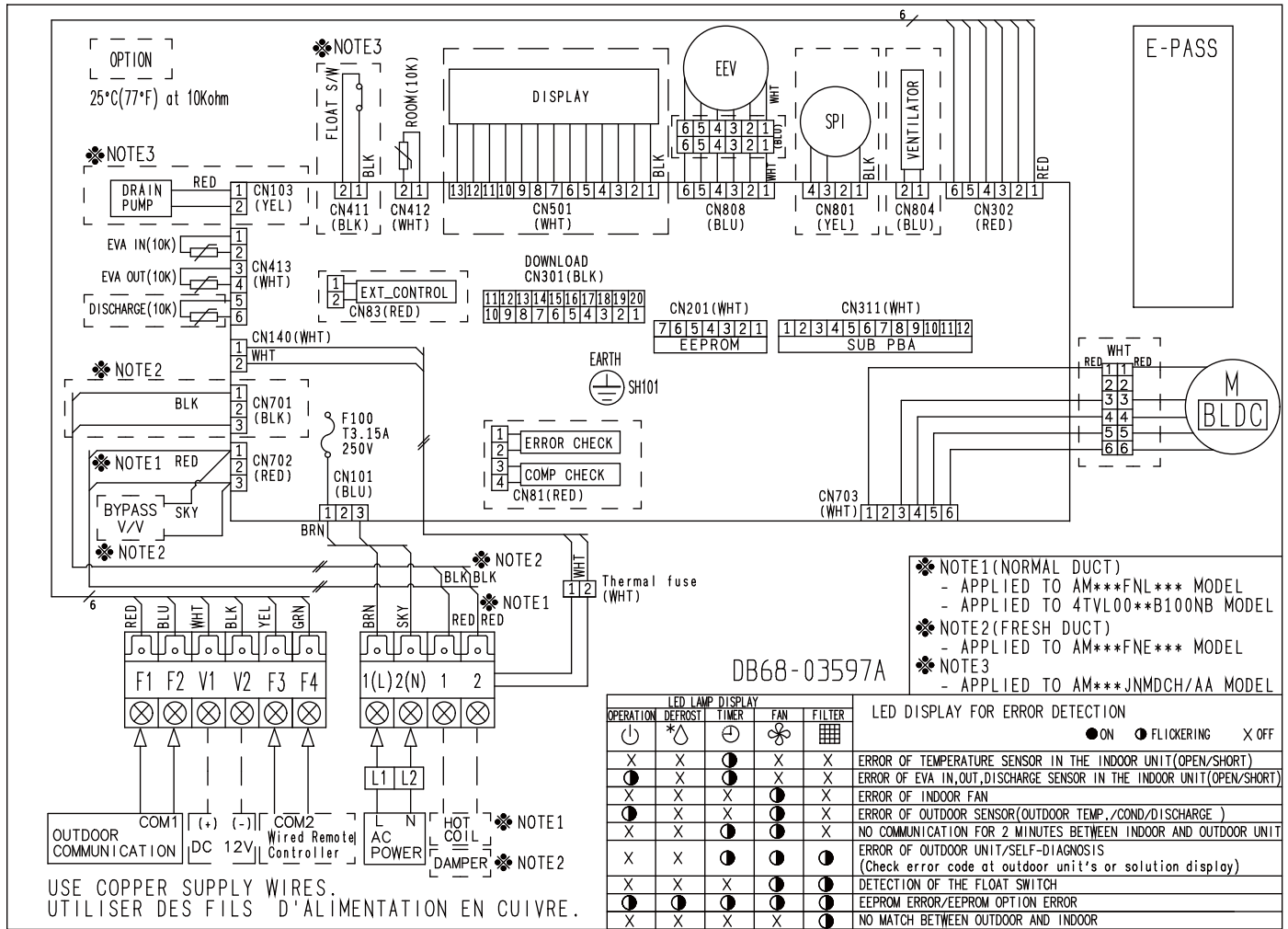

M[BLDC]	Motor (BLDC)	EEV	electronic expansion valve	EVA-IN(10K)	Thermistor EVA IN(10K)
DISCHARGE(10K)	Thermistor DISCHARGE(10K)	SPI	S-Plasma ion	EVA-OUT(10K)	Thermistor EVA OUT(10K)

NOTE

- This wiring diagram applies only to the indoor unit.
- Symbols show as follow;
BLK : black, RED : red, BLU : blue, WHT:white, YEL : yellow, BRN : brown, SKY : sky-blue, GRN : green
- For connection wiring indoor-outdoor transmission F1-F2, indoor-wired remotecontroller transmission F3-F4.
- ⊕: Protective earth(screw), □□□□: Connector, n/___: The wire quantity

5 Sound Pressure Level

Slim Duct

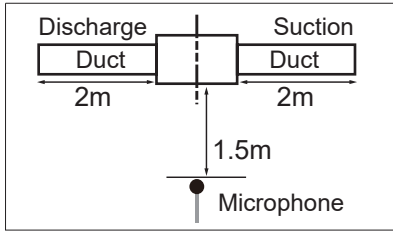

Unit: dB(A)

Model	High	Low
AM017FNLDEH/EU	23	20
AM022FNLDEH/EU	26	21
AM028FNLDEH/EU	28	23
AM036FNLDEH/EU	32	27

Note

Specifications may be subject to change without prior notice.
 Sound pressure level is obtained in an anechoic room.
 Sound pressure level is a relative value, depending on the distance and acoustic environment.
 Sound pressure level may differ depending on operation condition.
 dBA = A-weighted sound pressure level
 Reference acoustic pressure 0 dB= 20 uPa

NR curve

1) AM017FNLDEH/EU

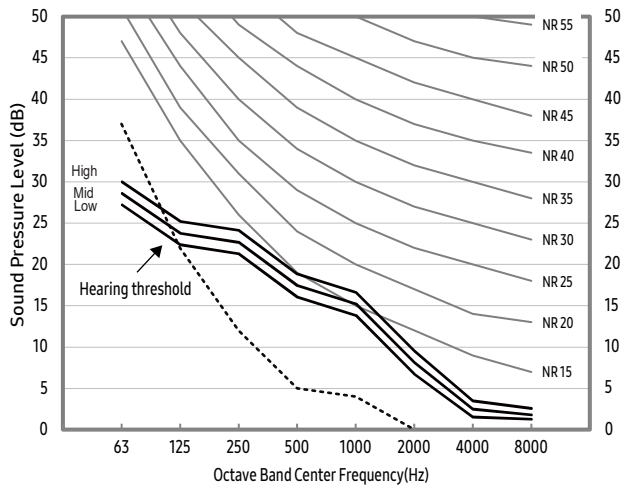

2) AM022FNLDEH/EU

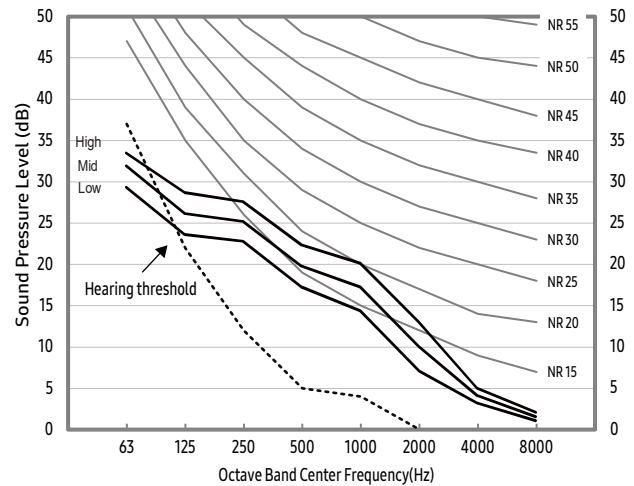

3) AM028FNLDEH/EU

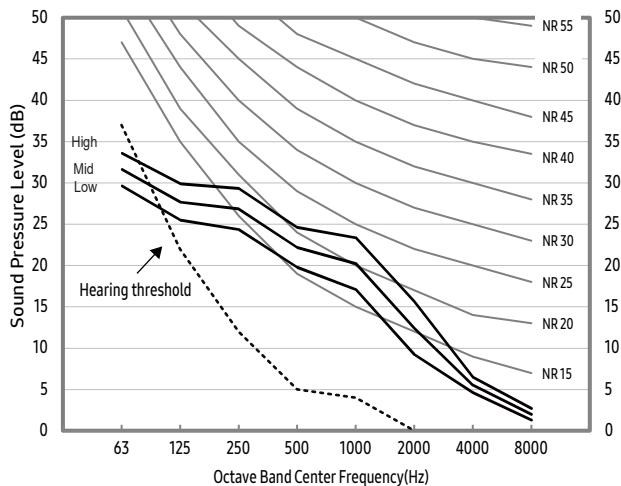

4) AM036FNLDEH/EU

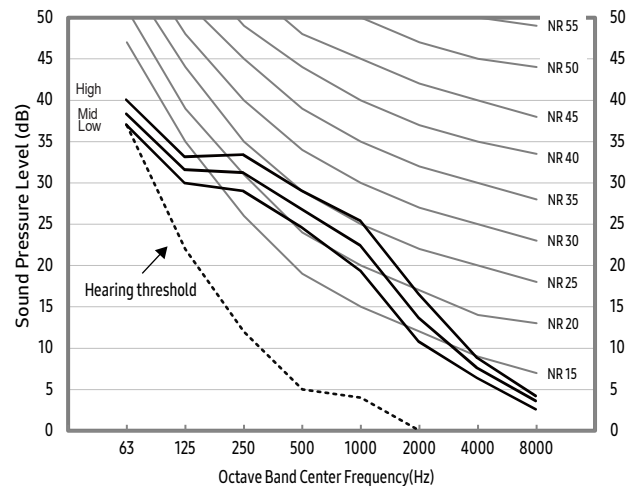

5 Sound Pressure Level

Slim Duct (Home)

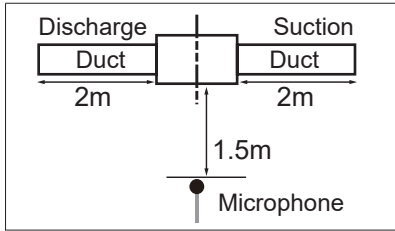

Unit: dB(A)

Model	High	Low
AM017KNLDEH/EU	25	19
AM022KNLDEH/EU	26	19
AM028KNLDEH/EU	28	19
AM036KNLDEH/EU	31	20

Note

Specifications may be subject to change without prior notice.
 Sound pressure level is obtained in an anechoic room.
 Sound pressure level is a relative value, depending on the distance and acoustic environment.
 Sound pressure level may differ depending on operation condition.
 dBA = A-weighted sound pressure level
 Reference acoustic pressure 0 dB= 20 uPa

NR curve

1) AM017KNLDEH/EU

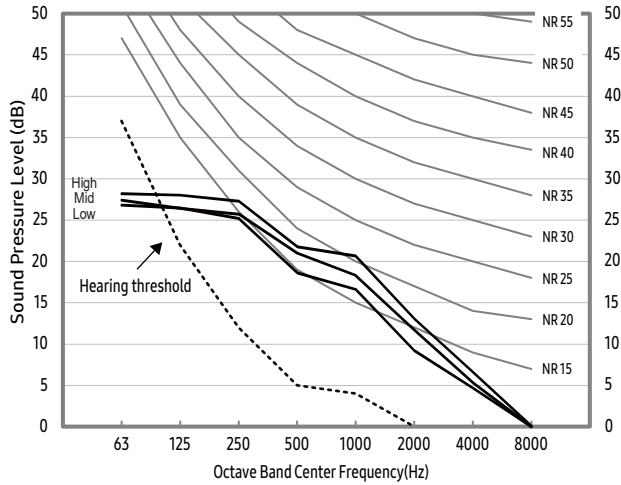

2) AM022KNLDEH/EU

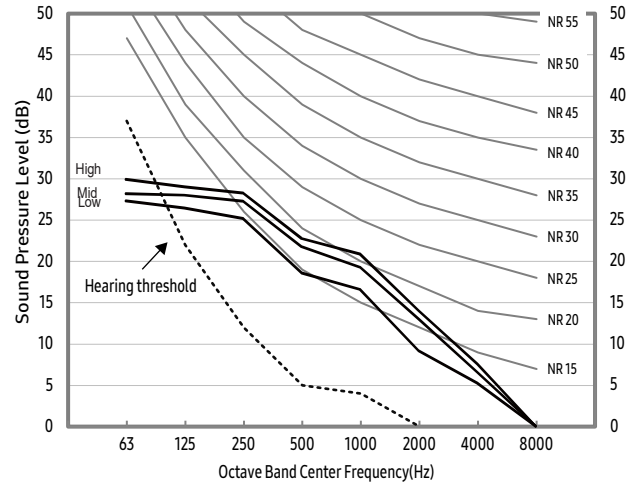

3) AM028KNLDEH/EU

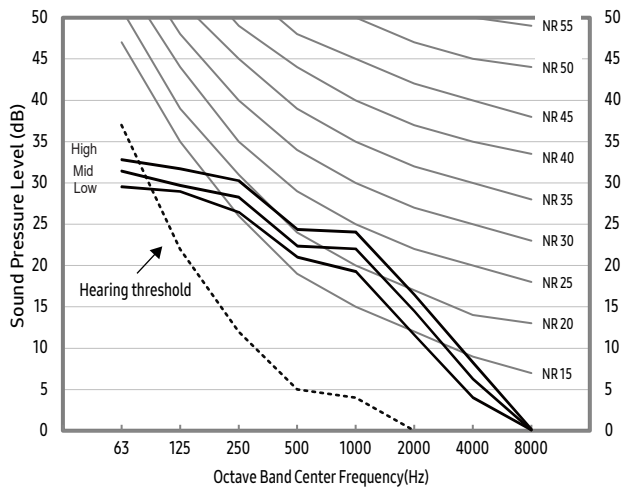

4) AM036KNLDEH/EU

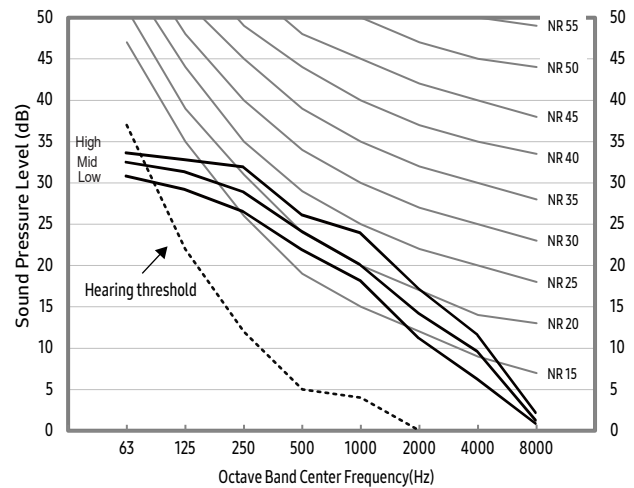

5 Sound Pressure Level

Slim Duct

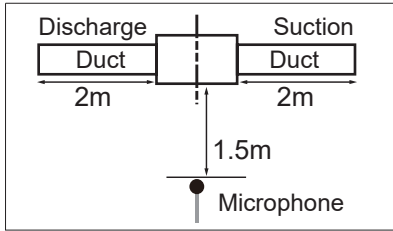

Unit: dB(A)

Model	High	Low
AM045*NLDEH***	35	26
AM056*NLDEH***	36	31
AM071*NLDEH***	38	33
AM090*NLDEH***	37	34

Note

Specifications may be subject to change without prior notice.
 Sound pressure level is obtained in an anechoic room.
 Sound pressure level is a relative value, depending on the distance and acoustic environment.
 Sound pressure level may differ depending on operation condition.
 dBA = A-weighted sound pressure level
 Reference acoustic pressure 0 dB= 20 uPa

NR curve

1) AM045*NLDEH***

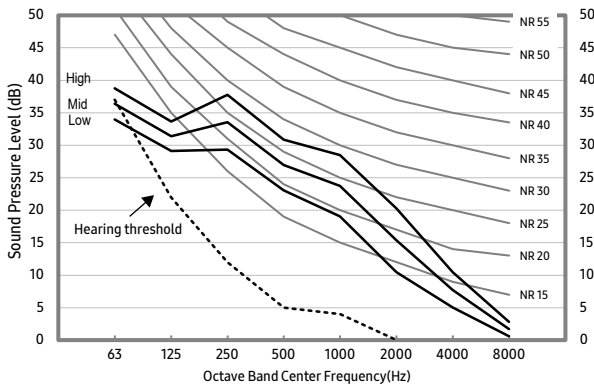

2) AM056*NLDEH***

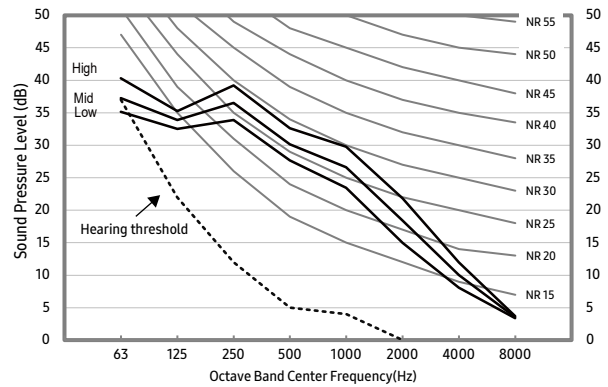

3) AM071*NLDEH***

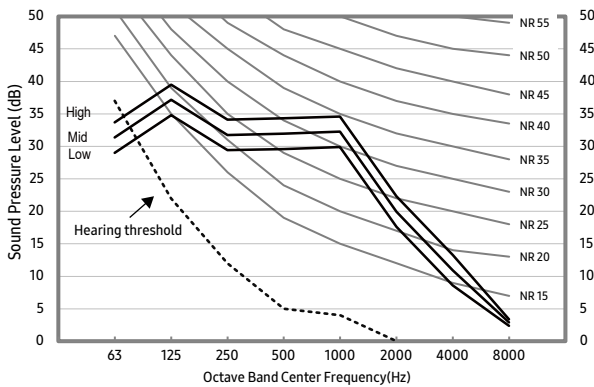

4) AM090*NLDEH***

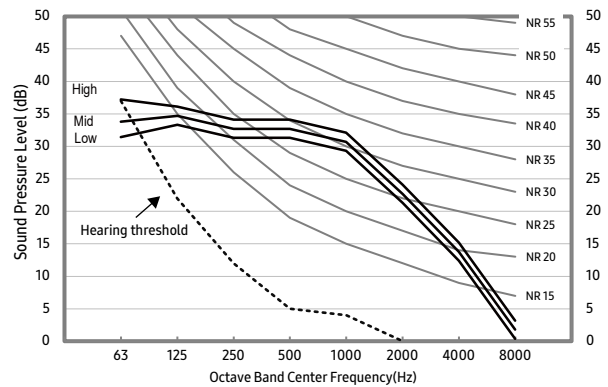

5 Sound Pressure Level

Slim Duct

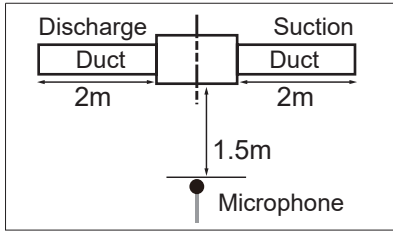

Unit: dB(A)

Model	High	Low
AM112*NLDEH***	37	34
AM128*NLDEH***	37	34
AM140*NLDEH***	39	36

Note

Specifications may be subject to change without prior notice.
 Sound pressure level is obtained in an anechoic room.
 Sound pressure level is a relative value, depending on the distance and acoustic environment.
 Sound pressure level may differ depending on operation condition.
 dBA = A-weighted sound pressure level
 Reference acoustic pressure 0 dB= 20 uPa

NR curve

5) AM112*NLDEH***

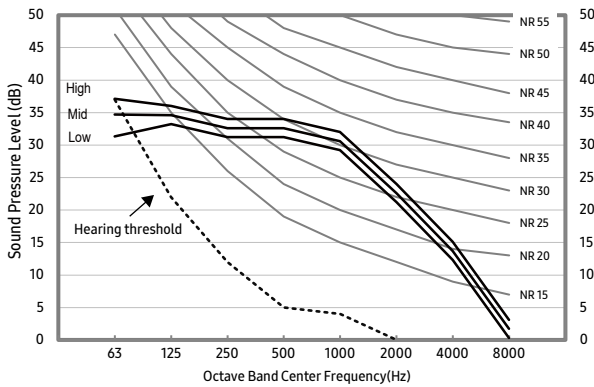

6) AM128*NLDEH***

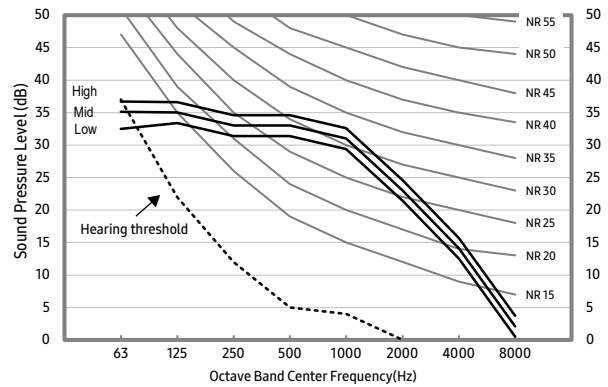

7) AM140*NLDEH***

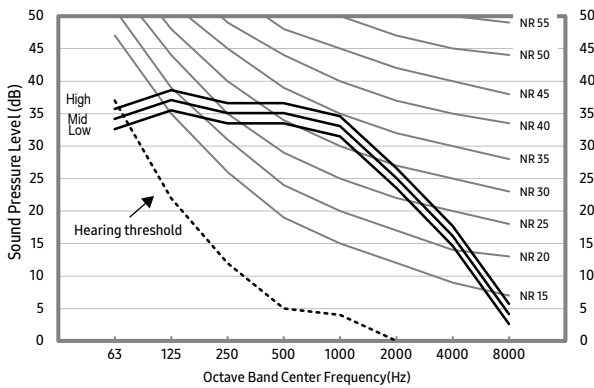

6 Sound Power Level

Slim Duct

Unit: dB(A)

Model	Power
AM017FNLDEH/EU	49
AM022FNLDEH/EU	49
AM028FNLDEH/EU	49
AM036FNLDEH/EU	51

Note

- . Specifications may be subject to change without prior notice.
- . Sound power level is an absolute value that a sound source generates.
- . dBA = A-weighted sound power level.
- . Reference power : 1pW.
- . Measured according to ISO 3741

1) AM017FNLDEH/EU

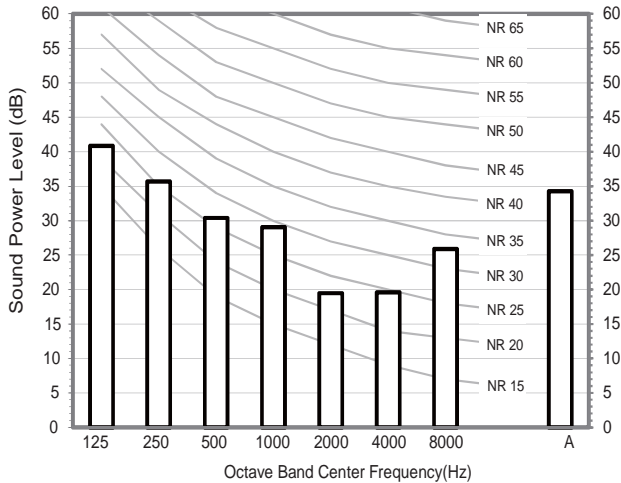

2) AM022FNLDEH/EU

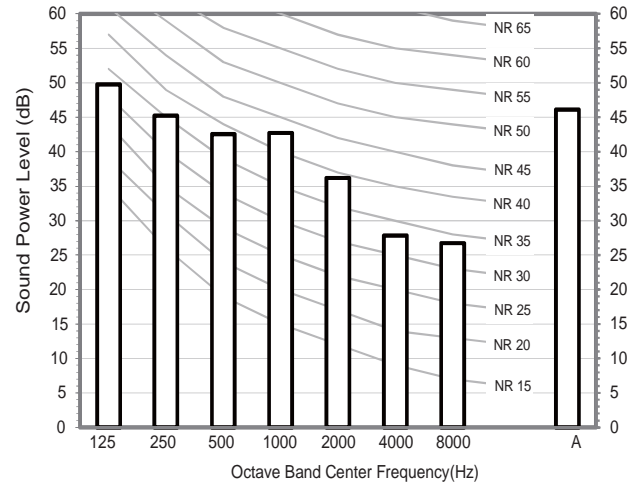

3) AM028FNLDEH/EU

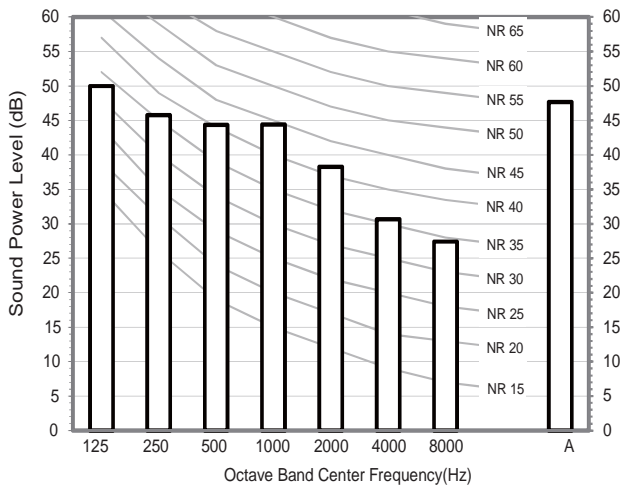

4) AM036FNLDEH/EU

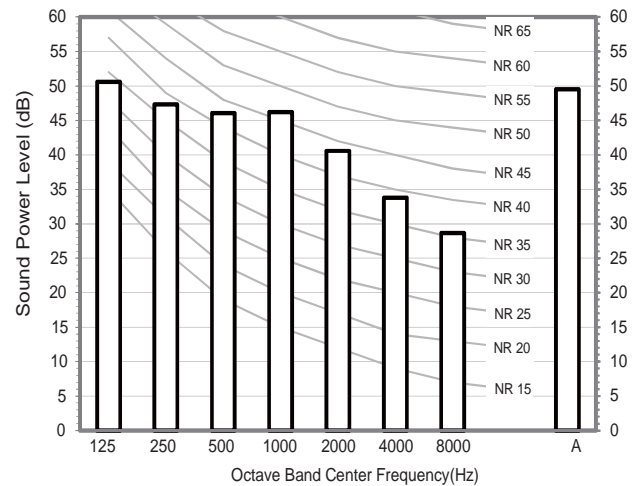

6 Sound Power Level

Slim Duct (Home)

Unit: dB(A)

Model	Power
AM017KNLDEH/EU	40
AM022KNLDEH/EU	42
AM028KNLDEH/EU	44
AM036KNLDEH/EU	46

Note

- . Specifications may be subject to change without prior notice.
- . Sound power level is an absolute value that a sound source generates.
- . dBA = A-weighted sound power level.
- . Reference power : 1pW.
- . Measured according to ISO 3741

1) AM017KNLDEH/EU

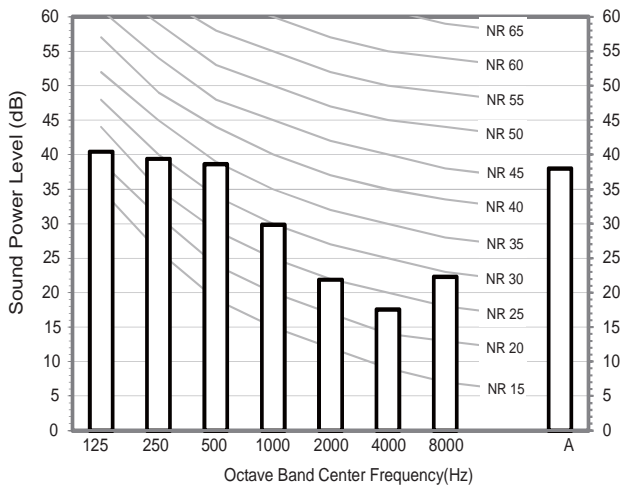

2) AM022KNLDEH/EU

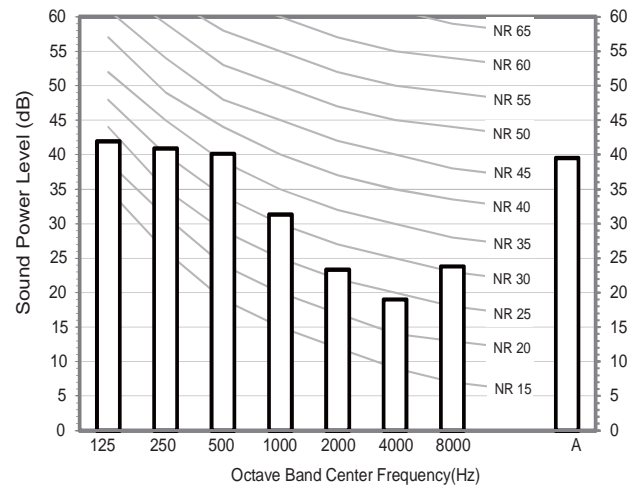

3) AM028KNLDEH/EU

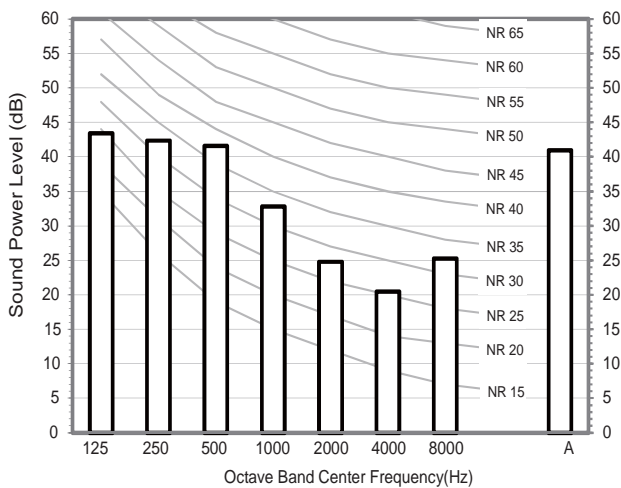

4) AM036KNLDEH/EU

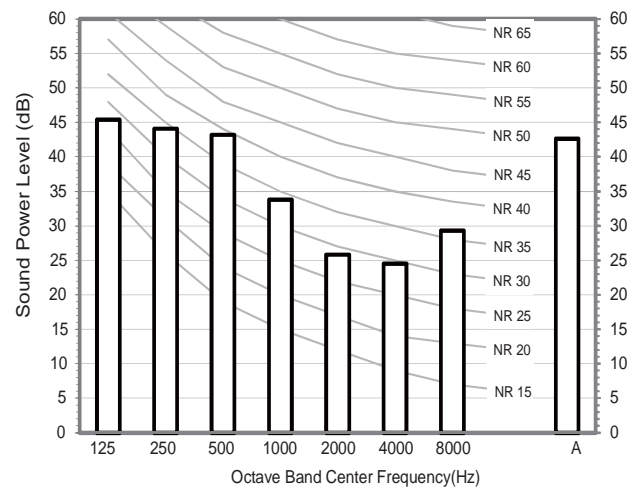

6 Sound Power Level

Slim Duct

Unit: dB(A)

Model	Power
AM045*NLDEH/EU	53
AM056*NLDEH/EU	55
AM071*NLDEH/EU	57
AM090*NLDEH/EU	66

Note

- . Specifications may be subject to change without prior notice.
- . Sound power level is an absolute value that a sound source generates.
- . dBA = A-weighted sound power level.
- . Reference power : 1pW.
- . Measured according to ISO 3741

1) AM045*NLDEH***

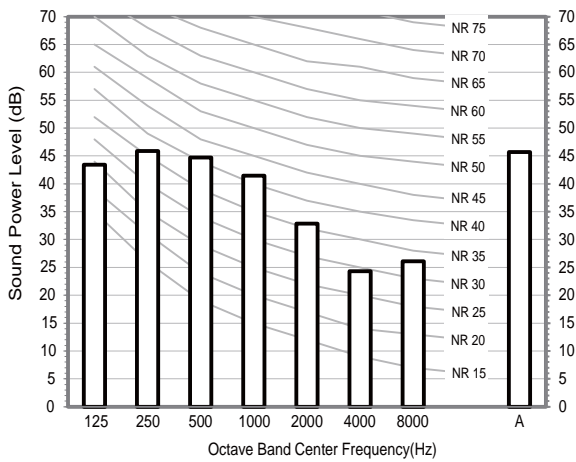

2) AM056*NLDEH***

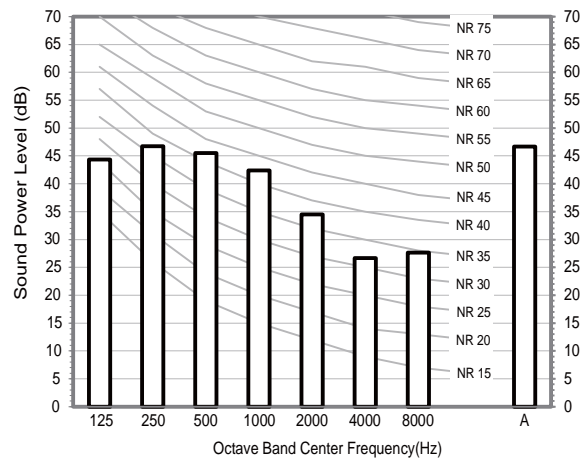

3) AM071*NLDEH***

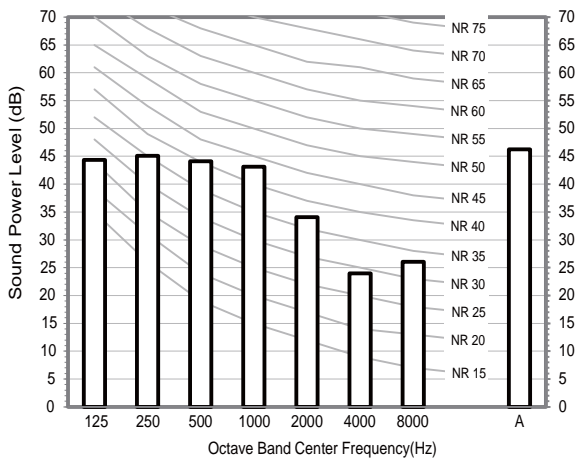

4) AM090*NLDEH***

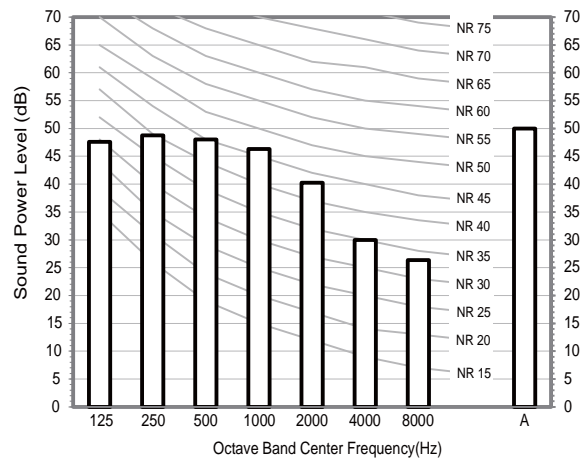

6 Sound Power Level

Slim Duct

Unit: dB(A)

Model	Power
AM112*NLDEH/EU	66
AM128*NLDEH/EU	66
AM140*NLDEH/EU	68

Note

- . Specifications may be subject to change without prior notice.
- . Sound power level is an absolute value that a sound source generates.
- . dBA = A-weighted sound power level.
- . Reference power : 1pW.
- . Measured according to ISO 3741

5) AM112*NLDEH***

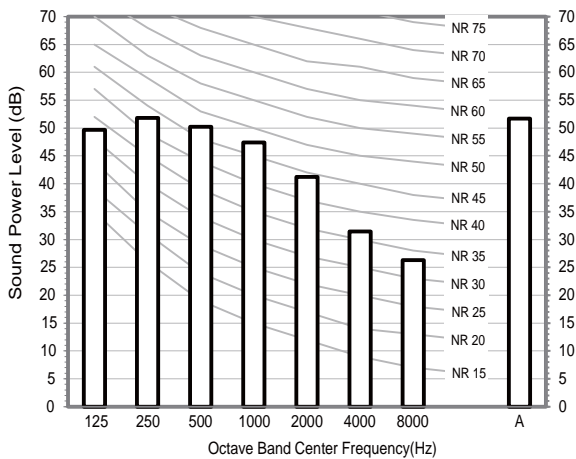

6) AM128*NLDEH***

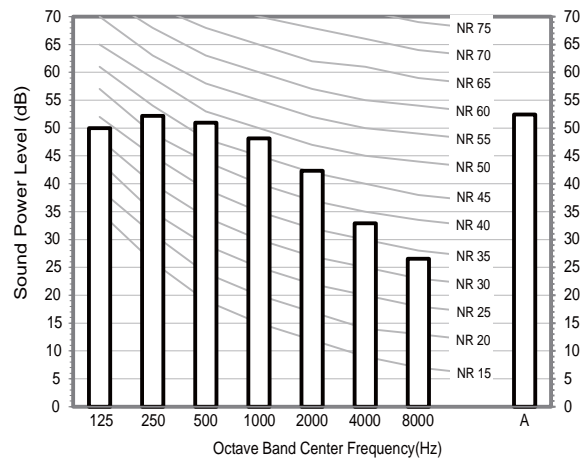

7) AM140*NLDEH***

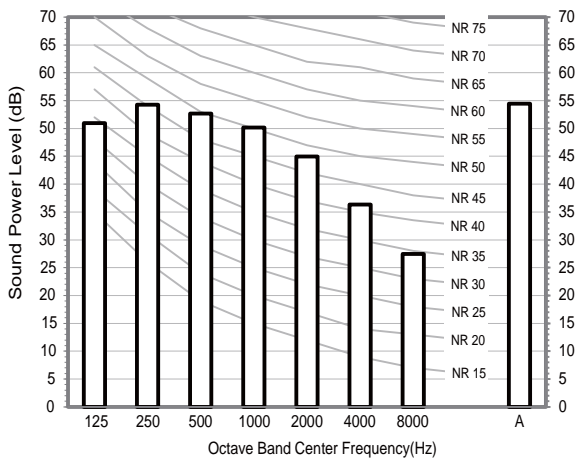

7 Fan Characteristics

Slim Duct

1) AM017FNLDEH/EU

①	External Static Pressure(mmAq)	Option Code
	$0 < SP \leq 0.5$	010054-12549E-201111-331110

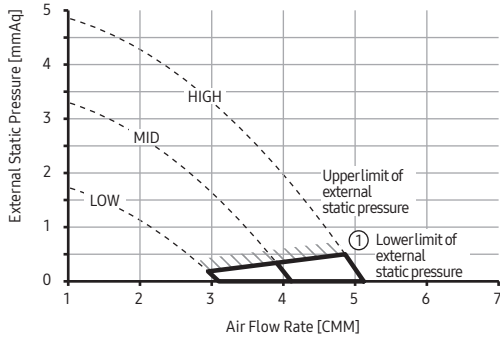

②	External Static Pressure(mmAq)	Option Code
	$0.5 < SP \leq 2$	010054-1255B1-201111-331110

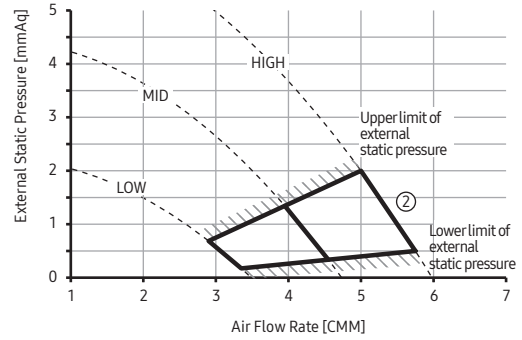

③	External Static Pressure(mmAq)	Option Code
	$2 < SP \leq 3$	010054-1255F5-201111-331110

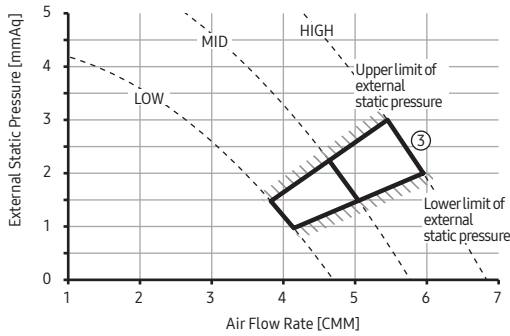

Note

Adjust option code according to the actual installation condition (external static pressure).

ESP = External Static Pressure

The graphs display the available external static pressure range of installed indoor units. Therefore, they do not reflect the actual change of external static pressure and airflow rate according to adjusted airflow (High-Mid-Low) of installed indoor units.

7 Fan Characteristics

Slim Duct

2) AM022FNLDEH/EU

①	External Static Pressure(mmAq)	Option Code
	$0 < SP \leq 0.5$	010054-125A80-201616-331110

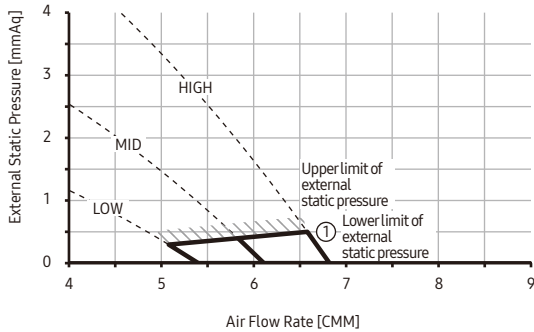

②	External Static Pressure(mmAq)	Option Code
	$0.5 < SP \leq 2$	010054-125AC3-201616-331110

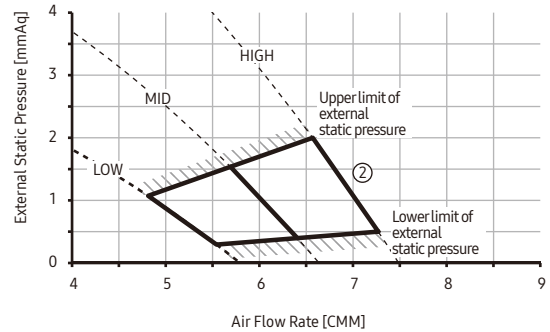

③	External Static Pressure(mmAq)	Option Code
	$2 < SP \leq 3$	010054-125E08-201616-331110

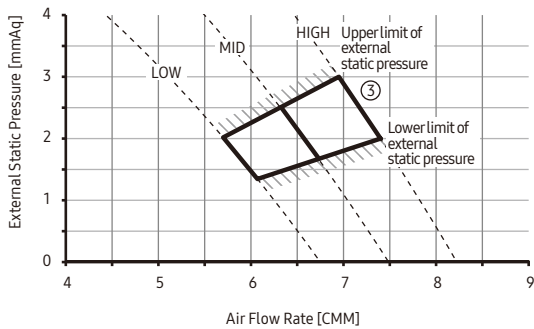

Note

Adjust option code according to the actual installation condition (external static pressure).

ESP = External Static Pressure

The graphs display the available external static pressure range of installed indoor units. Therefore, they do not reflect the actual change of external static pressure and airflow rate according to adjusted airflow (High-Mid-Low) of installed indoor units.

7 Fan Characteristics

Slim Duct

3) AM028FNLDEH/EU

①	External Static Pressure(mmAq)	Option Code
	$0 < SP \leq 0.5$	010054-125AE2-201C1C-331110

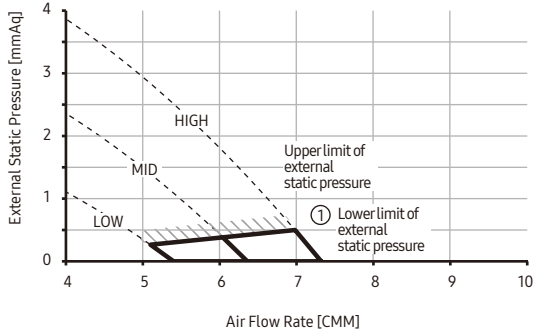

②	External Static Pressure(mmAq)	Option Code
	$0.5 < SP \leq 2$	010054-125E15-201C1C-331110

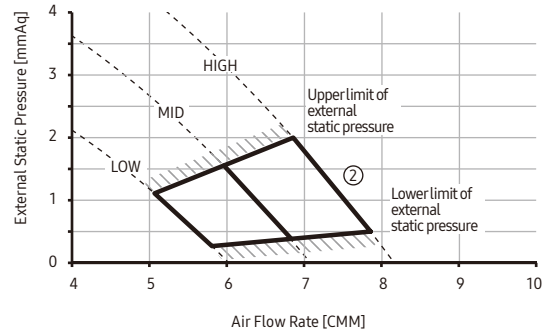

③	External Static Pressure(mmAq)	Option Code
	$2 < SP \leq 3$	010054-125E7A-201C1C-331110

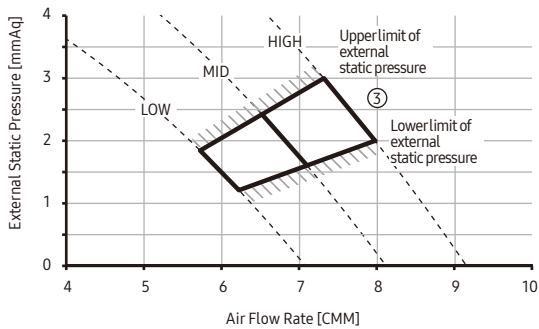

Note

Adjust option code according to the actual installation condition (external static pressure).

ESP = External Static Pressure

The graphs display the available external static pressure range of installed indoor units. Therefore, they do not reflect the actual change of external static pressure and airflow rate according to adjusted airflow (High-Mid-Low) of installed indoor units.

7 Fan Characteristics

Slim Duct

4) AM036FNLDEH/EU

①	External Static Pressure(mmAq)	Option Code
	$0 < SP \leq 0.5$	010054-125E35-202424-331110

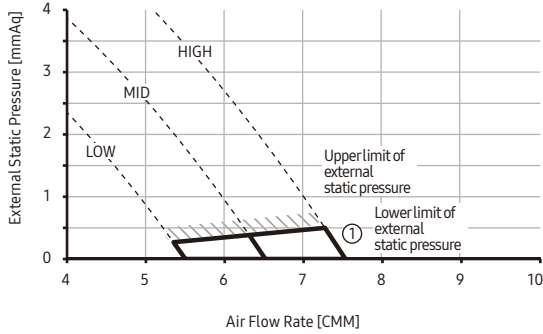

②	External Static Pressure(mmAq)	Option Code
	$0.5 < SP \leq 2$	010054-125E68-202424-331110

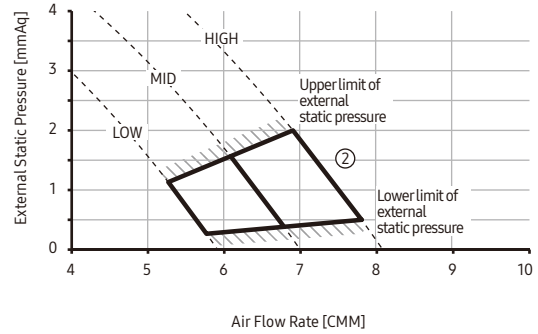

③	External Static Pressure(mmAq)	Option Code
	$2 < SP \leq 3$	010054-125ECD-202424-331110

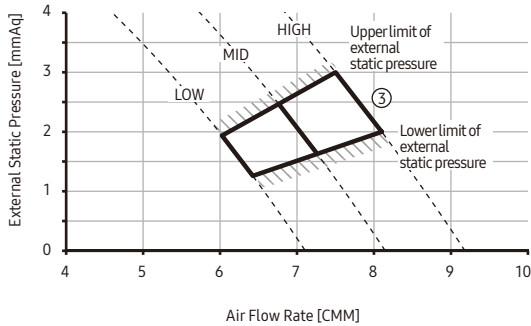

Note

Adjust option code according to the actual installation condition (external static pressure).

ESP = External Static Pressure

The graphs display the available external static pressure range of installed indoor units. Therefore, they do not reflect the actual change of external static pressure and airflow rate according to adjusted airflow (High-Mid-Low) of installed indoor units.

7 Fan Characteristics

Slim Duct

5) AM045*NLDEH/EU

①	External Static Pressure(mmAq)	Option Code
	$0 < SP \leq 1$	010054-12599F-202D2D-331110

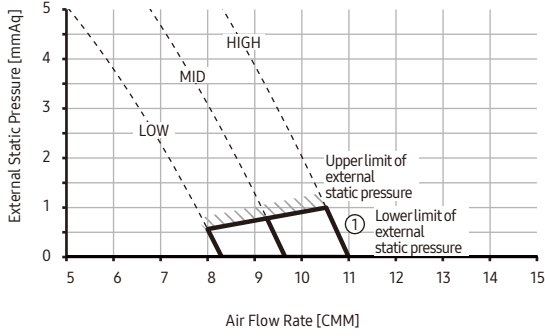

②	External Static Pressure(mmAq)	Option Code
	$1 < SP \leq 3$	010054-125AE2-202D2D-331110

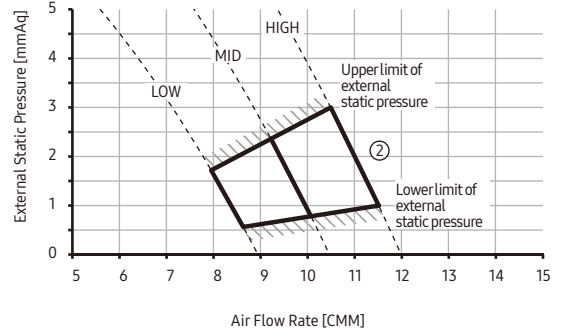

③	External Static Pressure(mmAq)	Option Code
	$3 < SP \leq 4$	010054-125EF6-202D2D-331110

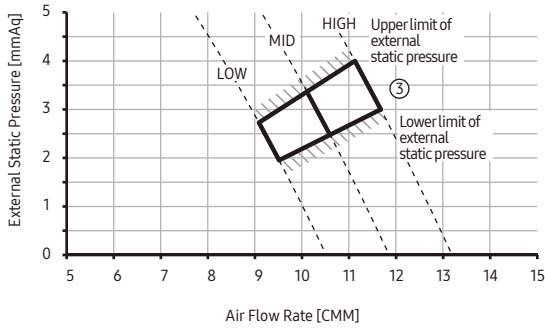

Note

Adjust option code according to the actual installation condition (external static pressure).

ESP = External Static Pressure

The graphs display the available external static pressure range of installed indoor units. Therefore, they do not reflect the actual change of external static pressure and airflow rate according to adjusted airflow (High-Mid-Low) of installed indoor units.

7 Fan Characteristics

Slim Duct

6) AM056*NLDEH/EU

①	External Static Pressure(mmAq)	Option Code
	$0 < SP \leq 1$	010054-125AC1-203838-331110

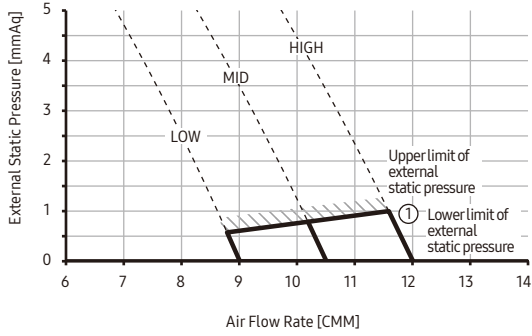

②	External Static Pressure(mmAq)	Option Code
	$1 < SP \leq 3$	010054-125E34-203838-331110

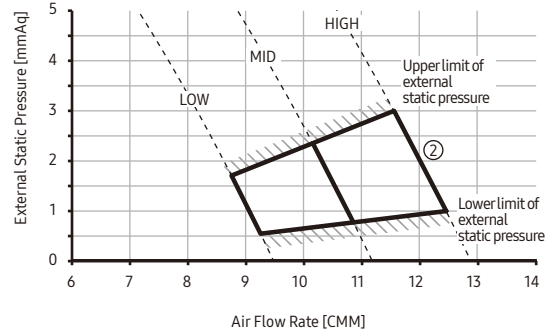

③	External Static Pressure(mmAq)	Option Code
	$3 < SP \leq 4$	010054-125EF9-203838-331110

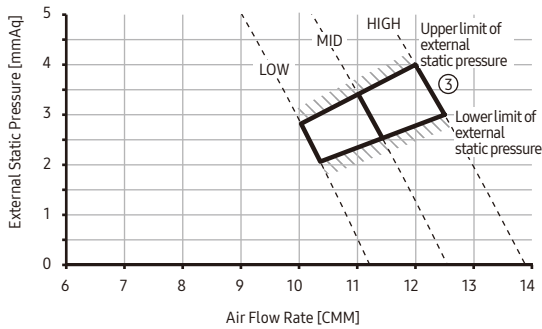

Note

Adjust option code according to the actual installation condition (external static pressure).

ESP = External Static Pressure

The graphs display the available external static pressure range of installed indoor units. Therefore, they do not reflect the actual change of external static pressure and airflow rate according to adjusted airflow (High-Mid-Low) of installed indoor units.

7 Fan Characteristics

Slim Duct

7) AM071*NLDEH/EU

①	External Static Pressure(mmAq)	Option Code
	$0 < SP \leq 1$	010054-1259BB-204747-331110

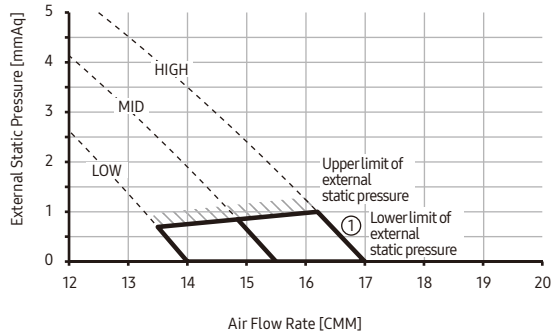

②	External Static Pressure(mmAq)	Option Code
	$1 < SP \leq 3$	010054-125D9E-204747-331110

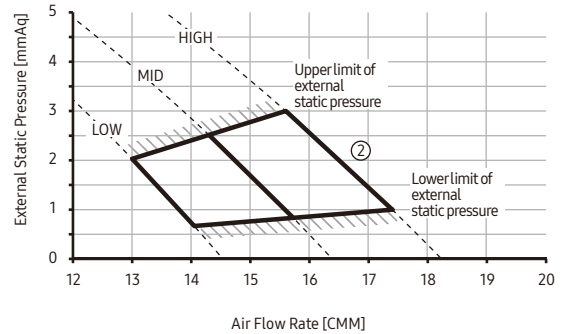

③	External Static Pressure(mmAq)	Option Code
	$3 < SP \leq 4$	010054-125EF4-204747-331110

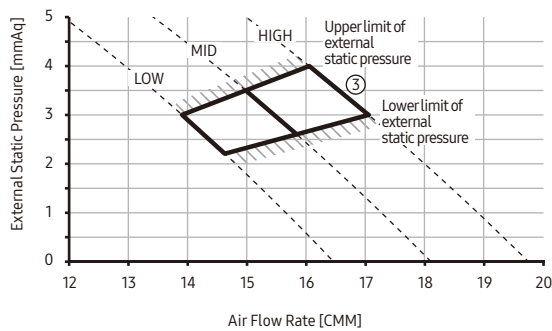

Note

Adjust option code according to the actual installation condition (external static pressure).

ESP = External Static Pressure

The graphs display the available external static pressure range of installed indoor units. Therefore, they do not reflect the actual change of external static pressure and airflow rate according to adjusted airflow (High-Mid-Low) of installed indoor units.

7 Fan Characteristics

Slim Duct

8) AM090*NLDEH/EU

①	External Static Pressure(mmAq)	Option Code
	$0 < SP \leq 1.5$	010054-1B596C-205A5A-331110

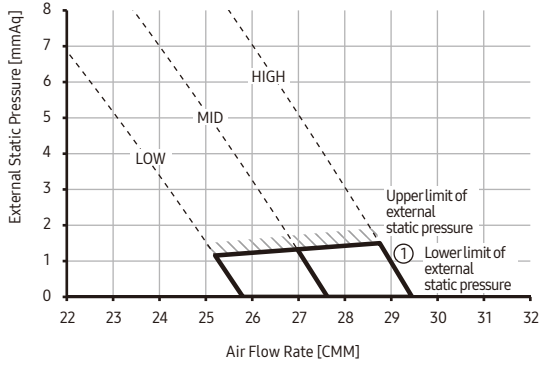

②	External Static Pressure(mmAq)	Option Code
	$1.5 < SP \leq 4.5$	010054-1B5AD4-205A5A-331110

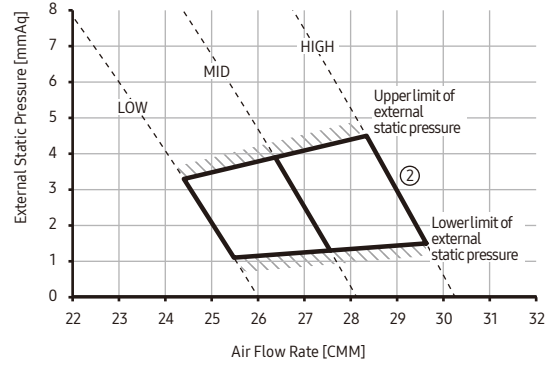

③	External Static Pressure(mmAq)	Option Code
	$4.5 < SP \leq 6$	010054-1B5E2A-205A5A-331110

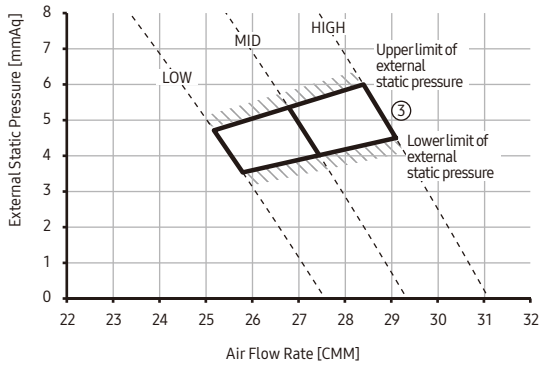

Note

Adjust option code according to the actual installation condition (external static pressure).

ESP = External Static Pressure

The graphs display the available external static pressure range of installed indoor units. Therefore, they do not reflect the actual change of external static pressure and airflow rate according to adjusted airflow (High-Mid-Low) of installed indoor units.

7 Fan Characteristics

Slim Duct

9) AM112*NLDEH/EU

①	External Static Pressure(mmAq)	Option Code
	$0 < SP \leq 1.5$	010054-1B596C-207070-331110

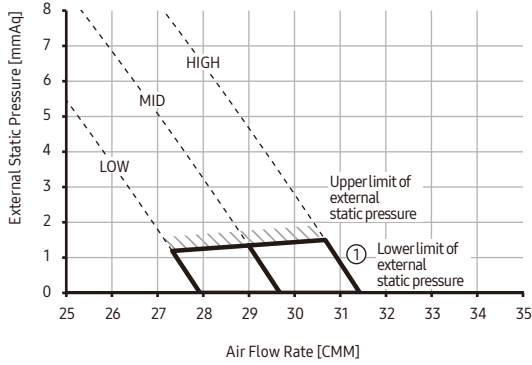

②	External Static Pressure(mmAq)	Option Code
	$1.5 < SP \leq 4.5$	010054-1B5AD4-207070-331110

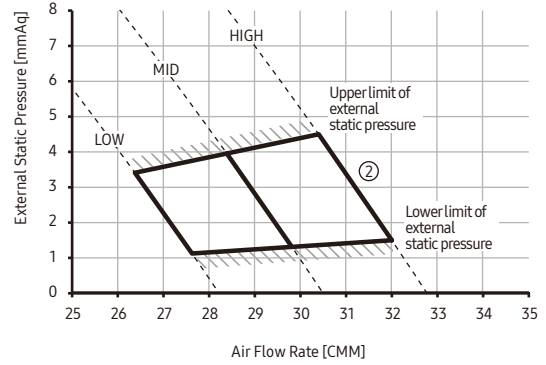

③	External Static Pressure(mmAq)	Option Code
	$4.5 < SP \leq 6$	010054-1B5E2A-207070-331110

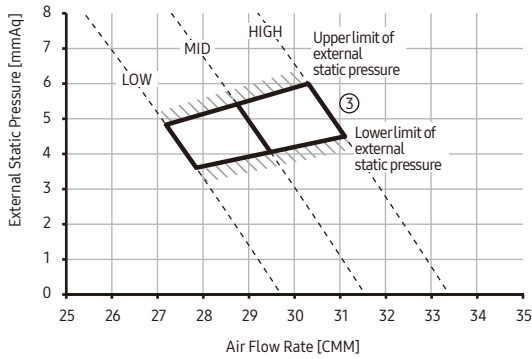

Note

Adjust option code according to the actual installation condition (external static pressure).

ESP = External Static Pressure

The graphs display the available external static pressure range of installed indoor units. Therefore, they do not reflect the actual change of external static pressure and airflow rate according to adjusted airflow (High-Mid-Low) of installed indoor units.

7 Fan Characteristics

Slim Duct

10) AM128*NLDEH/EU

①	External Static Pressure(mmAq)	Option Code
	$0 < SP \leq 1.5$	010054-1B5AF5-208080-331110

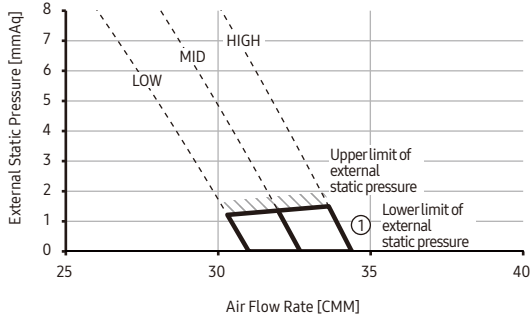

②	External Static Pressure(mmAq)	Option Code
	$1.5 < SP \leq 4.5$	010054-1B5E4B-208080-331110

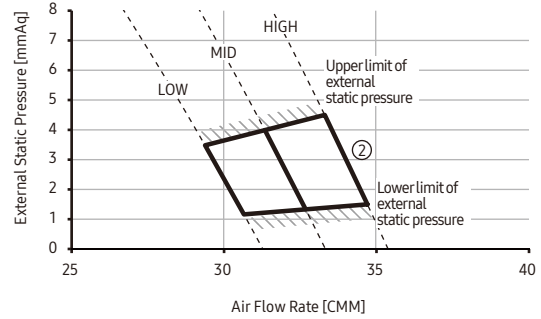

③	External Static Pressure(mmAq)	Option Code
	$4.5 < SP \leq 6$	010054-1B5E8F-208080-331110

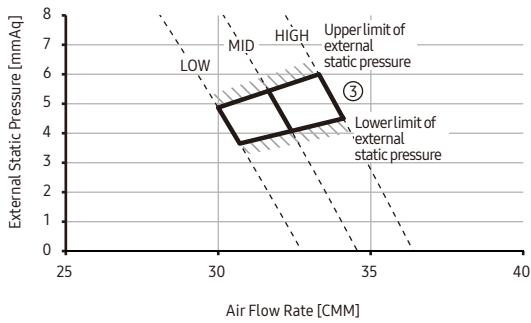

Note

Adjust option code according to the actual installation condition (external static pressure).

ESP = External Static Pressure

The graphs display the available external static pressure range of installed indoor units. Therefore, they do not reflect the actual change of external static pressure and airflow rate according to adjusted airflow (High-Mid-Low) of installed indoor units.

7 Fan Characteristics

Slim Duct

11) AM140*NLDEH/EU

①	External Static Pressure(mmAq)	Option Code
	$0 < SP \leq 1.5$	010054-1B5E34-208C8C-331110

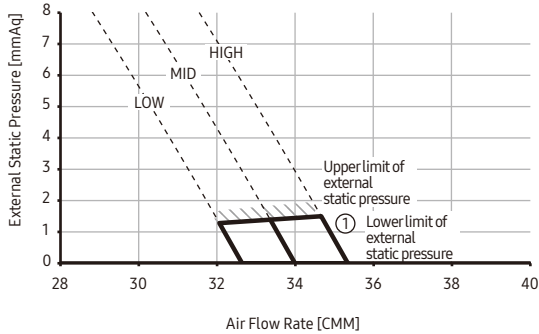

②	External Static Pressure(mmAq)	Option Code
	$1.5 < SP \leq 4.5$	010054-1B5E7F-208C8C-331110

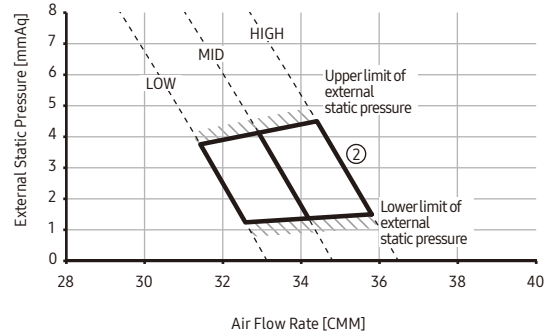

③	External Static Pressure(mmAq)	Option Code
	$4.5 < SP \leq 6$	010054-1B5FC3-208C8C-331110

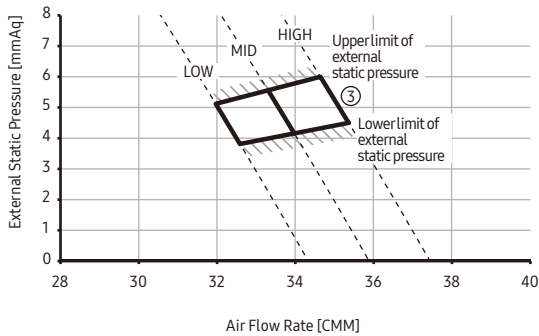

Note

Adjust option code according to the actual installation condition (external static pressure).

ESP = External Static Pressure

The graphs display the available external static pressure range of installed indoor units. Therefore, they do not reflect the actual change of external static pressure and airflow rate according to adjusted airflow (High-Mid-Low) of installed indoor units.

7 Fan Characteristics

Slim Duct (Home)

12) AM017KNLDEH/EU

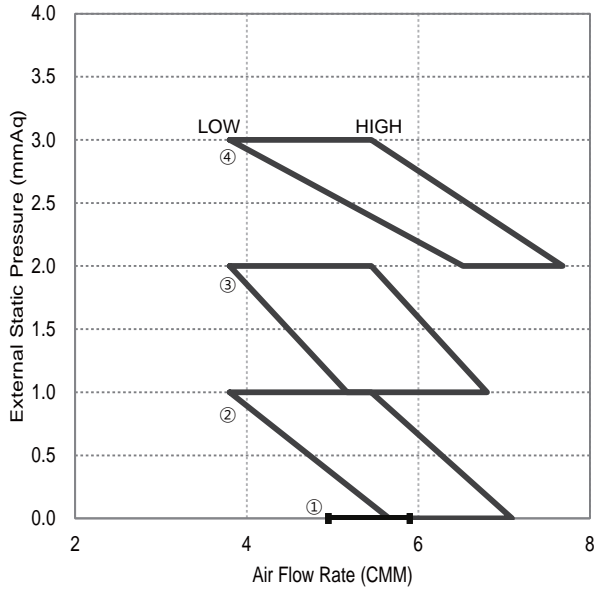

Exelmal Static Pressure (mmAq)	Option code
① 0	010054-1C9062-201212-331110
② 0 < P ≤ 1 (Default)	010054-1C90B5-201212-331110
③ 1 < P ≤ 2	010054-1C940A-201212-331110
④ 2 < P ≤ 3	010054-1C9584-201212-331110

13) AM022KNLDEH/EU

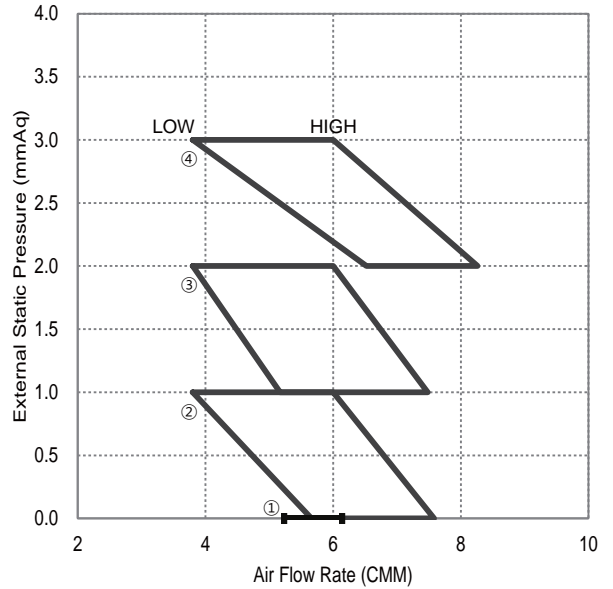

Exelmal Static Pressure (mmAq)	Option code
① 0	010054-1C9073-201616-331110
② 0 < P ≤ 1 (Default)	010054-1C90D5-201616-331110
③ 1 < P ≤ 2	010054-1C942A-201616-331110
④ 2 < P ≤ 3	010054-1C95A4-201616-331110

14) AM028KNLDEH/EU

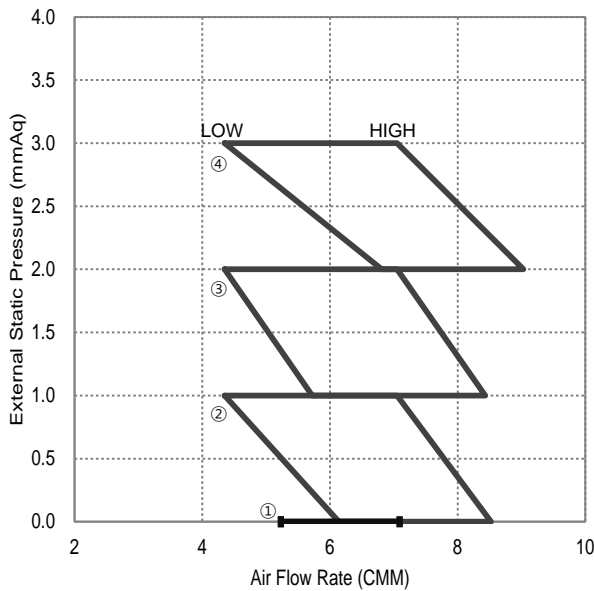

Exelmal Static Pressure (mmAq)	Option code
① 0	010054-1C90B3-201C1C-331110
② 0 < P ≤ 1 (Default)	010054-1C9417-201C1C-331110
③ 1 < P ≤ 2	010054-1C946C-201C1C-331110
④ 2 < P ≤ 3	010054-1C95C5-201C1C-331110

15) AM036KNLDEH/EU

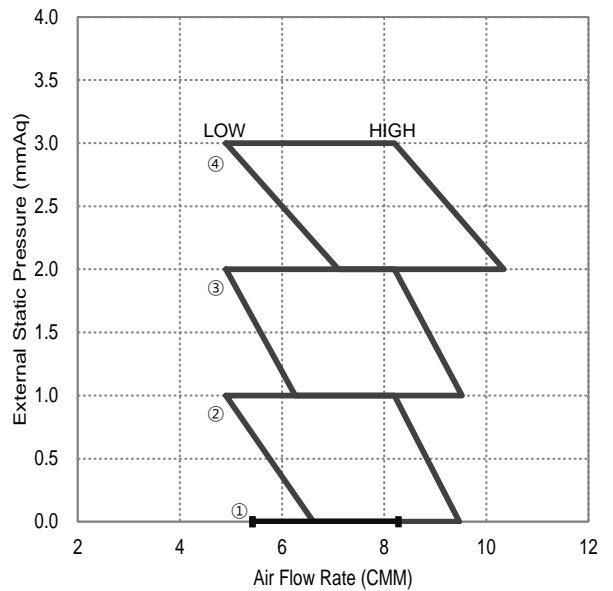

Exelmal Static Pressure (mmAq)	Option code
① 0	010054-1C9404-202424-331110
② 0 < P ≤ 1 (Default)	010054-1C9459-202424-331110
③ 1 < P ≤ 2	010054-1C94AE-202424-331110
④ 2 < P ≤ 3	010054-1C9916-202424-331110

MSP Duct

- 1 *Specifications*
- 2 *Capacity Table*
- 3 *Dimensional Drawing*
- 4 *Electrical Wiring Diagram*
- 5 *Sound Pressure Level*
- 6 *Sound Power Level*
- 7 *Fan Characteristics*

1 Specifications

MSP Duct

Model				AM022FNMDEH/EU	AM028FNMDEH/EU	AM036FNMDEH/EU	AM045FNMDEH/EU	AM056FNMDEH/EU
Power Supply			Ø, #, V, Hz	1,2,220-240,50	1,2,220-240,50	1,2,220-240,50	1,2,220-240,50	1,2,220-240,50
Mode			-	HP/HR	HP/HR	HP/HR	HP/HR	HP/HR
Performance	Capacity (Nominal)	Cooling	kW	2.2	2.8	3.6	4.5	5.6
			Btu/h	7,500	9,600	12,300	15,400	19,100
		Heating	kW	2.5	3.2	4.0	5.0	6.3
			Btu/h	8,500	10,900	13,600	17,100	21,500
Power	Power Input (Nominal)	Cooling	W	80	80	85	125	130
		Heating		80	80	85	125	130
	Current Input (Nominal)	Cooling	A	0.40	0.40	0.55	1.15	1.10
		Heating		0.40	0.40	0.55	1.15	1.10
Fan	Motor	Type	-	Sirocco Fan	Sirocco Fan	Sirocco Fan	Sirocco Fan	Sirocco Fan
		Output	W	25	25	50	200	200
		Number of unit	EA	1	1	1	1	1
	Air Flow Rate	H/M/L (UL)	CMM	8.50/7.50/6.30	10.00/9.20/7.50	12.00/10.20/8.80	14.00/12.00/10.50	14.50/13.00/11.50
			l/s	141.67/125.00/105.00	166.67/153.33/125.00	200.00/170.00/146.67	233.33/200.00/175.00	241.67/216.67/191.67
	External Static Pressure	Mid/Std/Max	mmAq	0.00/2.00/6.00	0.00/2.00/6.00	0.00/2.00/6.00	0.00/4.00/8.00	0.00/4.00/8.00
			Pa	0.00/19.61/58.84	0.00/19.61/58.84	0.00/19.61/58.84	0.00/39.23/78.45	0.00/39.23/78.45
WG			0/0.079/0.236	0/0.079/0.236	0/0.079/0.236	0/0.157/0.314	0/0.157/0.314	
Option Code			-	010054-1350EA-201616-331110	010054-13542C-201C1C-331110	010054-1350F8-202424-331110	010054-125583-202D2D-331110	010054-1255C5-203838-331110
Piping Connections	Liquid Pipe	Ø, mm	6.35	6.35	6.35	6.35	6.35	
		Ø, inch	1/4	1/4	1/4	1/4	1/4	
	Gas Pipe	Ø, mm	12.70	12.70	12.70	12.70	12.70	
		Ø, inch	1/2	1/2	1/2	1/2	1/2	
Drain Pipe	Ø, mm	VP25 (OD 32,ID 25)	VP25 (OD 32,ID 25)	VP25 (OD 32,ID 25)	VP25 (OD 32,ID 25)	VP25 (OD 32,ID 25)		
Field Wiring	Power Source Wire	Below 20m/ over 20m	mm ²	1.5/2.5	1.5/2.5	1.5/2.5	1.5/2.5	1.5/2.5
	Transmission Cable		mm ²	0.75~1.5	0.75~1.5	0.75~1.5	0.75~1.5	0.75~1.5
Refrigerant	Type	-	-	R410A	R410A	R410A	R410A	R410A
	Control Method	-	-	EEV INCLUDED	EEV INCLUDED	EEV INCLUDED	EEV INCLUDED	EEV INCLUDED
Sound	Sound pressure	High / Mid / Low	dBA	23 / 21 / 19	24 / 22 / 19	29 / 27 / 24	32 / 30 / 28	35 / 33 / 31
Dimensions	Net Weight		kg	23.5	23.5	23.5	28.0	28.0
	Shipping Weight		kg	28.5	28.5	28.5	32.5	32.5
	Net Dimensions (WxHxD)		mm	900 x 199 x 600	900 x 199 x 600	900 x 199 x 600	900 x 260 x 480	900 x 260 x 480
	Shipping Dimensions (WxHxD)		mm	1150 x 280 x 710	1150 x 280 x 710	1150 x 280 x 710	1170 x 340 x 595	1170 x 340 x 595
Panel Size	Panel Model		-	-	-	-	-	-
	Net Weight		kg	-	-	-	-	-
	Shipping Weight		kg	-	-	-	-	-
	Net Dimensions (WxHxD)		mm	-	-	-	-	-
	Shipping Dimensions (WxHxD)		mm	-	-	-	-	-
Additional Accessories	Drain Pump	Drain Pump	-	MDP-E075SEE3D	MDP-E075SEE3D	MDP-E075SEE3D	MDP-M075SGU3D	MDP-M075SGU3D
		Max. Lifting Height/ Displacement	mm/liter/h	750 / 24	750 / 24	750 / 24	750 / 24	750 / 24
	Air Filter		-	Long life filter	Long life filter	Long life filter	Long life filter	Long life filter

NOTE

- 1) Mode : HP(Heat Pump), HR(Heat Recovery)
 - 2) Nominal Cooling : Indoor temperature 27°CDB / 19°CWB, Outdoor temperature 35°CDB/24°CWB, Refrigerant pipe length 7.5m, Level difference 0m.
 - 3) Nominal Heating : Indoor temperature 20°CDB / 15°CWB, Outdoor temperature 7°CDB / 6°CWB, Refrigerant pipe length 7.5m, Level difference 0m.
 - 4) Sound level was acquired in an anechoic room. Thus actual noise level may be different depending on the installation conditions.
 - 5) These products contain R410A which is fluorinated greenhouse gas.
 - 6) Specifications may be subject to change without prior notice.
- * Heat Exchanger type : Fin & Tube (Fin : Al, Tube : Cu)

1 Specifications

MSP Duct

Model				AM071FNMDHEH/EU	AM090FNMDHEH/EU	AM112FNMDHEH/EU	AM128FNMDHEH/EU	AM140FNMDHEH/EU
Power Supply			Ø, #, V, Hz	1,2,220-240,50	1,2,220-240,50	1,2,220-240,50	1,2,220-240,50	1,2,220-240,50
Mode			-	HP/HR	HP/HR	HP/HR	HP/HR	HP/HR
Performance	Capacity (Nominal)	Cooling	kW	7.1	9.0	11.2	12.8	14.0
			Btu/h	24,200	30,700	38,200	43,700	47,800
		Heating	kW	8.0	10.0	12.5	13.8	16.0
			Btu/h	27,300	34,100	42,700	47,100	54,600
Power	Power Input (Nominal)	Cooling	W	190	240	260	370	410
		Heating		190	240	260	370	410
	Current Input (Nominal)	Cooling	A	1.25	1.30	1.17	1.67	1.86
		Heating		1.25	1.30	1.17	1.67	1.86
Fan	Motor	Type	-	Sirocco Fan	Sirocco Fan	Sirocco Fan	Sirocco Fan	Sirocco Fan
		Output	W	200	200	130	218	218
		Number of unit	EA	1	1	1	1	1
	Air Flow Rate	H/M/L (UL)	CMM	18.50/17.00/15.50	19.50/18.00/16.50	27.00/25.00/23.00	32.00/30.00/28.00	37.00/34.00/31.00
			l/s	308.33/283.33/258.33	325.00/300.00/275.00	450.00/416.67/383.33	533.33/500.00/466.67	616.67/566.67/516.67
	External Static Pressure	Mid/Std/Max	mmAq	0.00/4.00/8.00	4.00/6.00/8.00	4.00/8.00/12.00	4.00/8.00/14.00	4.00/8.00/14.00
			Pa	0.00/39.23/78.45	39.23/58.84/78.45	39.23/78.45/117.68	39.23/78.45/137.29	39.23/78.45/137.29
WG			0/0.157/0.314	0.157/0.236/0.315	0.236/0.314/0.472	0.236/0.314/0.553	0.236/0.314/0.553	
Option Code			-	010054-125979-204747-331110	010054-125D29-205A5A-331110	010054-122EBB-207070-331110	010054-122A80-208080-331110	010054-122E24-208C8C-331110
Piping Connections	Liquid Pipe	Ø, mm	9.52	9.52	9.52	9.52	9.52	
		Ø, inch	3/8	3/8	3/8	3/8	3/8	
	Gas Pipe	Ø, mm	15.88	15.88	15.88	15.88	15.88	
		Ø, inch	5/8	5/8	5/8	5/8	5/8	
Drain Pipe	Ø, mm	VP25 (OD 32,ID 25)	VP25 (OD 32,ID 25)	VP25 (OD 32,ID 25)	VP25 (OD 32,ID 25)	VP25 (OD 32,ID 25)		
Field Wiring	Power Source Wire	Below 20m/ over 20m	mm ²	1.5/2.5	1.5/2.5	1.5/2.5	1.5/2.5	1.5/2.5
	Transmission Cable		mm ²	0.75~1.5	0.75~1.5	0.75~1.5	0.75~1.5	0.75~1.5
Refrigerant	Type	-	-	R410A	R410A	R410A	R410A	R410A
	Control Method	-	-	EEV INCLUDED	EEV INCLUDED	EEV INCLUDED	EEV INCLUDED	EEV INCLUDED
Sound	Sound pressure	High / Mid / Low	dBA	39 / 35 / 31	40 / 37 / 34	41 / 40 / 38	41 / 40 / 38	42 / 39 / 36
Dimensions	Net Weight		kg	28.0	32.0	35.5	48.0	48.0
	Shipping Weight		kg	32.5	36.0	40.5	56.0	56.0
	Net Dimensions (WxHxD)		mm	900 x 260 x 480	1150 x 260 x 480	1150 x 320 x 480	1200 x 360 x 650	1200 x 360 x 650
	Shipping Dimensions (WxHxD)		mm	1170 x 340 x 595	1420 x 340 x 595	1420 x 400 x 595	1480 x 420 x 790	1480 x 420 x 790
Panel Size	Panel Model		-	-	-	-	-	-
	Net Weight		kg	-	-	-	-	-
	Shipping Weight		kg	-	-	-	-	-
	Net Dimensions (WxHxD)		mm	-	-	-	-	-
	Shipping Dimensions (WxHxD)		mm	-	-	-	-	-
Additional Accessories	Drain Pump	Drain Pump	-	MDP-M075SGU3D	MDP-M075SGU1D	MDP-M075SGU1D	MDP-M075SGU2D	MDP-M075SGU2D
		Max. Lifting Height/ Displacement	mm/liter/h	750 / 24	750 / 24	750 / 24	750 / 24	750 / 24
	Air Filter		-	Long life filter	Long life filter	Long life filter	Long life filter	Long life filter

NOTE

- 1) Mode : HP(Heat Pump), HR(Heat Recovery)
 - 2) Nominal Cooling : Indoor temperature 27°CDB / 19°CWB, Outdoor temperature 35°CDB/24°CWB, Refrigerant pipe length 7.5m, Level difference 0m.
 - 3) Nominal Heating : Indoor temperature 20°CDB / 15°CWB, Outdoor temperature 7°CDB / 6°CWB, Refrigerant pipe length 7.5m, Level difference 0m.
 - 4) Sound level was acquired in an anechoic room. Thus actual noise level may be different depending on the installation conditions.
 - 5) These products contain R410A which is fluorinated greenhouse gas.
 - 6) Specifications may be subject to change without prior notice.
- * Heat Exchanger type : Fin & Tube (Fin : Al, Tube : Cu)

1 Specifications

MSP Duct

Type			MSP Duct		
Model			AM160KNMDEH/EU		
Power Supply		Ø, #, V, Hz	1,2,220-240,50		
Mode			- HP/HR		
Performance	Capacity (Nominal)	Cooling	kW	16.00	
			Btu/h	54,600	
		Heating	kW	18.00	
			Btu/h	61,400	
Power	Power Input (Nominal)	Cooling	W	485.00	
		Heating	W	485.00	
	Current Input (Nominal)	Cooling	A	2.24	
		Heating	A	2.24	
Fan	Motor	Type	-	Sirocco Fan	
		Output x n	w	370 x 1	
	Air Flow Rate	H/M/L (UL)	CMM	43.00 / 38.00 / 30.50	
			l/s	716.67 / 633.33 / 508.33	
	External Pressure	Min/Std/Max	mmAq	4.00 / 8.00 / 14.00	
Pa			39.20 / 78.40 / 137.20		
Piping Connections	Liquid Pipe	Ø, mm	9.52		
		Ø, inch	3/8"		
	Gas Pipe	Ø, mm	15.88		
		Ø, inch	5/8"		
Drain Pipe	Ø, mm	VP25 (OD 32,ID 25)			
Field Wiring	Power Source Wire	mm ²	1.5 - 2.5		
	Transmission Cable	mm ²	0.75 - 1.50		
Refrigerant	Type	-	R410A		
	Control Method	-	EEV INCLUDED		
Sound	Pressure	High / Mid / Low	dB(A)	43 / 40 / 36	
	Power	Cooling		69	
Dimension	Net Weight		kg	50.0	
	Shipping Weight		kg	58.0	
	Net Dimensions (WxHxD)		mm	1,200 x 360 x 650	
	Shipping Dimensions (WxHxD)		mm	1,480 x 420 x 790	
Panel Size	Panel model		-	-	
	Panel Net Weight		kg	-	
	Shipping Weight		kg	-	
	Net Dimensions (WxHxD)		mm	-	
	Shipping Dimensions (WxHxD)		mm	-	
Additional Accessories	Drain Pump	Drain Pump	- / Model	MDP-M075SGU2D	
		Max. lifting Height / Displacement	mm/liter/h	-	
	Air Filter		-	-	

NOTE

- 1) Mode : HP(Heat Pump), HR(Heat Recovery)
 - 2) Nominal Cooling : Indoor temperature 27°CDB / 19°CWB, Outdoor temperature 35°CDB/24°CWB, Refrigerant pipe length 7.5m, Level difference 0m.
 - 3) Nominal Heating : Indoor temperature 20°CDB / 15°CWB, Outdoor temperature 7°CDB / 6°CWB, Refrigerant pipe length 7.5m, Level difference 0m.
 - 4) Sound level was acquired in an anechoic room. Thus actual noise level may be different depending on the installation conditions.
 - 5) These products contain R410A which is fluorinated greenhouse gas.
 - 6) Specifications may be subject to change without prior notice.
- * Heat Exchanger type : Fin & Tube (Fin : Al, Tube : Cu)

1 Specifications

MSP Duct

Type				MSP DUCT	MSP DUCT	MSP DUCT
Model				AM022KNMDEH/EU	AM028KNMDEH/EU	AM036KNMDEH/EU
Power Supply			Φ, #, V, Hz	1,2,220-240,50	1,2,220-240,50	1,2,220-240,50
Mode			-	HP/HR	HP/HR	HP/HR
Performance	Capacity (Nominal)	Cooling	kW	2.20	2.80	3.60
			Btu/h	7,500	9,600	12,300
		Heating	kW	2.50	3.20	4.00
			Btu/h	8,500	10,900	13,600
Power	Power Input (Nominal)	Cooling	W	80.00	80.00	85.00
		Heating		80.00	80.00	85.00
	Current Input (Nominal)	Cooling	A	0.40	0.40	0.55
		Heating		0.40	0.40	0.55
Fan	Type		-	Sirocco Fan	Sirocco Fan	Sirocco Fan
	Motor	Output x n	W	25 x 1	25 x 1	50 x 1
	Air Flow Rate	H/M/L (UL)	CMM	8.50/7.50/6.30	10.00/9.20/7.50	12.00/10.20/8.80
			l/s	141.67/125.00/105.00	166.67/153.33/125.00	200.00/170.00/146.67
	External Static Pressure	Min / Std / Max	mmAq	0.00/2.00/6.00	0.00/2.00/6.00	0.00/2.00/6.00
			Pa	0.00/19.61/58.84	0.00/19.61/58.84	0.00/19.61/58.84
Piping Connections	Liquid Pipe		Φ,mm	6.35	6.35	6.35
			Φ, inch	1/4"	1/4"	1/4"
	Gas Pipe		Φ,mm	12.70	12.70	12.70
			Φ, inch	1/2"	1/2"	1/2"
Drain Pipe		Φ,mm	VP25 (OD 32,ID 25)	VP25 (OD 32,ID 25)	VP25 (OD 32,ID 25)	
Field Wiring	Power Source Wire		mm ²	1.5 ~ 2.5	1.5 ~ 2.5	1.5 ~ 2.5
	Transmission Cable		mm ²	0.75 ~ 1.50	0.75 ~ 1.50	0.75 ~ 1.50
Refrigerant	Type		-	R410A	R410A	R410A
	Control Method		-	EEV INCLUDED	EEV INCLUDED	EEV INCLUDED
Sound Data	Sound Pressure Level	High / Mid / Low	dB(A)	23 / 21 / 19	24 / 22 / 19	29 / 27 / 24
	Sound Power Level	Cooling		47	48	53
Dimensions	Net Weight		kg	24.0	24.0	24.0
	Shipping Weight		kg	29.0	29.0	29.0
	Net Dimensions (WxHxD)		mm	900 x 199 x 600	900 x 199 x 600	900 x 199 x 600
	Shipping Dimensions (WxHxD)		mm	1150 x 280 x 710	1150 x 280 x 710	1150 x 280 x 710
Panel Size	Panel model		-	-	-	-
	Panel Net Weight		kg	-	-	-
	Shipping Weight		kg	-	-	-
	Net Dimensions (WxHxD)		mm	-	-	-
	Shipping Dimensions (WxHxD)		mm	-	-	-
Additional Accessories	Drain pump	Drain pump	-	Drain Pump Included	Drain Pump Included	Drain Pump Included
		Max. lifting Height	mm	-	-	-
	Air Filter		-	-	-	-

NOTE

- 1) Mode : HP(Heat Pump), HR(Heat Recovery)
 - 2) Nominal Cooling : Indoor temperature 27°CDB / 19°CWB, Outdoor temperature 35°CDB/24°CWB, Refrigerant pipe length 7.5m, Level difference 0m.
 - 3) Nominal Heating : Indoor temperature 20°CDB / 15°CWB, Outdoor temperature 7°CDB / 6°CWB, Refrigerant pipe length 7.5m, Level difference 0m.
 - 4) Sound level was acquired in an anechoic room. Thus actual noise level may be different depending on the installation conditions.
 - 5) These products contain R410A which is fluorinated greenhouse gas.
 - 6) Specifications may be subject to change without prior notice.
- * Heat Exchanger type : Fin & Tube (Fin : Al, Tube : Cu)

1 Specifications

MSP Duct

Type				MSP DUCT	MSP DUCT	MSP DUCT
Model				AM045KNMDEH/EU	AM056KNMDEH/EU	AM071KNMDEH/EU
Power Supply			Φ, #, V, Hz	1,2,220-240,50	1,2,220-240,50	1,2,220-240,50
Mode			-	HP/HR	HP/HR	HP/HR
Performance	Capacity (Nominal)	Cooling	kW	4.50	5.60	7.10
			Btu/h	15,400	19,100	24,200
		Heating	kW	5.00	6.30	8.00
			Btu/h	17,100	21,500	27,300
Power	Power Input (Nominal)	Cooling	W	125.00	130.00	190.00
		Heating		125.00	130.00	190.00
	Current Input (Nominal)	Cooling	A	1.15	1.10	1.25
		Heating		1.15	1.10	1.25
Fan	Type		-	Sirocco Fan	Sirocco Fan	Sirocco Fan
	Motor	Output x n	W	200 x 1	200 x 1	200 x 1
	Air Flow Rate	H/M/L (UL)	CMM	14.00/12.00/10.50	14.50/13.00/11.50	18.50/17.00/15.50
			l/s	233.33/200.00/175.00	241.67/216.67/191.67	308.33/283.33/258.33
	External Static Pressure	Min / Std / Max	mmAq	0.00/4.00/8.00	0.00/4.00/8.00	0.00/4.00/8.00
			Pa	0.00/39.23/78.45	0.00/39.23/78.45	0.00/39.23/78.45
Piping Connections	Liquid Pipe		Φ,mm	6.35	6.35	9.52
			Φ, inch	1/4"	1/4"	3/8"
	Gas Pipe		Φ,mm	12.70	12.70	15.88
			Φ, inch	1/2"	1/2"	5/8"
Drain Pipe		Φ,mm	VP25 (OD 32,ID 25)	VP25 (OD 32,ID 25)	VP25 (OD 32,ID 25)	
Field Wiring	Power Source Wire		mm ²	1.5 ~ 2.5	1.5 ~ 2.5	1.5 ~ 2.5
	Transmission Cable		mm ²	0.75 ~ 1.50	0.75 ~ 1.50	0.75 ~ 1.50
Refrigerant	Type		-	R410A	R410A	R410A
	Control Method		-	EEV INCLUDED	EEV INCLUDED	EEV INCLUDED
Sound Data	Sound Pressure Level	High / Mid / Low	dB(A)	32 / 30 / 28	35 / 33 / 31	39 / 35 / 31
	Sound Power Level	Cooling		54	57	61
Dimensions	Net Weight		kg	28.5	28.5	28.5
	Shipping Weight		kg	33.0	33.0	33.0
	Net Dimensions (WxHxD)		mm	900 x 260 x 480	900 x 260 x 480	900 x 260 x 480
	Shipping Dimensions (WxHxD)		mm	1170 x 340 x 595	1170 x 340 x 595	1170 x 340 x 595
Panel Size	Panel model		-	-	-	-
	Panel Net Weight		kg	-	-	-
	Shipping Weight		kg	-	-	-
	Net Dimensions (WxHxD)		mm	-	-	-
	Shipping Dimensions (WxHxD)		mm	-	-	-
Additional Accessories	Drain pump	Drain pump	-	Drain Pump Included	Drain Pump Included	Drain Pump Included
		Max. lifting Height	mm	-	-	-
	Air Filter		-	-	-	-

NOTE

- 1) Mode : HP(Heat Pump), HR(Heat Recovery)
 - 2) Nominal Cooling : Indoor temperature 27°CDB / 19°CWB, Outdoor temperature 35°CDB/24°CWB, Refrigerant pipe length 7.5m, Level difference 0m.
 - 3) Nominal Heating : Indoor temperature 20°CDB / 15°CWB, Outdoor temperature 7°CDB / 6°CWB, Refrigerant pipe length 7.5m, Level difference 0m.
 - 4) Sound level was acquired in an anechoic room. Thus actual noise level may be different depending on the installation conditions.
 - 5) These products contain R410A which is fluorinated greenhouse gas.
 - 6) Specifications may be subject to change without prior notice.
- * Heat Exchanger type : Fin & Tube (Fin : Al, Tube : Cu)

1 Specifications

MSP Duct

Type				MSP DUCT	MSP DUCT	MSP DUCT
Model				AM090KNMDEH/EU	AM112KNMDEH/EU	AM128KNMDEH/EU
Power Supply			Φ, #, V, Hz	1,2,220-240,50	1,2,220-240,50	1,2,220-240,50
Mode			-	HP/HR	HP/HR	HP/HR
Performance	Capacity (Nominal)	Cooling	kW	9.00	11.20	12.80
			Btu/h	30,700	38,200	43,700
		Heating	kW	10.00	12.50	13.80
			Btu/h	34,100	42,700	47,100
Power	Power Input (Nominal)	Cooling	W	240.00	260.00	370.00
		Heating		240.00	260.00	370.00
	Current Input (Nominal)	Cooling	A	1.30	1.17	1.67
		Heating		1.30	1.17	1.67
Fan	Type		-	Sirocco Fan	Sirocco Fan	Sirocco Fan
	Motor	Output x n	W	200 x 1	130 x 1	218 x 1
	Air Flow Rate	H/M/L (UL)	CMM	19.50/18.00/16.50	27.00/25.00/23.00	32.00/30.00/28.00
			l/s	325.00/300.00/275.00	450.00/416.67/383.33	533.33/500.00/466.67
	External Static Pressure	Min / Std / Max	mmAq	4.00/6.00/8.00	4.00/8.00/12.00	4.00/8.00/14.00
			Pa	39.23/58.84/78.45	39.23/78.45/117.68	39.23/78.45/137.29
Piping Connections	Liquid Pipe		Φ,mm	9.52	9.52	9.52
			Φ, inch	3/8"	3/8"	3/8"
	Gas Pipe		Φ,mm	15.88	15.88	15.88
			Φ, inch	5/8"	5/8"	5/8"
Drain Pipe		Φ,mm	VP25 (OD 32,ID 25)	VP25 (OD 32,ID 25)	VP25 (OD 32,ID 25)	
Field Wiring	Power Source Wire		mm ²	1.5 ~ 2.5	1.5 ~ 2.5	1.5 ~ 2.5
	Transmission Cable		mm ²	0.75 ~ 1.50	0.75 ~ 1.50	0.75 ~ 1.50
Refrigerant	Type		-	R410A	R410A	R410A
	Control Method		-	EEV INCLUDED	EEV INCLUDED	EEV INCLUDED
Sound Data	Sound Pressure Level	High / Mid / Low	dB(A)	40 / 37 / 34	41 / 40 / 38	41 / 40 / 38
	Sound Power Level	Cooling		63	66	66
Dimensions	Net Weight		kg	32.5	36.0	48.5
	Shipping Weight		kg	37.5	41.0	57.0
	Net Dimensions (WxHxD)		mm	1150 x 260 x 480	1150 x 320 x 480	1200 x 360 x 650
	Shipping Dimensions (WxHxD)		mm	1420 x 340 x 595	1420 x 400 x 595	1480 x 420 x 790
Panel Size	Panel model		-	-	-	-
	Panel Net Weight		kg	-	-	-
	Shipping Weight		kg	-	-	-
	Net Dimensions (WxHxD)		mm	-	-	-
	Shipping Dimensions (WxHxD)		mm	-	-	-
Additional Accessories	Drain pump	Drain pump	-	Drain Pump Included	Drain Pump Included	Drain Pump Included
		Max. lifting Height	mm	-	-	-
	Air Filter		-	-	-	-

NOTE

- 1) Mode : HP(Heat Pump), HR(Heat Recovery)
 - 2) Nominal Cooling : Indoor temperature 27°CDB / 19°CWB, Outdoor temperature 35°CDB/24°CWB, Refrigerant pipe length 7.5m, Level difference 0m.
 - 3) Nominal Heating : Indoor temperature 20°CDB / 15°CWB, Outdoor temperature 7°CDB / 6°CWB, Refrigerant pipe length 7.5m, Level difference 0m.
 - 4) Sound level was acquired in an anechoic room. Thus actual noise level may be different depending on the installation conditions.
 - 5) These products contain R410A which is fluorinated greenhouse gas.
 - 6) Specifications may be subject to change without prior notice.
- * Heat Exchanger type : Fin & Tube (Fin : Al, Tube : Cu)

1 Specifications

MSP Duct

Type				MSP DUCT	MSP DUCT
Model				AM140KNMDEH/EU	AM160KNMDEH1EU
Power Supply			Φ , #, V, Hz	1,2,220-240,50	1,2,220-240,50
Mode			-	HP/HR	HP/HR
Performance	Capacity (Nominal)	Cooling	kW	14.00	16.00
			Btu/h	47,800	54,600
		Heating	kW	16.00	18.00
			Btu/h	54,600	61,400
Power	Power Input (Nominal)	Cooling	W	410.00	485.00
		Heating		410.00	485.00
	Current Input (Nominal)	Cooling	A	1.86	2.24
		Heating		1.86	2.24
Fan	Type		-	Sirocco Fan	Sirocco Fan
	Motor	Output x n	W	218 x 1	370 x 1
	Air Flow Rate	H/M/L (UL)	CMM	37.00/34.00/31.00	43.00/38.00/30.50
			l/s	616.67/566.67/516.67	716.67/633.33/508.33
	External Static Pressure	Min / Std / Max	mmAq	4.00/8.00/14.00	4.00/8.00/14.00
			Pa	39.23/78.45/137.29	39.23/78.45/137.29
Piping Connections	Liquid Pipe		Φ ,mm	9.52	9.52
			Φ , inch	3/8"	3/8"
	Gas Pipe		Φ ,mm	15.88	15.88
			Φ , inch	5/8"	5/8"
Drain Pipe		Φ ,mm	VP25 (OD 32,ID 25)	VP25 (OD 32,ID 25)	
Field Wiring	Power Source Wire		mm ²	1.5 ~ 2.5	1.5 ~ 2.5
	Transmission Cable		mm ²	0.75 ~ 1.50	0.75 ~ 1.50
Refrigerant	Type		-	R410A	R410A
	Control Method		-	EEV INCLUDED	EEV INCLUDED
Sound Data	Sound Pressure Level	High / Mid / Low	dB(A)	42 / 39 / 36	43 / 40 / 36
	Sound Power Level	Cooling		68	69
Dimensions	Net Weight		kg	48.5	50.5
	Shipping Weight		kg	57.0	59.0
	Net Dimensions (WxHxD)		mm	1200 x 360 x 650	1200 x 360 x 650
	Shipping Dimensions (WxHxD)		mm	1480 x 420 x 790	1480 x 420 x 790
Panel Size	Panel model		-	-	-
	Panel Net Weight		kg	-	-
	Shipping Weight		kg	-	-
	Net Dimensions (WxHxD)		mm	-	-
	Shipping Dimensions (WxHxD)		mm	-	-
Additional Accessories	Drain pump	Drain pump	-	Drain Pump Included	Drain Pump Included
		Max. lifting Height	mm	-	-
	Air Filter		-	-	-

NOTE

- 1) Mode : HP(Heat Pump), HR(Heat Recovery)
 - 2) Nominal Cooling : Indoor temperature 27°CDB / 19°CWB, Outdoor temperature 35°CDB/24°CWB, Refrigerant pipe length 7.5m, Level difference 0m.
 - 3) Nominal Heating : Indoor temperature 20°CDB / 15°CWB, Outdoor temperature 7°CDB / 6°CWB, Refrigerant pipe length 7.5m, Level difference 0m.
 - 4) Sound level was acquired in an anechoic room. Thus actual noise level may be different depending on the installation conditions.
 - 5) These products contain R410A which is fluorinated greenhouse gas.
 - 6) Specifications may be subject to change without prior notice.
- * Heat Exchanger type : Fin & Tube (Fin : Al, Tube : Cu)

2 Capacity Table

MSP Duct

Cooling

TC : Total Capacity(kW), SHC : Sensible Heat Capacity(kW)

Capacity Index	Outdoor Air Temp. (°C,DB)	Indoor temperature													
		20(°C,DB)		23(°C,DB)		26(°C,DB)		27(°C,DB)		28(°C,DB)		30(°C,DB)		32(°C,DB)	
		14(°C,WB)		16(°C,WB)		18(°C,WB)		19(°C,WB)		20(°C,WB)		22(°C,WB)		24(°C,WB)	
		TC	SHC	TC	SHC	TC	SHC	TC	SHC	TC	SHC	TC	SHC	TC	SHC
022	10	1.5	1.2	1.8	1.4	2.1	1.6	2.2	1.6	2.3	1.6	2.5	1.7	2.6	1.5
	12	1.5	1.2	1.8	1.4	2.1	1.6	2.2	1.6	2.3	1.6	2.5	1.7	2.6	1.5
	14	1.5	1.2	1.8	1.4	2.1	1.6	2.2	1.6	2.3	1.6	2.5	1.7	2.6	1.5
	16	1.5	1.2	1.8	1.4	2.1	1.6	2.2	1.6	2.3	1.6	2.4	1.6	2.6	1.5
	18	1.5	1.2	1.8	1.4	2.1	1.6	2.2	1.6	2.3	1.6	2.4	1.6	2.6	1.5
	20	1.5	1.2	1.8	1.4	2.1	1.6	2.2	1.6	2.3	1.6	2.4	1.6	2.6	1.5
	21	1.5	1.2	1.8	1.4	2.1	1.6	2.2	1.6	2.3	1.6	2.4	1.6	2.6	1.5
	23	1.5	1.2	1.8	1.4	2.1	1.6	2.2	1.6	2.3	1.6	2.4	1.6	2.6	1.5
	25	1.5	1.2	1.8	1.4	2.1	1.6	2.2	1.6	2.3	1.6	2.4	1.6	2.6	1.5
	27	1.5	1.2	1.8	1.4	2.1	1.6	2.2	1.6	2.3	1.6	2.4	1.6	2.6	1.5
	29	1.5	1.2	1.8	1.4	2.1	1.6	2.2	1.6	2.3	1.6	2.4	1.6	2.6	1.5
	31	1.5	1.2	1.8	1.4	2.1	1.6	2.2	1.6	2.3	1.6	2.4	1.6	2.6	1.5
	33	1.5	1.2	1.8	1.4	2.1	1.6	2.2	1.6	2.3	1.6	2.4	1.6	2.6	1.5
	35	1.5	1.2	1.8	1.4	2.1	1.6	2.2	1.6	2.3	1.6	2.4	1.6	2.6	1.5
	37	1.5	1.2	1.8	1.4	2.1	1.6	2.2	1.6	2.3	1.6	2.4	1.6	2.6	1.5
39	1.5	1.2	1.8	1.4	2.1	1.6	2.2	1.6	2.3	1.6	2.4	1.6	2.5	1.4	
42	1.5	1.2	1.8	1.4	2.1	1.6	2.2	1.6	2.3	1.6	2.4	1.6	2.4	1.4	
44	1.5	1.2	1.8	1.4	2.0	1.5	2.1	1.5	2.2	1.5	2.3	1.5	2.4	1.3	
46	1.5	1.2	1.8	1.4	2.0	1.5	2.0	1.5	2.1	1.5	2.2	1.5	2.3	1.3	
48	1.5	1.2	1.8	1.4	2.0	1.5	2.0	1.4	2.1	1.5	2.1	1.4	2.2	1.2	
028	10	1.9	1.6	2.3	1.8	2.6	1.9	2.8	2.0	2.9	2.0	3.1	2.0	3.4	2.0
	12	1.9	1.6	2.3	1.8	2.6	1.9	2.8	2.0	2.9	2.0	3.1	2.0	3.3	1.9
	14	1.9	1.6	2.3	1.8	2.6	1.9	2.8	2.0	2.9	2.0	3.1	2.0	3.3	1.9
	16	1.9	1.6	2.3	1.8	2.6	1.9	2.8	2.0	2.9	2.0	3.1	2.0	3.3	1.9
	18	1.9	1.6	2.3	1.8	2.6	1.9	2.8	2.0	2.9	2.0	3.1	2.0	3.3	1.9
	20	1.9	1.6	2.3	1.8	2.6	1.9	2.8	2.0	2.9	2.0	3.1	2.0	3.3	1.9
	21	1.9	1.6	2.3	1.8	2.6	1.9	2.8	2.0	2.9	2.0	3.1	2.0	3.3	1.9
	23	1.9	1.6	2.3	1.8	2.6	1.9	2.8	2.0	2.9	2.0	3.1	2.0	3.3	1.9
	25	1.9	1.6	2.3	1.8	2.6	1.9	2.8	2.0	2.9	2.0	3.1	2.0	3.3	1.9
	27	1.9	1.6	2.3	1.8	2.6	1.9	2.8	2.0	2.9	2.0	3.1	2.0	3.3	1.9
	29	1.9	1.6	2.3	1.8	2.6	1.9	2.8	2.0	2.9	2.0	3.1	2.0	3.3	1.9
	31	1.9	1.6	2.3	1.8	2.6	1.9	2.8	2.0	2.9	2.0	3.1	2.0	3.3	1.9
	33	1.9	1.6	2.3	1.8	2.6	1.9	2.8	2.0	2.9	2.0	3.1	2.0	3.3	1.9
	35	1.9	1.6	2.3	1.8	2.6	1.9	2.8	2.0	2.9	2.0	3.1	2.0	3.3	1.9
	37	1.9	1.6	2.3	1.8	2.6	1.9	2.8	2.0	2.9	2.0	3.1	2.0	3.3	1.9
39	1.9	1.6	2.3	1.8	2.6	1.9	2.8	2.0	2.9	2.0	3.0	1.9	3.2	1.8	
42	1.9	1.6	2.3	1.8	2.6	1.9	2.8	2.0	2.9	2.0	2.9	1.9	3.1	1.8	
44	1.9	1.6	2.3	1.8	2.5	1.8	2.7	1.9	2.8	1.9	2.8	1.8	3.0	1.7	
46	1.9	1.6	2.3	1.8	2.5	1.8	2.6	1.8	2.7	1.9	2.7	1.7	2.9	1.6	
48	1.9	1.6	2.2	1.8	2.4	1.8	2.5	1.8	2.6	1.8	2.7	1.7	2.8	1.6	
036	10	2.5	2.0	2.9	2.3	3.4	2.5	3.6	2.6	3.7	2.6	4.0	2.6	4.3	2.5
	12	2.5	2.0	2.9	2.3	3.4	2.5	3.6	2.6	3.7	2.6	4.0	2.6	4.3	2.5
	14	2.5	2.0	2.9	2.3	3.4	2.5	3.6	2.6	3.7	2.6	4.0	2.6	4.3	2.5
	16	2.5	2.0	2.9	2.3	3.4	2.5	3.6	2.6	3.7	2.6	4.0	2.6	4.3	2.5
	18	2.5	2.0	2.9	2.3	3.4	2.5	3.6	2.6	3.7	2.6	4.0	2.6	4.2	2.4
	20	2.5	2.0	2.9	2.3	3.4	2.5	3.6	2.6	3.7	2.6	4.0	2.6	4.2	2.4
	21	2.5	2.0	2.9	2.3	3.4	2.5	3.6	2.6	3.7	2.6	4.0	2.6	4.2	2.4
	23	2.5	2.0	2.9	2.3	3.4	2.5	3.6	2.6	3.7	2.6	4.0	2.6	4.2	2.4
	25	2.5	2.0	2.9	2.3	3.4	2.5	3.6	2.6	3.7	2.6	4.0	2.6	4.2	2.4
	27	2.5	2.0	2.9	2.3	3.4	2.5	3.6	2.6	3.7	2.6	4.0	2.6	4.2	2.4
	29	2.5	2.0	2.9	2.3	3.4	2.5	3.6	2.6	3.7	2.6	4.0	2.6	4.2	2.4
	31	2.5	2.0	2.9	2.3	3.4	2.5	3.6	2.6	3.7	2.6	4.0	2.6	4.2	2.4
	33	2.5	2.0	2.9	2.3	3.4	2.5	3.6	2.6	3.7	2.6	4.0	2.6	4.2	2.4
	35	2.5	2.0	2.9	2.3	3.4	2.5	3.6	2.6	3.7	2.6	4.0	2.6	4.2	2.4
	37	2.5	2.0	2.9	2.3	3.4	2.5	3.6	2.6	3.7	2.6	3.9	2.5	4.2	2.4
39	2.5	2.0	2.9	2.3	3.4	2.5	3.6	2.6	3.7	2.6	3.9	2.5	4.1	2.3	
42	2.5	2.0	2.9	2.3	3.4	2.5	3.6	2.6	3.7	2.6	3.8	2.5	4.0	2.2	
44	2.5	2.0	2.9	2.3	3.3	2.4	3.4	2.5	3.6	2.5	3.7	2.4	3.9	2.2	
46	2.5	2.0	2.9	2.3	3.2	2.4	3.3	2.4	3.4	2.4	3.6	2.3	3.8	2.1	
48	2.5	2.0	2.8	2.2	3.2	2.3	3.2	2.3	3.4	2.4	3.5	2.2	3.6	2.0	

2 Capacity Table

MSP Duct

Cooling

TC : Total Capacity(kW), SHC : Sensible Heat Capacity(kW)

Capacity Index	Outdoor Air Temp. (°C,DB)	Indoor temperature													
		20(°C,DB)		23(°C,DB)		26(°C,DB)		27(°C,DB)		28(°C,DB)		30(°C,DB)		32(°C,DB)	
		14(°C,WB)		16(°C,WB)		18(°C,WB)		19(°C,WB)		20(°C,WB)		22(°C,WB)		24(°C,WB)	
		TC	SHC	TC	SHC	TC	SHC	TC	SHC	TC	SHC	TC	SHC	TC	SHC
045	10	3.1	2.7	3.7	3.1	4.2	3.2	4.5	3.3	4.7	3.3	5.0	3.3	5.4	3.4
	12	3.1	2.7	3.7	3.1	4.2	3.2	4.5	3.3	4.7	3.3	5.0	3.3	5.4	3.4
	14	3.1	2.7	3.7	3.1	4.2	3.2	4.5	3.3	4.7	3.3	5.0	3.3	5.4	3.4
	16	3.1	2.7	3.7	3.1	4.2	3.2	4.5	3.3	4.7	3.3	5.0	3.3	5.3	3.1
	18	3.1	2.7	3.7	3.1	4.2	3.2	4.5	3.3	4.7	3.3	5.0	3.3	5.3	3.1
	20	3.1	2.7	3.7	3.1	4.2	3.2	4.5	3.3	4.7	3.3	5.0	3.3	5.3	3.1
	21	3.1	2.7	3.7	3.1	4.2	3.2	4.5	3.3	4.7	3.3	5.0	3.3	5.3	3.1
	23	3.1	2.7	3.7	3.1	4.2	3.2	4.5	3.3	4.7	3.3	5.0	3.3	5.3	3.1
	25	3.1	2.7	3.7	3.1	4.2	3.2	4.5	3.3	4.7	3.3	5.0	3.3	5.3	3.1
	27	3.1	2.7	3.7	3.1	4.2	3.2	4.5	3.3	4.7	3.3	5.0	3.3	5.3	3.1
	29	3.1	2.7	3.7	3.1	4.2	3.2	4.5	3.3	4.7	3.3	5.0	3.3	5.3	3.1
	31	3.1	2.7	3.7	3.1	4.2	3.2	4.5	3.3	4.7	3.3	5.0	3.3	5.3	3.1
	33	3.1	2.7	3.7	3.1	4.2	3.2	4.5	3.3	4.7	3.3	5.0	3.3	5.3	3.1
	35	3.1	2.7	3.7	3.1	4.2	3.2	4.5	3.3	4.7	3.3	5.0	3.3	5.3	3.1
	37	3.1	2.7	3.7	3.1	4.2	3.2	4.5	3.3	4.6	3.2	4.9	3.2	5.2	3.1
39	3.1	2.7	3.7	3.1	4.2	3.2	4.5	3.3	4.6	3.2	4.9	3.2	5.1	3.0	
42	3.1	2.7	3.7	3.1	4.2	3.2	4.4	3.3	4.5	3.2	4.8	3.1	5.0	2.9	
44	3.1	2.7	3.7	3.1	4.1	3.1	4.3	3.2	4.4	3.1	4.6	3.0	4.8	2.8	
46	3.1	2.7	3.7	3.1	4.0	3.0	4.2	3.1	4.3	3.0	4.5	2.9	4.7	2.7	
48	3.1	2.6	3.6	3.0	3.9	3.0	4.0	3.0	4.2	2.9	4.3	2.8	4.5	2.6	
056	10	3.9	3.3	4.6	3.8	5.3	4.0	5.6	4.2	5.8	4.2	6.3	4.3	6.7	4.1
	12	3.9	3.3	4.6	3.8	5.3	4.0	5.6	4.2	5.8	4.2	6.3	4.3	6.7	4.1
	14	3.9	3.3	4.6	3.8	5.3	4.0	5.6	4.2	5.8	4.2	6.2	4.2	6.7	4.1
	16	3.9	3.3	4.6	3.8	5.3	4.0	5.6	4.2	5.8	4.2	6.2	4.2	6.6	4.0
	18	3.9	3.3	4.6	3.8	5.3	4.0	5.6	4.2	5.8	4.2	6.2	4.2	6.6	4.0
	20	3.9	3.3	4.6	3.8	5.3	4.0	5.6	4.2	5.8	4.2	6.2	4.2	6.6	4.0
	21	3.9	3.3	4.6	3.8	5.3	4.0	5.6	4.2	5.8	4.2	6.2	4.2	6.6	4.0
	23	3.9	3.3	4.6	3.8	5.3	4.0	5.6	4.2	5.8	4.2	6.2	4.2	6.6	4.0
	25	3.9	3.3	4.6	3.8	5.3	4.0	5.6	4.2	5.8	4.2	6.2	4.2	6.6	4.0
	27	3.9	3.3	4.6	3.8	5.3	4.0	5.6	4.2	5.8	4.2	6.2	4.2	6.6	4.0
	29	3.9	3.3	4.6	3.8	5.3	4.0	5.6	4.2	5.8	4.2	6.2	4.2	6.6	4.0
	31	3.9	3.3	4.6	3.8	5.3	4.0	5.6	4.2	5.8	4.2	6.2	4.2	6.6	4.0
	33	3.9	3.3	4.6	3.8	5.3	4.0	5.6	4.2	5.8	4.2	6.2	4.2	6.6	4.0
	35	3.9	3.3	4.6	3.8	5.3	4.0	5.6	4.2	5.8	4.2	6.2	4.2	6.6	4.0
	37	3.9	3.3	4.6	3.8	5.3	4.0	5.6	4.2	5.8	4.2	6.1	4.1	6.5	3.9
39	3.9	3.3	4.6	3.8	5.3	4.0	5.6	4.2	5.8	4.2	6.1	4.1	6.4	3.8	
42	3.9	3.3	4.6	3.8	5.3	4.0	5.5	4.1	5.7	4.2	6.0	4.0	6.2	3.7	
44	3.9	3.3	4.6	3.8	5.1	3.9	5.3	4.0	5.6	4.0	5.8	3.9	6.0	3.6	
46	3.9	3.3	4.6	3.7	5.0	3.8	5.2	3.9	5.4	3.9	5.6	3.7	5.9	3.5	
48	3.9	3.2	4.5	3.7	5.0	3.7	5.0	3.8	5.3	3.8	5.4	3.6	5.7	3.3	
071	10	4.9	4.3	5.8	5.0	6.7	5.2	7.1	5.4	7.4	5.6	8.0	5.7	8.5	5.4
	12	4.9	4.3	5.8	5.0	6.7	5.2	7.1	5.4	7.4	5.6	7.9	5.6	8.5	5.4
	14	4.9	4.3	5.8	5.0	6.7	5.2	7.1	5.4	7.4	5.6	7.9	5.6	8.5	5.4
	16	4.9	4.3	5.8	5.0	6.7	5.2	7.1	5.4	7.4	5.6	7.9	5.6	8.4	5.3
	18	4.9	4.3	5.8	5.0	6.7	5.2	7.1	5.4	7.4	5.6	7.9	5.6	8.4	5.3
	20	4.9	4.3	5.8	5.0	6.7	5.2	7.1	5.4	7.4	5.6	7.9	5.6	8.4	5.3
	21	4.9	4.3	5.8	5.0	6.7	5.2	7.1	5.4	7.4	5.6	7.9	5.6	8.4	5.3
	23	4.9	4.3	5.8	5.0	6.7	5.2	7.1	5.4	7.4	5.6	7.9	5.6	8.4	5.3
	25	4.9	4.3	5.8	5.0	6.7	5.2	7.1	5.4	7.4	5.6	7.9	5.6	8.4	5.3
	27	4.9	4.3	5.8	5.0	6.7	5.2	7.1	5.4	7.4	5.6	7.9	5.6	8.4	5.3
	29	4.9	4.3	5.8	5.0	6.7	5.2	7.1	5.4	7.4	5.6	7.9	5.6	8.4	5.3
	31	4.9	4.3	5.8	5.0	6.7	5.2	7.1	5.4	7.4	5.6	7.9	5.6	8.4	5.3
	33	4.9	4.3	5.8	5.0	6.7	5.2	7.1	5.4	7.4	5.6	7.9	5.6	8.4	5.3
	35	4.9	4.3	5.8	5.0	6.7	5.2	7.1	5.4	7.4	5.6	7.9	5.6	8.4	5.3
	37	4.9	4.3	5.8	5.0	6.7	5.2	7.1	5.4	7.3	5.5	7.8	5.5	8.2	5.2
39	4.9	4.3	5.8	5.0	6.7	5.2	7.1	5.4	7.3	5.5	7.7	5.4	8.1	5.1	
42	4.9	4.3	5.8	5.0	6.7	5.2	7.0	5.3	7.2	5.4	7.6	5.3	7.9	5.0	
44	4.9	4.3	5.8	5.0	6.5	5.0	6.8	5.2	7.0	5.3	7.3	5.1	7.6	4.8	
46	4.9	4.3	5.7	5.0	6.4	4.9	6.6	5.0	6.8	5.1	7.0	4.9	7.4	4.7	
48	4.8	4.2	5.7	4.9	6.3	4.9	6.4	4.9	6.7	5.0	6.8	4.8	7.2	4.5	

2 Capacity Table

MSP Duct

Cooling

TC : Total Capacity(kW), SHC : Sensible Heat Capacity(kW)

Capacity Index	Outdoor Air Temp. (°C,DB)	Indoor temperature													
		20(°C,DB)		23(°C,DB)		26(°C,DB)		27(°C,DB)		28(°C,DB)		30(°C,DB)		32(°C,DB)	
		14(°C,WB)		16(°C,WB)		18(°C,WB)		19(°C,WB)		20(°C,WB)		22(°C,WB)		24(°C,WB)	
		TC	SHC	TC	SHC	TC	SHC	TC	SHC	TC	SHC	TC	SHC	TC	SHC
090	10	6.2	5.7	7.3	6.5	8.4	6.9	9.0	7.1	9.4	7.3	10.1	7.3	10.8	7.3
	12	6.2	5.7	7.3	6.5	8.4	6.9	9.0	7.1	9.4	7.3	10.1	7.3	10.8	7.3
	14	6.2	5.7	7.3	6.5	8.4	6.9	9.0	7.1	9.3	7.2	10.0	7.2	10.7	7.1
	16	6.2	5.7	7.3	6.5	8.4	6.9	9.0	7.1	9.3	7.2	10.0	7.2	10.7	7.1
	18	6.2	5.7	7.3	6.5	8.4	6.9	9.0	7.1	9.3	7.2	10.0	7.2	10.6	7.0
	20	6.2	5.7	7.3	6.5	8.4	6.9	9.0	7.1	9.3	7.2	10.0	7.2	10.6	7.0
	21	6.2	5.7	7.3	6.5	8.4	6.9	9.0	7.1	9.3	7.2	10.0	7.2	10.6	7.0
	23	6.2	5.7	7.3	6.5	8.4	6.9	9.0	7.1	9.3	7.2	10.0	7.2	10.6	7.0
	25	6.2	5.7	7.3	6.5	8.4	6.9	9.0	7.1	9.3	7.2	10.0	7.2	10.6	7.0
	27	6.2	5.7	7.3	6.5	8.4	6.9	9.0	7.1	9.3	7.2	10.0	7.2	10.6	7.0
	29	6.2	5.7	7.3	6.5	8.4	6.9	9.0	7.1	9.3	7.2	10.0	7.2	10.6	7.0
	31	6.2	5.7	7.3	6.5	8.4	6.9	9.0	7.1	9.3	7.2	10.0	7.2	10.6	7.0
	33	6.2	5.7	7.3	6.5	8.4	6.9	9.0	7.1	9.3	7.2	10.0	7.2	10.6	7.0
	35	6.2	5.7	7.3	6.5	8.4	6.9	9.0	7.1	9.3	7.2	10.0	7.2	10.6	7.0
	37	6.2	5.7	7.3	6.5	8.4	6.9	9.0	7.1	9.3	7.2	9.9	7.1	10.4	6.9
	39	6.2	5.7	7.3	6.5	8.4	6.9	9.0	7.1	9.2	7.1	9.7	7.0	10.2	6.8
42	6.2	5.7	7.3	6.5	8.3	6.8	8.9	7.0	9.1	7.0	9.5	6.9	9.9	6.6	
44	6.2	5.7	7.3	6.5	8.1	6.7	8.6	6.8	8.8	6.8	9.2	6.6	9.6	6.4	
46	6.2	5.7	7.2	6.4	8.0	6.6	8.3	6.6	8.6	6.6	8.9	6.4	9.3	6.2	
48	6.1	5.6	7.1	6.3	7.8	6.4	8.1	6.4	8.4	6.5	8.6	6.2	9.0	6.0	
112	10	7.7	6.8	9.1	7.7	10.5	8.2	11.2	8.6	11.6	8.8	12.5	8.9	13.4	8.6
	12	7.7	6.8	9.1	7.7	10.5	8.2	11.2	8.6	11.6	8.8	12.5	8.9	13.4	8.6
	14	7.7	6.8	9.1	7.7	10.5	8.2	11.2	8.6	11.6	8.8	12.5	8.9	13.4	8.6
	16	7.7	6.8	9.1	7.7	10.5	8.2	11.2	8.6	11.6	8.8	12.5	8.9	13.3	8.5
	18	7.7	6.8	9.1	7.7	10.5	8.2	11.2	8.6	11.6	8.8	12.5	8.9	13.3	8.5
	20	7.7	6.8	9.1	7.7	10.5	8.2	11.2	8.6	11.6	8.8	12.4	8.8	13.2	8.5
	21	7.7	6.8	9.1	7.7	10.5	8.2	11.2	8.6	11.6	8.8	12.4	8.8	13.2	8.5
	23	7.7	6.8	9.1	7.7	10.5	8.2	11.2	8.6	11.6	8.8	12.4	8.8	13.2	8.5
	25	7.7	6.8	9.1	7.7	10.5	8.2	11.2	8.6	11.6	8.8	12.4	8.8	13.2	8.5
	27	7.7	6.8	9.1	7.7	10.5	8.2	11.2	8.6	11.6	8.8	12.4	8.8	13.2	8.5
	29	7.7	6.8	9.1	7.7	10.5	8.2	11.2	8.6	11.6	8.8	12.4	8.8	13.2	8.5
	31	7.7	6.8	9.1	7.7	10.5	8.2	11.2	8.6	11.6	8.8	12.4	8.8	13.2	8.5
	33	7.7	6.8	9.1	7.7	10.5	8.2	11.2	8.6	11.6	8.8	12.4	8.8	13.2	8.5
	35	7.7	6.8	9.1	7.7	10.5	8.2	11.2	8.6	11.6	8.8	12.4	8.7	13.2	8.5
	37	7.7	6.8	9.1	7.7	10.5	8.2	11.2	8.6	11.6	8.8	12.4	8.9	13.2	8.5
	39	7.7	6.8	9.1	7.7	10.5	8.2	11.2	8.6	11.6	8.8	12.3	8.8	13.0	8.4
42	7.7	6.8	9.1	7.7	10.4	8.1	11.1	8.5	11.5	8.7	12.1	8.6	12.7	8.2	
44	7.7	6.8	9.1	7.7	10.1	7.9	10.7	8.2	11.1	8.4	11.6	8.3	12.2	7.9	
46	7.7	6.8	9.0	7.6	10.0	7.8	10.4	8.0	10.8	8.2	11.2	8.0	11.9	7.7	
48	7.6	6.7	8.9	7.5	9.8	7.7	10.1	7.7	10.6	8.0	10.9	7.8	11.5	7.4	
128	10	8.8	7.8	10.4	8.9	12.0	9.5	12.8	9.9	13.3	9.9	14.3	10.0	15.4	9.9
	12	8.8	7.8	10.4	8.9	12.0	9.5	12.8	9.9	13.3	9.9	14.3	10.0	15.3	9.8
	14	8.8	7.8	10.4	8.9	12.0	9.5	12.8	9.9	13.3	9.9	14.3	10.0	15.3	9.8
	16	8.8	7.8	10.4	8.9	12.0	9.5	12.8	9.9	13.3	9.9	14.2	9.9	15.2	9.8
	18	8.8	7.8	10.4	8.9	12.0	9.5	12.8	9.9	13.3	9.9	14.2	9.9	15.1	9.7
	20	8.8	7.8	10.4	8.9	12.0	9.5	12.8	9.9	13.3	9.9	14.2	9.9	15.1	9.7
	21	8.8	7.8	10.4	8.9	12.0	9.5	12.8	9.9	13.3	9.9	14.2	9.9	15.1	9.7
	23	8.8	7.8	10.4	8.9	12.0	9.5	12.8	9.9	13.3	9.9	14.2	9.9	15.1	9.7
	25	8.8	7.8	10.4	8.9	12.0	9.5	12.8	9.9	13.3	9.9	14.2	9.9	15.1	9.7
	27	8.8	7.8	10.4	8.9	12.0	9.5	12.8	9.9	13.3	9.9	14.2	9.9	15.1	9.7
	29	8.8	7.8	10.4	8.9	12.0	9.5	12.8	9.9	13.3	9.9	14.2	9.9	15.1	9.7
	31	8.8	7.8	10.4	8.9	12.0	9.5	12.8	9.9	13.3	9.9	14.2	9.9	15.1	9.7
	33	8.8	7.8	10.4	8.9	12.0	9.5	12.8	9.9	13.3	9.9	14.2	9.9	15.1	9.7
	35	8.8	7.8	10.4	8.9	12.0	9.5	12.8	9.9	13.3	9.9	14.2	9.9	15.1	9.7
	37	8.8	7.8	10.4	8.9	12.0	9.5	12.8	9.9	13.2	9.9	14.0	9.8	14.9	9.6
	39	8.8	7.8	10.4	8.9	12.0	9.5	12.8	9.9	13.1	9.8	13.8	9.6	14.5	9.4
42	8.8	7.8	10.4	8.9	11.9	9.4	12.6	9.8	12.9	9.7	13.6	9.4	14.1	9.2	
44	8.8	7.8	10.4	8.9	11.6	9.2	12.2	9.5	12.6	9.4	13.0	9.1	13.6	8.8	
46	8.8	7.8	10.3	8.8	11.4	9.0	11.8	9.2	12.2	9.1	12.6	8.8	13.3	8.6	
48	8.7	7.7	10.2	8.7	11.2	8.9	11.5	8.9	12.0	8.9	12.2	8.5	12.8	8.3	

2 Capacity Table

MSP Duct

Cooling

TC : Total Capacity(kW), SHC : Sensible Heat Capacity(kW)

Capacity Index	Outdoor Air Temp. (°C,DB)	Indoor temperature													
		20(°C,DB)		23(°C,DB)		26(°C,DB)		27(°C,DB)		28(°C,DB)		30(°C,DB)		32(°C,DB)	
		14(°C,WB)		16(°C,WB)		18(°C,WB)		19(°C,WB)		20(°C,WB)		22(°C,WB)		24(°C,WB)	
		TC	SHC	TC	SHC	TC	SHC	TC	SHC	TC	SHC	TC	SHC	TC	SHC
140	10	9.7	8.6	11.4	9.7	13.1	10.5	14.0	10.8	14.6	10.9	15.7	11.0	16.8	10.9
	12	9.7	8.6	11.4	9.7	13.1	10.5	14.0	10.8	14.5	10.8	15.6	10.9	16.7	10.8
	14	9.7	8.6	11.4	9.7	13.1	10.5	14.0	10.8	14.5	10.8	15.6	10.9	16.7	10.8
	16	9.7	8.6	11.4	9.7	13.1	10.5	14.0	10.8	14.5	10.8	15.6	10.9	16.6	10.7
	18	9.7	8.6	11.4	9.7	13.1	10.5	14.0	10.8	14.5	10.8	15.5	10.8	16.6	10.7
	20	9.7	8.6	11.4	9.7	13.1	10.5	14.0	10.8	14.5	10.8	15.5	10.8	16.5	10.6
	21	9.7	8.6	11.4	9.7	13.1	10.5	14.0	10.8	14.5	10.8	15.5	10.8	16.5	10.6
	23	9.7	8.6	11.4	9.7	13.1	10.5	14.0	10.8	14.5	10.8	15.5	10.8	16.5	10.6
	25	9.7	8.6	11.4	9.7	13.1	10.5	14.0	10.8	14.5	10.8	15.5	10.8	16.5	10.6
	27	9.7	8.6	11.4	9.7	13.1	10.5	14.0	10.8	14.5	10.8	15.5	10.8	16.5	10.6
	29	9.7	8.6	11.4	9.7	13.1	10.5	14.0	10.8	14.5	10.8	15.5	10.8	16.5	10.6
	31	9.7	8.6	11.4	9.7	13.1	10.5	14.0	10.8	14.5	10.8	15.5	10.8	16.5	10.6
	33	9.7	8.6	11.4	9.7	13.1	10.5	14.0	10.8	14.5	10.8	15.5	10.8	16.5	10.6
	35	9.7	8.6	11.4	9.7	13.1	10.5	14.0	10.8	14.5	10.8	15.5	10.8	16.5	10.6
	37	9.7	8.6	11.4	9.7	13.1	10.5	14.0	10.8	14.5	10.8	15.4	10.7	16.3	10.5
	39	9.7	8.6	11.4	9.7	13.1	10.5	14.0	10.8	14.4	10.7	15.1	10.5	15.9	10.3
42	9.7	8.6	11.4	9.7	13.0	10.4	13.8	10.7	14.2	10.6	14.8	10.3	15.5	10.0	
44	9.7	8.6	11.4	9.7	12.7	10.1	13.4	10.3	13.8	10.3	14.2	9.9	15.0	9.7	
46	9.7	8.6	11.3	9.6	12.4	10.0	12.9	10.0	13.4	10.0	13.8	9.6	14.6	9.4	
48	9.6	8.5	11.1	9.5	12.2	9.8	12.6	9.7	13.1	9.8	13.4	9.3	14.1	9.1	
160	10	11.1	9.6	13.0	10.9	15.0	11.8	16.0	12.1	16.7	12.2	17.9	12.3	19.2	12.2
	12	11.1	9.6	13.0	10.9	15.0	11.8	16.0	12.1	16.6	12.1	17.8	12.2	19.1	12.1
	14	11.1	9.6	13.0	10.9	15.0	11.8	16.0	12.1	16.6	12.1	17.8	12.2	19.1	12.1
	16	11.1	9.6	13.0	10.9	15.0	11.8	16.0	12.1	16.6	12.1	17.8	12.2	19.0	12.0
	18	11.1	9.6	13.0	10.9	15.0	11.8	16.0	12.1	16.6	12.1	17.7	12.1	19.0	12.0
	20	11.1	9.6	13.0	10.9	15.0	11.8	16.0	12.1	16.6	12.1	17.7	12.1	18.9	11.9
	21	11.1	9.6	13.0	10.9	15.0	11.8	16.0	12.1	16.6	12.1	17.7	12.1	18.9	11.9
	23	11.1	9.6	13.0	10.9	15.0	11.8	16.0	12.1	16.6	12.1	17.7	12.1	18.9	11.9
	25	11.1	9.6	13.0	10.9	15.0	11.8	16.0	12.1	16.6	12.1	17.7	12.1	18.9	11.9
	27	11.1	9.6	13.0	10.9	15.0	11.8	16.0	12.1	16.6	12.1	17.7	12.1	18.9	11.9
	29	11.1	9.6	13.0	10.9	15.0	11.8	16.0	12.1	16.6	12.1	17.7	12.1	18.9	11.9
	31	11.1	9.6	13.0	10.9	15.0	11.8	16.0	12.1	16.6	12.1	17.7	12.1	18.9	11.9
	33	11.1	9.6	13.0	10.9	15.0	11.8	16.0	12.1	16.6	12.1	17.7	12.1	18.9	11.9
	35	11.1	9.6	13.0	10.9	15.0	11.8	16.0	12.1	16.6	12.1	17.7	12.1	18.9	11.9
	37	11.1	9.6	13.0	10.9	15.0	11.8	16.0	12.1	16.6	12.1	17.6	12.0	18.6	11.8
	39	11.1	9.6	13.0	10.9	15.0	11.8	16.0	12.1	16.5	12.0	17.3	11.8	18.2	11.5
42	11.1	9.6	13.0	10.9	14.9	11.7	15.8	11.9	16.3	11.8	17.0	11.6	17.7	11.2	
44	11.1	9.6	13.0	10.9	14.5	11.4	15.3	11.6	15.8	11.5	16.3	11.1	17.1	10.9	
46	11.1	9.6	12.9	10.7	14.2	11.2	14.8	11.2	15.3	11.2	15.8	10.7	16.6	10.6	
48	10.9	9.5	12.7	10.6	14.0	11.0	14.4	10.9	15.0	10.9	15.3	10.4	16.1	10.2	

2 Capacity Table

MSP Duct

Heating

TC : Total Capacity(kW)

Capacity Index	Outdoor Air Temp. (°C)		Indoor temperature (°C,DB)				
			16(°C,DB)	18(°C,DB)	20(°C,DB)	22(°C,DB)	24(°C,DB)
	DB	WB	TC kW	TC kW	TC kW	TC kW	TC kW
022	-19.8	-20.0	1.5	1.5	1.5	1.5	1.5
	-18.8	-19.0	1.5	1.5	1.5	1.5	1.5
	-16.7	-17.0	1.6	1.6	1.6	1.6	1.6
	-14.7	-15.0	1.7	1.6	1.6	1.6	1.6
	-12.6	-13.0	1.8	1.8	1.8	1.8	1.7
	-10.5	-11.0	2.0	2.0	1.9	1.9	1.9
	-9.5	-10.0	2.1	2.0	2.0	1.9	1.9
	-8.5	-9.1	2.2	2.1	2.1	2.0	2.0
	-7.0	-7.6	2.3	2.2	2.2	2.0	2.0
	-5.0	-5.6	2.4	2.3	2.3	2.2	2.2
	-3.0	-3.7	2.5	2.5	2.4	2.3	2.2
	0.0	-0.7	2.6	2.5	2.5	2.3	2.2
	3.0	2.2	2.7	2.6	2.5	2.3	2.2
	5.0	4.1	2.8	2.7	2.5	2.3	2.2
	7.0	6.0	2.8	2.7	2.5	2.3	2.2
9.0	7.9	3.0	2.7	2.5	2.3	2.2	
11.0	9.8	3.0	2.7	2.5	2.3	2.2	
13.0	11.8	3.0	2.7	2.5	2.3	2.2	
15.0	13.7	3.0	2.7	2.5	2.3	2.2	
028	-19.8	-20.0	1.9	1.9	1.9	1.9	1.9
	-18.8	-19.0	1.9	1.9	1.9	1.9	1.9
	-16.7	-17.0	2.0	2.0	2.0	2.0	1.9
	-14.7	-15.0	2.1	2.1	2.0	2.0	1.9
	-12.6	-13.0	2.2	2.2	2.2	2.1	2.1
	-10.5	-11.0	2.3	2.3	2.3	2.3	2.2
	-9.5	-10.0	2.3	2.3	2.3	2.3	2.2
	-8.5	-9.1	2.4	2.4	2.4	2.4	2.3
	-7.0	-7.6	2.5	2.4	2.4	2.4	2.3
	-5.0	-5.6	2.6	2.6	2.5	2.5	2.4
	-3.0	-3.7	2.8	2.7	2.7	2.6	2.5
	0.0	-0.7	2.9	2.8	2.8	2.7	2.6
	3.0	2.2	3.0	3.0	2.9	2.8	2.7
	5.0	4.1	3.2	3.1	3.1	2.9	2.7
	7.0	6.0	3.3	3.2	3.2	3.0	2.7
9.0	7.9	3.4	3.3	3.2	3.0	2.7	
11.0	9.8	3.5	3.3	3.2	3.0	2.7	
13.0	11.8	3.6	3.4	3.2	3.0	2.7	
15.0	13.7	3.7	3.4	3.2	3.0	2.7	
036	-19.8	-20.0	2.4	2.4	2.3	2.3	2.3
	-18.8	-19.0	2.5	2.4	2.3	2.3	2.3
	-16.7	-17.0	2.6	2.5	2.4	2.4	2.3
	-14.7	-15.0	2.7	2.6	2.5	2.5	2.4
	-12.6	-13.0	2.8	2.7	2.7	2.6	2.6
	-10.5	-11.0	2.9	2.9	2.9	2.8	2.8
	-9.5	-10.0	2.9	2.9	2.9	2.8	2.8
	-8.5	-9.1	3.0	3.0	3.0	2.9	2.9
	-7.0	-7.6	3.1	3.1	3.0	3.0	2.9
	-5.0	-5.6	3.3	3.2	3.2	3.1	3.0
	-3.0	-3.7	3.4	3.4	3.3	3.2	3.1
	0.0	-0.7	3.6	3.6	3.5	3.4	3.2
	3.0	2.2	3.8	3.7	3.7	3.5	3.4
	5.0	4.1	3.9	3.9	3.8	3.6	3.4
	7.0	6.0	4.1	4.1	4.0	3.7	3.4
9.0	7.9	4.2	4.1	4.0	3.7	3.4	
11.0	9.8	4.4	4.2	4.0	3.7	3.4	
13.0	11.8	4.5	4.2	4.0	3.7	3.4	
15.0	13.7	4.6	4.3	4.0	3.7	3.4	

2 Capacity Table

MSP Duct

Heating

TC : Total Capacity(kW)

Capacity Index	Outdoor Air Temp. (°C)		Indoor temperature (°C,DB)				
			16(°C,DB)	18(°C,DB)	20(°C,DB)	22(°C,DB)	24(°C,DB)
	DB	WB	TC kW	TC kW	TC kW	TC kW	TC kW
045	-19.8	-20.0	3.1	3.1	2.9	2.9	2.9
	-18.8	-19.0	3.1	3.1	3.0	2.9	2.9
	-16.7	-17.0	3.2	3.2	3.1	3.0	3.0
	-14.7	-15.0	3.3	3.3	3.2	3.1	3.0
	-12.6	-13.0	3.5	3.4	3.4	3.3	3.2
	-10.5	-11.0	3.7	3.6	3.6	3.5	3.4
	-9.5	-10.0	3.7	3.6	3.6	3.5	3.5
	-8.5	-9.1	3.8	3.7	3.7	3.6	3.6
	-7.0	-7.6	3.9	3.8	3.8	3.7	3.6
	-5.0	-5.6	4.1	4.0	4.0	3.9	3.7
	-3.0	-3.7	4.3	4.2	4.2	4.0	3.9
	0.0	-0.7	4.5	4.4	4.4	4.2	4.0
	3.0	2.2	4.7	4.7	4.6	4.4	4.2
	5.0	4.1	4.9	4.9	4.8	4.5	4.2
	7.0	6.0	5.1	5.1	5.0	4.6	4.2
9.0	7.9	5.3	5.2	5.0	4.6	4.2	
11.0	9.8	5.5	5.2	5.0	4.6	4.2	
13.0	11.8	5.6	5.3	5.0	4.6	4.2	
15.0	13.7	5.8	5.4	5.0	4.6	4.2	
056	-19.8	-20.0	3.9	3.8	3.8	3.7	3.7
	-18.8	-19.0	3.9	3.9	3.8	3.7	3.7
	-16.7	-17.0	4.0	4.0	3.9	3.8	3.8
	-14.7	-15.0	4.2	4.1	4.0	3.9	3.8
	-12.6	-13.0	4.4	4.3	4.2	4.1	4.0
	-10.5	-11.0	4.6	4.5	4.4	4.4	4.3
	-9.5	-10.0	4.7	4.6	4.6	4.5	4.4
	-8.5	-9.1	4.8	4.7	4.7	4.6	4.5
	-7.0	-7.6	4.9	4.8	4.8	4.7	4.5
	-5.0	-5.6	5.2	5.1	5.0	4.9	4.7
	-3.0	-3.7	5.4	5.3	5.3	5.1	4.9
	0.0	-0.7	5.7	5.6	5.5	5.3	5.0
	3.0	2.2	5.9	5.9	5.8	5.6	5.3
	5.0	4.1	6.2	6.1	6.0	5.7	5.3
	7.0	6.0	6.5	6.4	6.3	5.8	5.3
9.0	7.9	6.7	6.5	6.3	5.8	5.3	
11.0	9.8	6.9	6.6	6.3	5.8	5.3	
13.0	11.8	7.1	6.7	6.3	5.8	5.3	
15.0	13.7	7.3	6.8	6.3	5.8	5.3	
071	-19.8	-20.0	4.9	4.9	4.8	4.7	4.7
	-18.8	-19.0	5.0	4.9	4.8	4.7	4.7
	-16.7	-17.0	5.1	5.0	4.9	4.8	4.8
	-14.7	-15.0	5.3	5.2	5.1	4.9	4.8
	-12.6	-13.0	5.5	5.4	5.3	5.2	5.1
	-10.5	-11.0	5.8	5.7	5.6	5.5	5.5
	-9.5	-10.0	6.0	5.9	5.8	5.7	5.6
	-8.5	-9.1	6.1	6.0	5.9	5.8	5.7
	-7.0	-7.6	6.2	6.1	6.0	5.9	5.8
	-5.0	-5.6	6.5	6.5	6.4	6.2	6.0
	-3.0	-3.7	6.9	6.8	6.7	6.4	6.2
	0.0	-0.7	7.2	7.1	7.0	6.7	6.4
	3.0	2.2	7.6	7.5	7.3	7.1	6.8
	5.0	4.1	7.9	7.8	7.7	7.2	6.8
	7.0	6.0	8.2	8.1	8.0	7.4	6.8
9.0	7.9	8.5	8.2	8.0	7.4	6.8	
11.0	9.8	8.7	8.4	8.0	7.4	6.8	
13.0	11.8	9.0	8.5	8.0	7.4	6.8	
15.0	13.7	9.2	8.6	8.0	7.4	6.8	

2 Capacity Table

MSP Duct

Heating

TC : Total Capacity(kW)

Capacity Index	Outdoor Air Temp. (°C)		Indoor temperature (°C,DB)				
			16(°C,DB)	18(°C,DB)	20(°C,DB)	22(°C,DB)	24(°C,DB)
	DB	WB	TC kW	TC kW	TC kW	TC kW	TC kW
090	-19.8	-20.0	6.0	6.0	5.9	5.8	5.8
	-18.8	-19.0	6.1	6.1	6.0	5.9	5.8
	-16.7	-17.0	6.4	6.3	6.1	6.0	5.9
	-14.7	-15.0	6.7	6.5	6.3	6.2	6.1
	-12.6	-13.0	6.9	6.8	6.6	6.5	6.4
	-10.5	-11.0	7.2	7.1	7.0	6.9	6.9
	-9.5	-10.0	7.4	7.3	7.2	7.1	7.0
	-8.5	-9.1	7.6	7.5	7.4	7.2	7.1
	-7.0	-7.6	7.8	7.7	7.6	7.4	7.2
	-5.0	-5.6	8.2	8.1	8.0	7.7	7.5
	-3.0	-3.7	8.6	8.5	8.4	8.1	7.7
	0.0	-0.7	9.0	8.9	8.8	8.4	8.0
	3.0	2.2	9.4	9.3	9.2	8.8	8.4
	5.0	4.1	9.9	9.7	9.6	9.0	8.4
	7.0	6.0	10.3	10.1	10.0	9.2	8.4
9.0	7.9	10.6	10.3	10.0	9.2	8.4	
11.0	9.8	10.9	10.5	10.0	9.2	8.4	
13.0	11.8	11.2	10.6	10.0	9.2	8.4	
15.0	13.7	11.6	10.8	10.0	9.2	8.4	
112	-19.8	-20.0	7.4	7.4	7.3	7.3	7.3
	-18.8	-19.0	7.6	7.6	7.4	7.4	7.3
	-16.7	-17.0	8.1	7.8	7.6	7.5	7.4
	-14.7	-15.0	8.4	8.2	8.0	7.8	7.6
	-12.6	-13.0	8.7	8.5	8.3	8.1	8.0
	-10.5	-11.0	9.1	8.9	8.8	8.7	8.6
	-9.5	-10.0	9.3	9.1	9.0	8.9	8.8
	-8.5	-9.1	9.5	9.3	9.2	9.0	8.9
	-7.0	-7.6	9.7	9.6	9.4	9.2	9.0
	-5.0	-5.6	10.2	10.1	9.9	9.6	9.3
	-3.0	-3.7	10.7	10.6	10.5	10.1	9.7
	0.0	-0.7	11.3	11.1	11.1	10.5	10.0
	3.0	2.2	11.8	11.6	11.5	11.0	10.6
	5.0	4.1	12.3	12.2	12.0	11.3	10.6
	7.0	6.0	12.9	12.7	12.5	11.5	10.6
9.0	7.9	13.3	12.9	12.5	11.5	10.6	
11.0	9.8	13.7	13.1	12.5	11.5	10.6	
13.0	11.8	14.0	13.3	12.5	11.5	10.6	
15.0	13.7	14.4	13.5	12.5	11.5	10.6	
128	-19.8	-20.0	8.1	8.1	8.0	8.0	8.0
	-18.8	-19.0	8.3	8.3	8.2	8.1	8.0
	-16.7	-17.0	8.8	8.6	8.4	8.3	8.1
	-14.7	-15.0	9.3	9.1	8.8	8.6	8.3
	-12.6	-13.0	9.6	9.4	9.2	9.0	8.8
	-10.5	-11.0	10.0	9.9	9.8	9.6	9.4
	-9.5	-10.0	10.2	10.1	10.0	9.8	9.7
	-8.5	-9.1	10.4	10.3	10.2	10.0	9.8
	-7.0	-7.6	10.7	10.6	10.4	10.2	10.0
	-5.0	-5.6	11.3	11.1	11.0	10.7	10.3
	-3.0	-3.7	11.9	11.7	11.5	11.1	10.7
	0.0	-0.7	12.4	12.3	12.1	11.6	11.0
	3.0	2.2	13.0	12.9	12.7	12.2	11.7
	5.0	4.1	13.6	13.4	13.2	12.4	11.7
	7.0	6.0	14.2	14.0	13.8	12.7	11.7
9.0	7.9	14.6	14.2	13.8	12.7	11.7	
11.0	9.8	15.1	14.4	13.8	12.7	11.7	
13.0	11.8	15.5	14.7	13.8	12.7	11.7	
15.0	13.7	15.9	14.9	13.8	12.7	11.7	

2 Capacity Table

MSP Duct

Heating

TC : Total Capacity(kW)

Capacity Index	Outdoor Air Temp. (°C)		Indoor temperature (°C,DB)				
			16(°C,DB)	18(°C,DB)	20(°C,DB)	22(°C,DB)	24(°C,DB)
	DB	WB	TC kW	TC kW	TC kW	TC kW	TC kW
140	-19.8	-20.0	9.5	9.5	9.4	9.4	9.3
	-18.8	-19.0	9.7	9.7	9.5	9.5	9.3
	-16.7	-17.0	10.2	10.0	9.7	9.6	9.4
	-14.7	-15.0	10.8	10.5	10.2	9.9	9.6
	-12.6	-13.0	11.1	10.9	10.7	10.4	10.1
	-10.5	-11.0	11.6	11.5	11.3	11.1	10.9
	-9.5	-10.0	11.8	11.7	11.5	11.4	11.2
	-8.5	-9.1	12.1	11.9	11.8	11.6	11.3
	-7.0	-7.6	12.4	12.2	12.1	11.8	11.5
	-5.0	-5.6	13.1	12.9	12.7	12.3	12.0
	-3.0	-3.7	13.8	13.6	13.4	12.9	12.4
	0.0	-0.7	14.4	14.2	14.0	13.4	12.8
	3.0	2.2	15.1	14.9	14.7	14.1	13.5
	5.0	4.1	15.8	15.6	15.3	14.4	13.5
	7.0	6.0	16.5	16.2	16.0	14.8	13.5
9.0	7.9	17.0	16.5	16.0	14.8	13.5	
11.0	9.8	17.5	16.7	16.0	14.8	13.5	
13.0	11.8	18.0	17.0	16.0	14.8	13.5	
15.0	13.7	18.5	17.2	16.0	14.8	13.5	
160	-19.8	-20.0	14.6	14.1	13.3	12.6	12.2
	-18.8	-19.0	14.8	14.2	13.4	12.9	12.5
	-16.7	-17.0	15.1	14.5	13.7	13.3	13.2
	-14.7	-15.0	15.7	15.0	14.2	13.8	13.6
	-12.6	-13.0	16.4	15.7	14.9	14.4	14.2
	-10.5	-11.0	17.5	16.8	15.9	15.2	15.0
	-9.5	-10.0	17.9	17.1	16.2	15.5	15.3
	-8.5	-9.1	18.0	17.3	16.3	15.7	15.5
	-7.0	-7.6	18.3	17.6	16.6	16.1	15.8
	-5.0	-5.6	18.9	18.1	17.1	16.7	16.3
	-3.0	-3.7	19.3	18.6	17.5	17.4	16.6
	0.0	-0.7	19.7	19.1	17.9	17.5	17.1
	3.0	2.2	20.2	19.4	18.0	17.6	17.0
	5.0	4.1	20.4	19.4	18.0	17.6	17.0
	7.0	6.0	20.7	19.4	18.0	17.6	17.0
9.0	7.9	20.7	19.4	18.0	17.6	17.0	
11.0	9.8	20.7	19.4	18.0	17.6	17.0	
13.0	11.8	20.7	19.4	18.0	17.6	17.0	
15.0	13.7	20.7	19.4	18.0	17.6	17.0	

3 Dimensional Drawing

MSP Duct

AM022/028/036*NMDEH/EU

[Unit : mm]

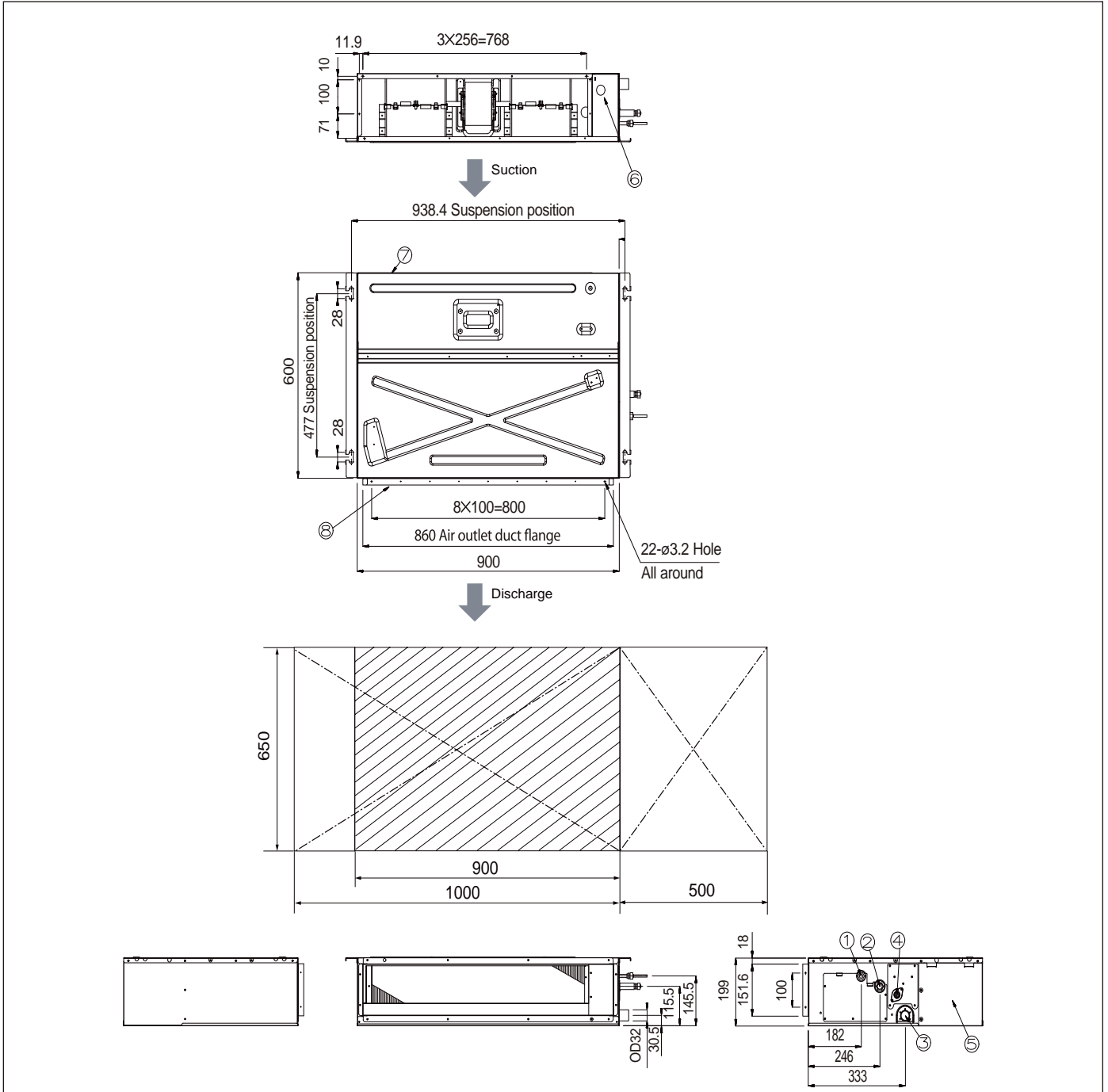

No.	Name	Description		
		2.2kW	2.8kW	3.6kW
①	Liquid pipe connection	Ø6.35 Flare		
②	Gas pipe connection	Ø12.70 Flare		
③	Drain pipe connection without drain pump	VP25 (OD 32, ID 25)		
④	Drain pipe connection with drain pump	VP25 (OD 32, ID 25)		
⑤	Control unit	-		
⑥	Conduit for power supply & communication wiring	-		
⑦	Return air side	-		
⑧	Air outlet duct flange	-		

3 Dimensional Drawing

MSP Duct

AM045/056/071*NMDEH/EU

[Unit : mm]

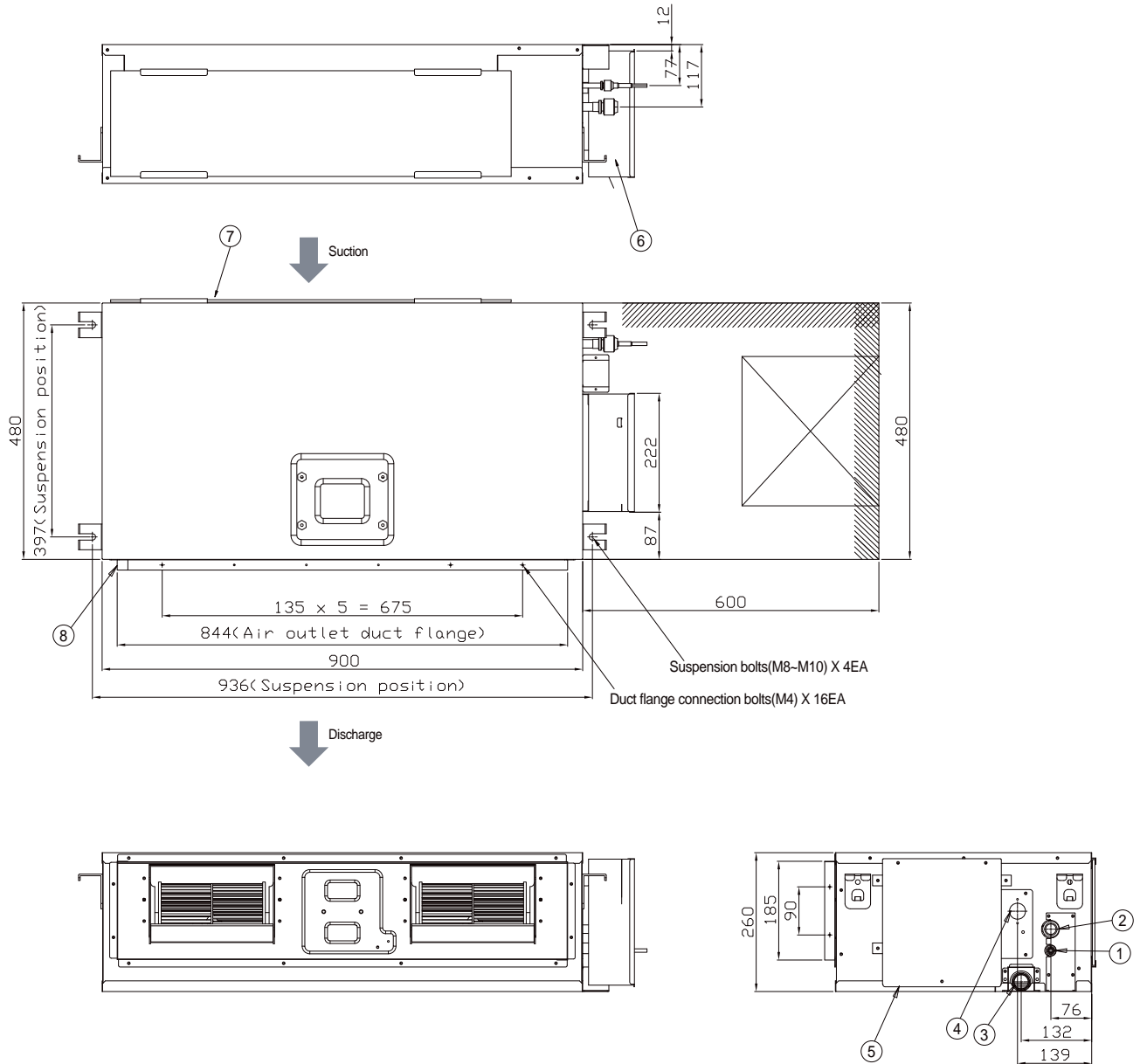

No.	Name	Description		
		4.5kW	5.6kW	7.1kW
①	Liquid pipe connection	Ø6.35 Flare		Ø9.52 Flare
②	Gas pipe connection	Ø12.70 Flare		Ø15.88 Flare
③	Drain pipe connection without drain pump	VP25 (OD 32, ID 25)		
④	Drain pipe connection with drain pump	VP25 (OD 32, ID 25)		
⑤	Control unit	-		
⑥	Conduit for power supply & communication wiring	-		
⑦	Return air side	-		
⑧	Air outlet duct flange	-		

3 Dimensional Drawing

MSP Duct

AM090*NMDEH/EU

[Unit : mm]

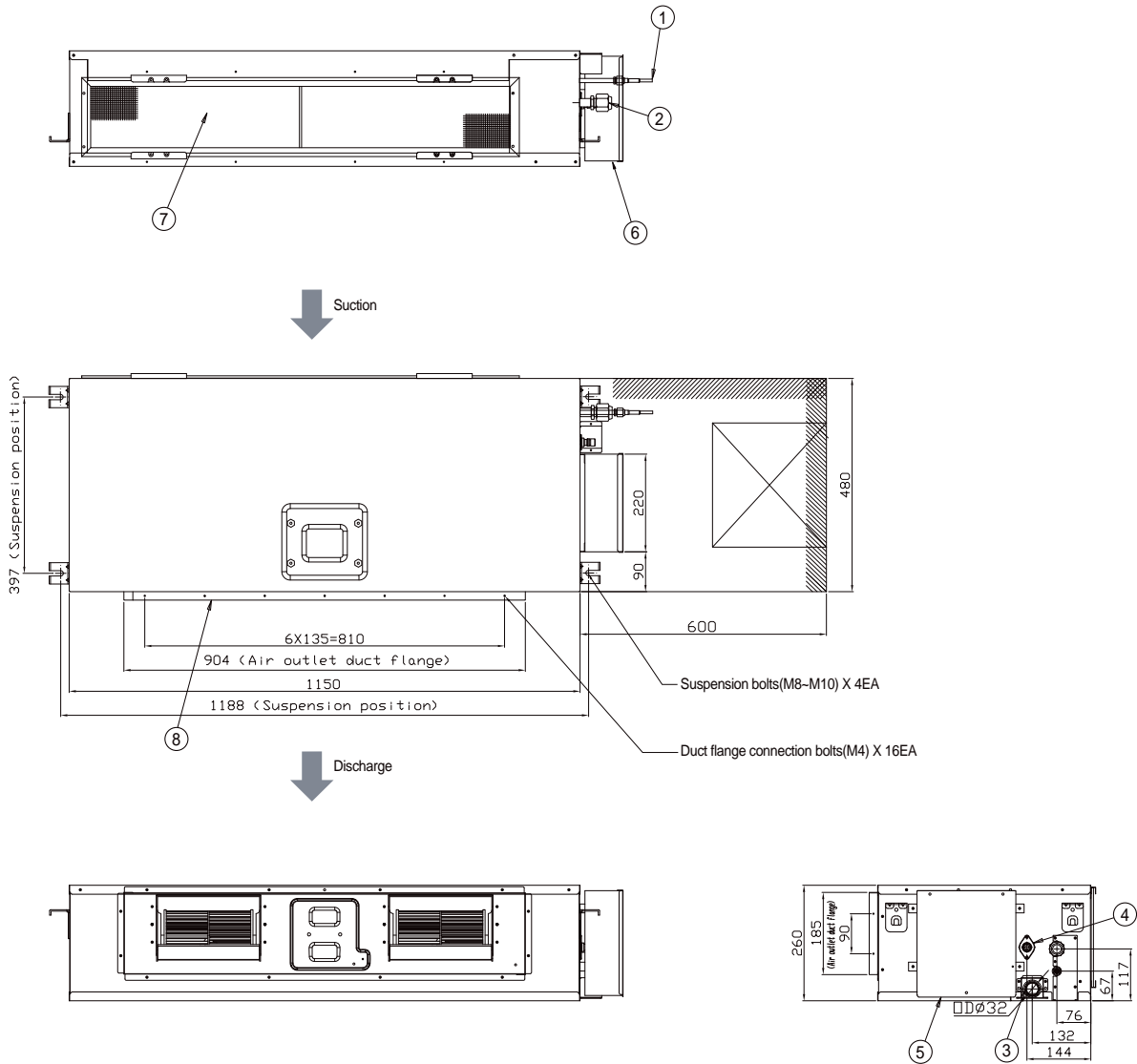

No.	Name	Description
		9.0kW
①	Liquid pipe connection	Ø9.52 Flare
②	Gas pipe connection	Ø15.88 Flare
③	Drain pipe connection without drain pump	VP25 (OD 32, ID 25)
④	Drain pipe connection with drain pump	VP25 (OD 32, ID 25)
⑤	Control unit	-
⑥	Conduit for power supply & communication wiring	-
⑦	Return air side	-
⑧	Air outlet duct flange	-

3 Dimensional Drawing

MSP Duct

AM112*NMDEH/EU

[Unit : mm]

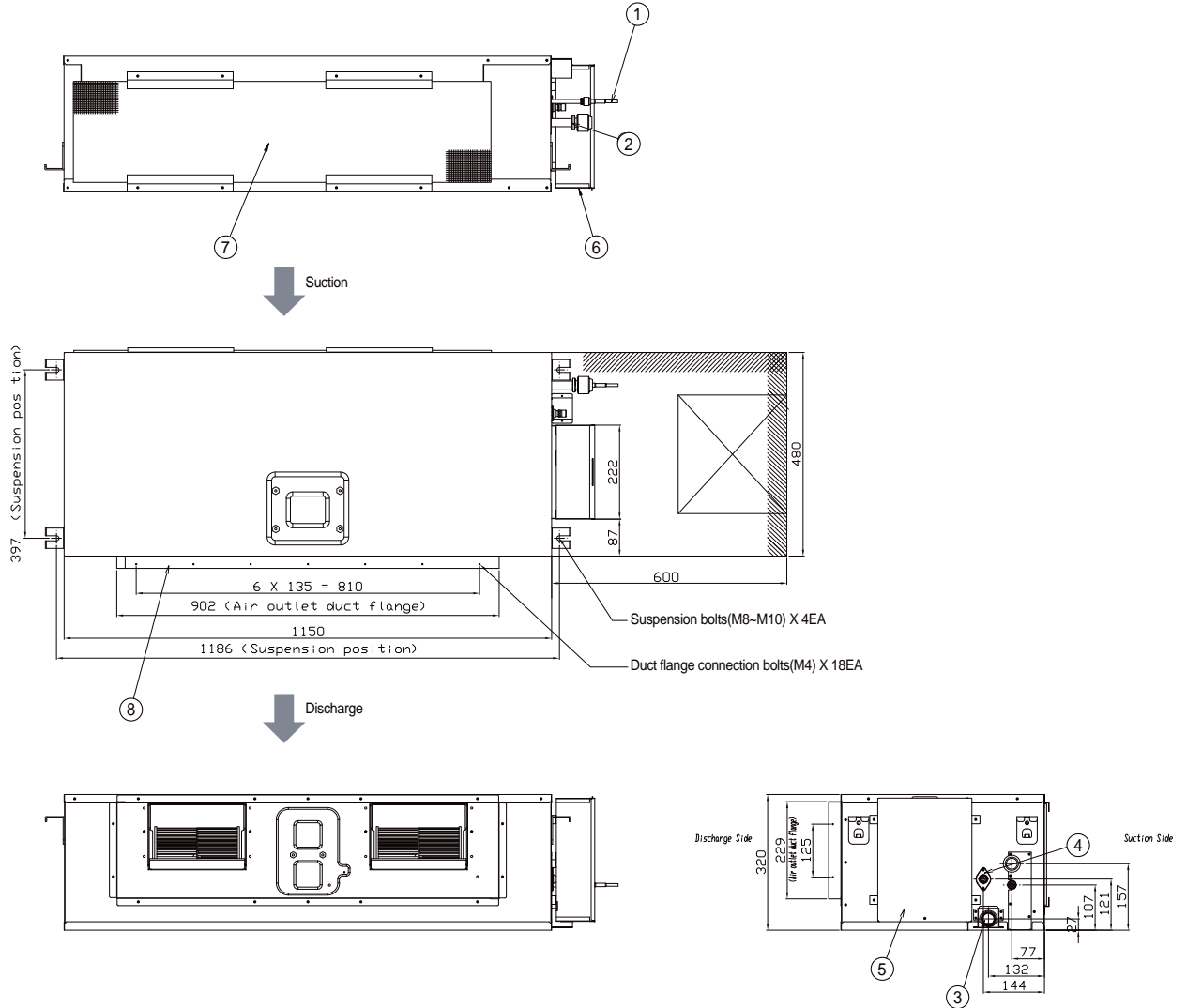

No.	Name	Description
		11.2kW
①	Liquid pipe connection	Ø9.52 Flare
②	Gas pipe connection	Ø15.88 Flare
③	Drain pipe connection without drain pump	VP25 (OD 32, ID 25)
④	Drain pipe connection with drain pump	VP25 (OD 32, ID 25)
⑤	Control unit	-
⑥	Conduit for power supply & communication wiring	-
⑦	Return air side	-
⑧	Air outlet duct flange	-

3 Dimensional Drawing

MSP Duct

AM128/140/160*NMDEH*EU

[Unit : mm]

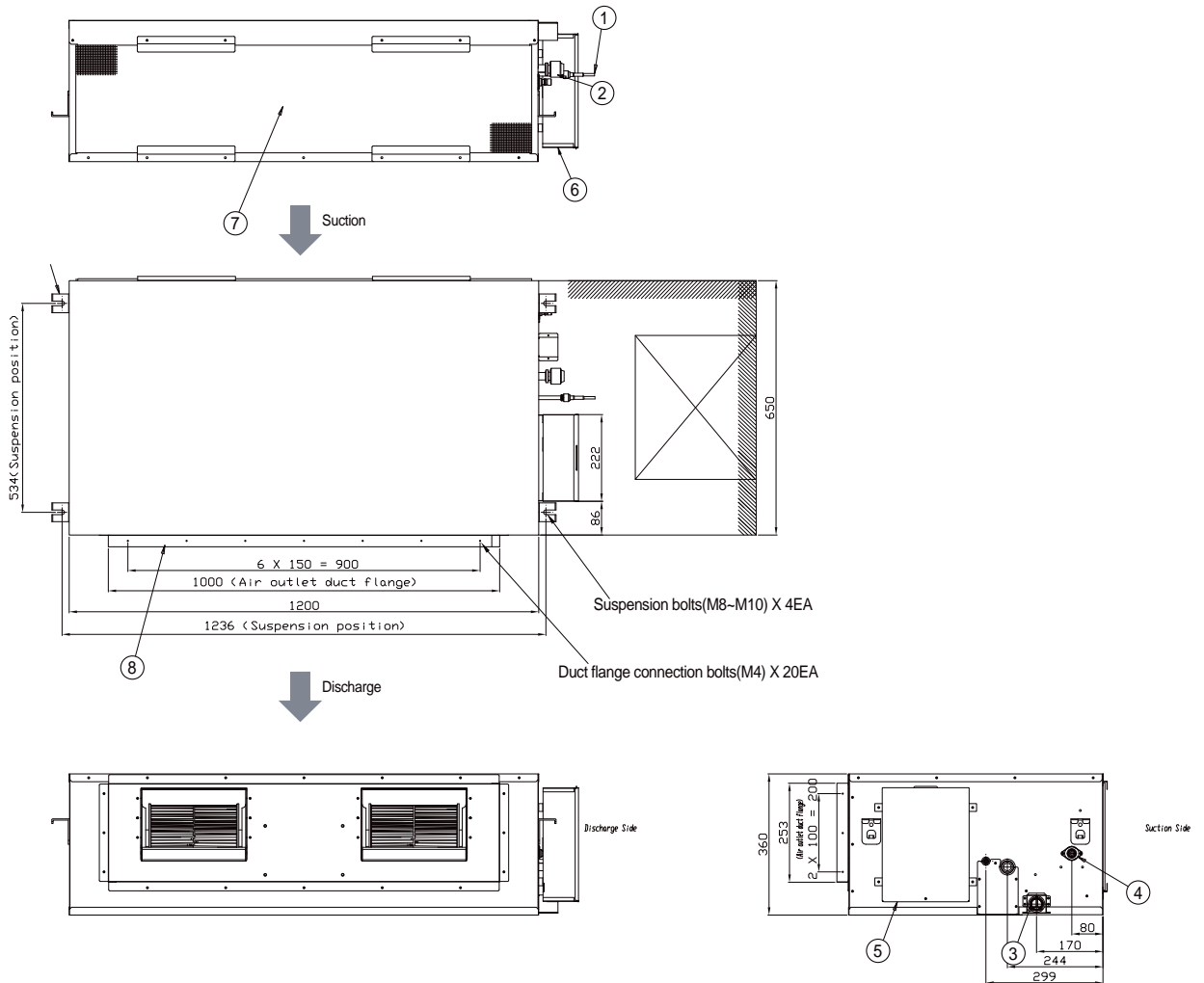

No.	Name	Description		
		12.8kW	14.0kW	16.0kW
①	Liquid pipe connection	Ø9.52 Flare		
②	Gas pipe connection	Ø15.88 Flare		
③	Drain pipe connection without drain pump	VP25 (OD 32, ID 25)		
④	Drain pipe connection with drain pump	VP25 (OD 32, ID 25)		
⑤	Control unit	-		
⑥	Conduit for power supply & communication wiring	-		
⑦	Return air side	-		
⑧	Air outlet duct flange	-		

4 Electrical Wiring Diagram

MSP Duct

AM022/028/036/045/056/071/090/112/128/140/160*NMDEH*EU

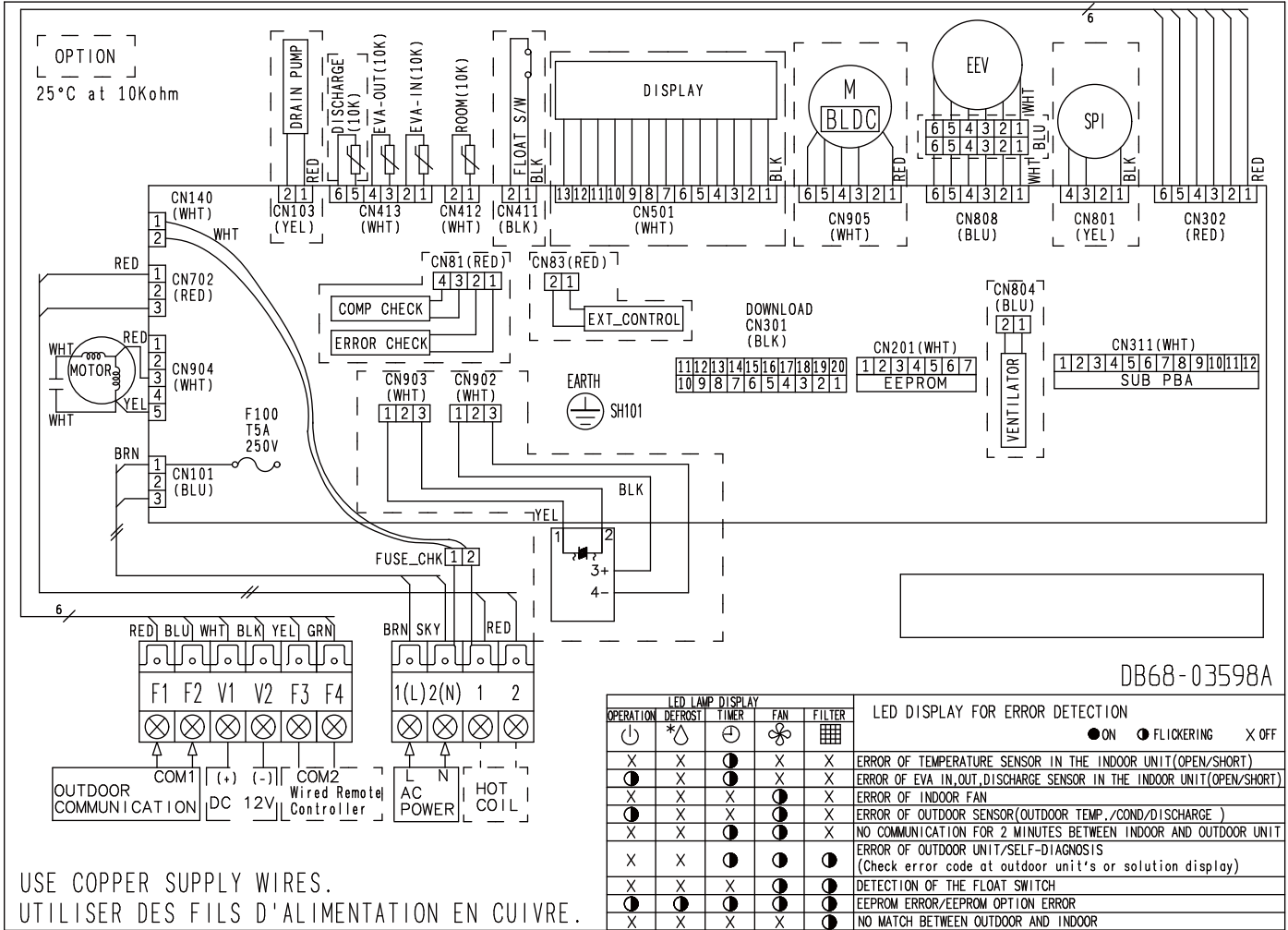

USE COPPER SUPPLY WIRES.
UTILISER DES FILS D'ALIMENTATION EN CUIVRE.

ROOM(10K)	Thermistor ROOM(10K)	EEV	electronic expansion valve	EVA-IN(10K)	Thermistor EVA IN(10K)
DISCHARGE(10K)	Thermistor DISCHARGE(10K)	SPI	S-Plasma ion	EVA-OUT(10K)	Thermistor EVA OUT(10K)

NOTE

1. This wiring diagram applies only to the indoor unit.
2. Symbols show as follow;
BLK : black, RED : red, BLU : blue, WHT:white, YEL : yellow, BRN : brown, SKY : sky-blue, GRN : green
3. For connection wiring indoor-outdoor transmission F1-F2, indoor-wired remotecontroller transmission F3-F4.
4. : Protective earth(screw), : Connector, n : The wire quantity

5 Sound Pressure Level

MSP Duct

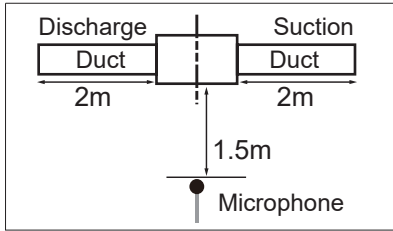

Unit: dB(A)

Model	High	Low
AM022*NMDEH/EU	23	19
AM028*NMDEH/EU	24	19
AM036*NMDEH/EU	29	24
AM045*NMDEH/EU	32	28

Note

Specifications may be subject to change without prior notice.
 Sound pressure level is obtained in an anechoic room.
 Sound pressure level is a relative value, depending on the distance and acoustic environment.
 Sound pressure level may differ depending on operation condition.
 dBA = A-weighted sound pressure level
 Reference acoustic pressure 0 dB= 20 uPa

NR curve

1) AM022*NMDEH/EU

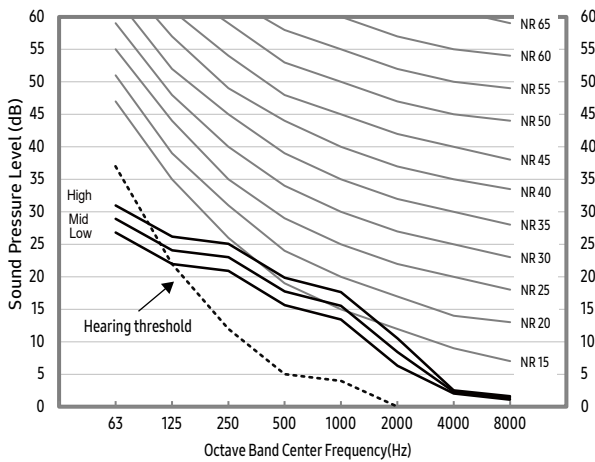

2) AM028*NMDEH/EU

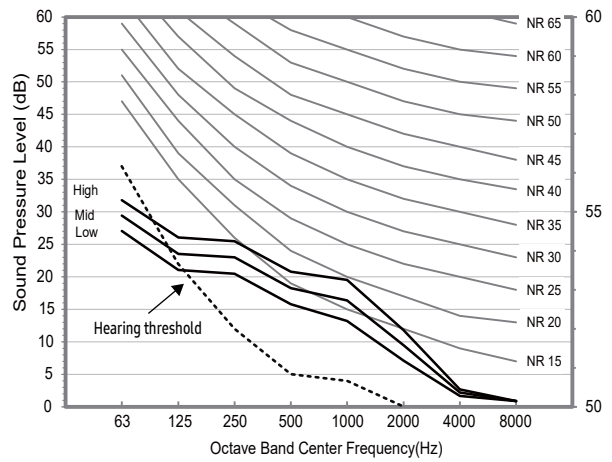

3) AM036*NMDEH/EU

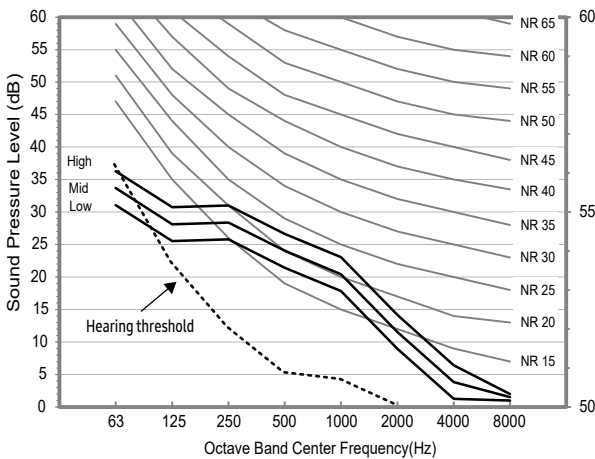

4) AM045*NMDEH/EU

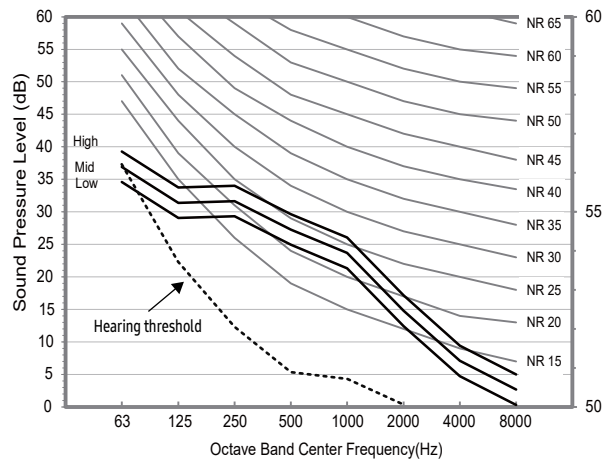

5 Sound Pressure Level

MSP Duct

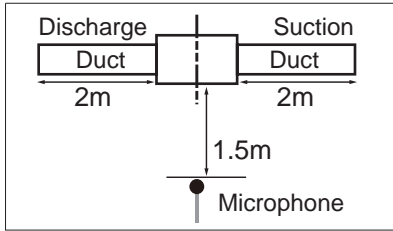

Unit: dB(A)

Model	High	Low
AM056*NMDEH/EU	35	31
AM071*NMDEH/EU	39	31
AM090*NMDEH/EU	40	34
AM112*NMDEH/EU	41	38

Note

Specifications may be subject to change without prior notice.
 Sound pressure level is obtained in an anechoic room.
 Sound pressure level is a relative value, depending on the distance and acoustic environment.
 Sound pressure level may differ depending on operation condition.
 dBA = A-weighted sound pressure level
 Reference acoustic pressure 0 dB= 20 uPa

NR curve

5) AM056*NMDEH/EU

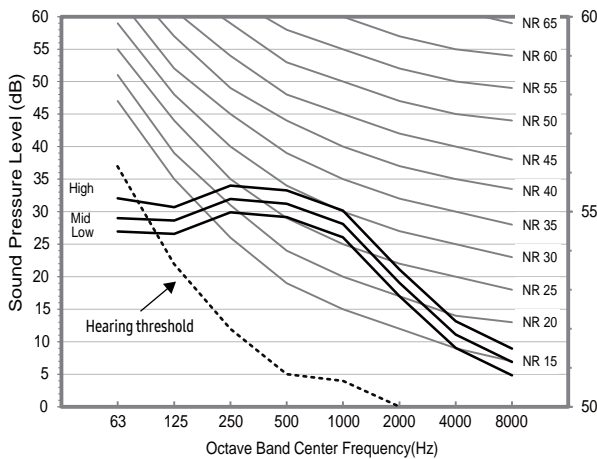

6) AM071*NMDEH/EU

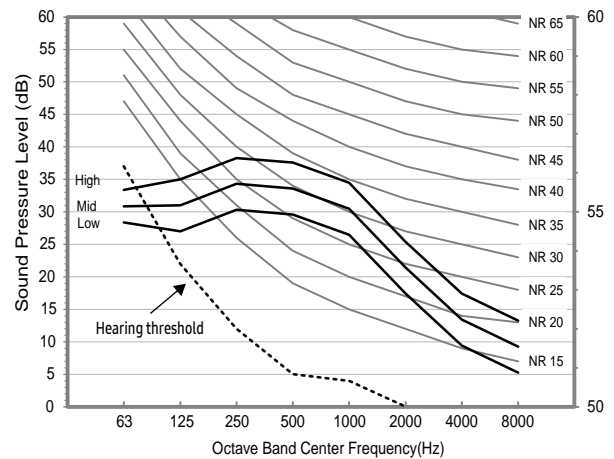

7) AM090*NMDEH/EU

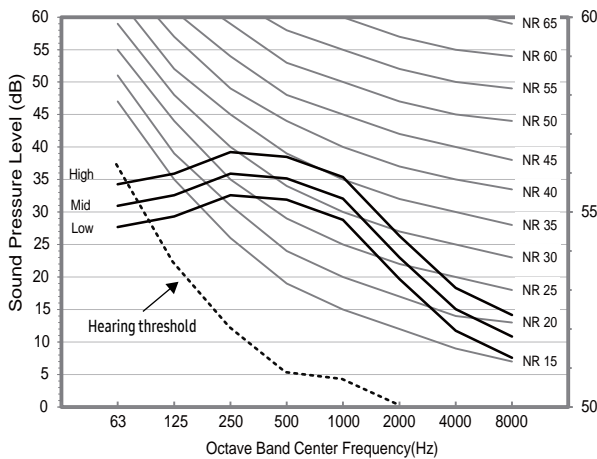

8) AM112*NMDEH/EU

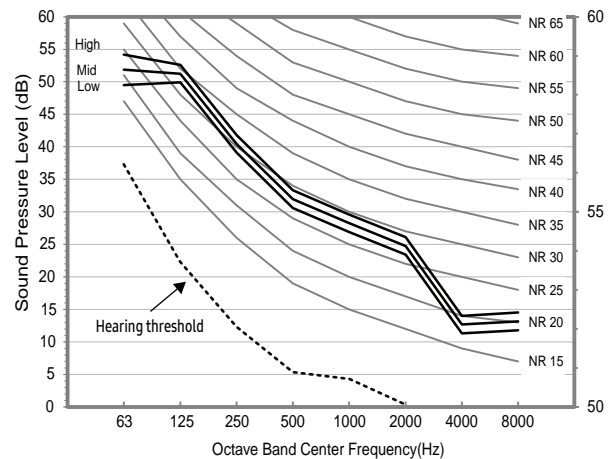

5 Sound Pressure Level

MSP Duct

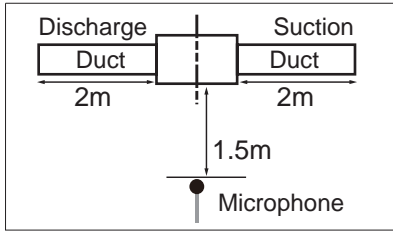

Unit: dB(A)

Model	High	Low
AM128*NMDEH/EU	41	38
AM140*NMDEH/EU	42	36
AM160*NMDEH*EU	43	36

Note

Specifications may be subject to change without prior notice.
 Sound pressure level is obtained in an anechoic room.
 Sound pressure level is a relative value, depending on the distance and acoustic environment.
 Sound pressure level may differ depending on operation condition.
 dBA = A-weighted sound pressure level
 Reference acoustic pressure 0 dB= 20 uPa

NR curve

9) AM128*NMDEH/EU

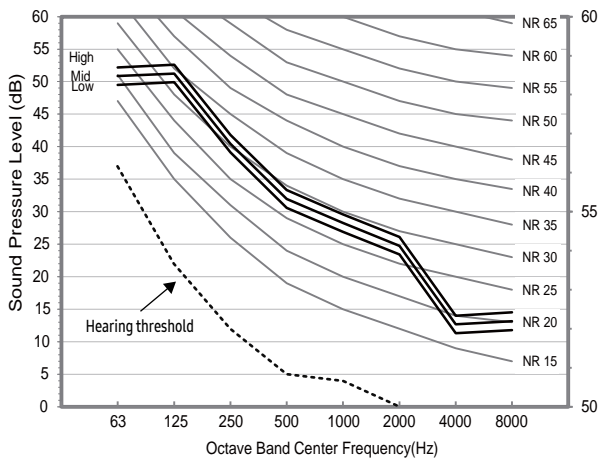

10) AM140*NMDEH/EU

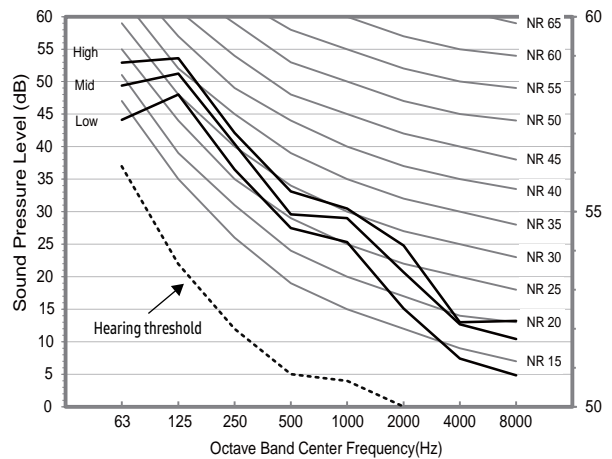

11) AM160KNMDEH*EU

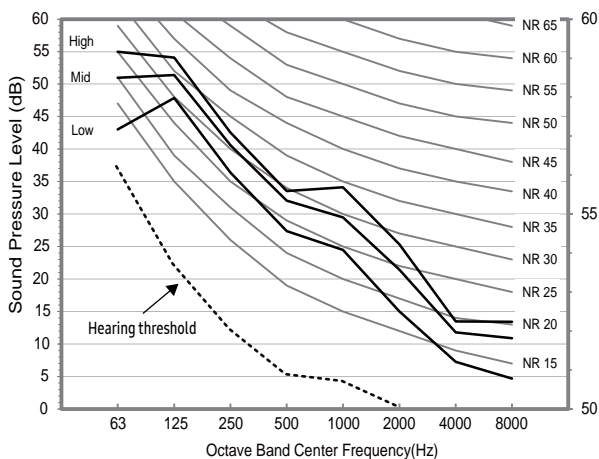

6 Sound Power Level

MSP Duct

Unit: dB(A)

Model	Power
AM022*NMDEH/EU	47
AM028*NMDEH/EU	48
AM036*NMDEH/EU	53
AM045*NMDEH/EU	54

Note

- . Specifications may be subject to change without prior notice.
- . Sound power level is an absolute value that a sound source generates.
- . dBA = A-weighted sound power level.
- . Reference power : 1pW.
- . Measured according to ISO 3741

1) AM022*NMDEH/EU

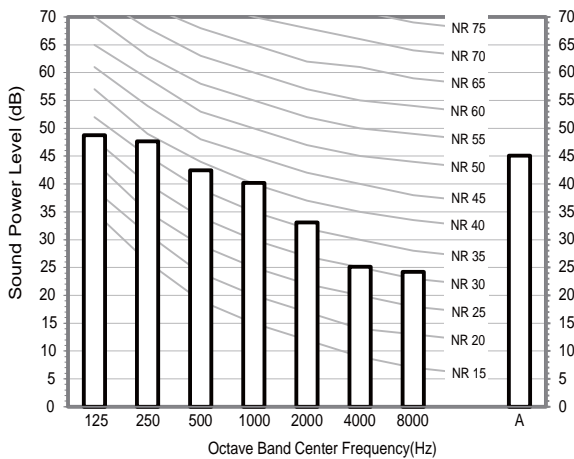

2) AM028*NMDEH/EU

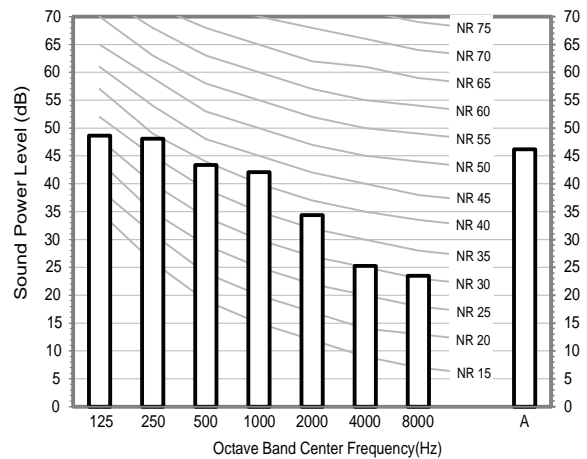

3) AM036*NMDEH/EU

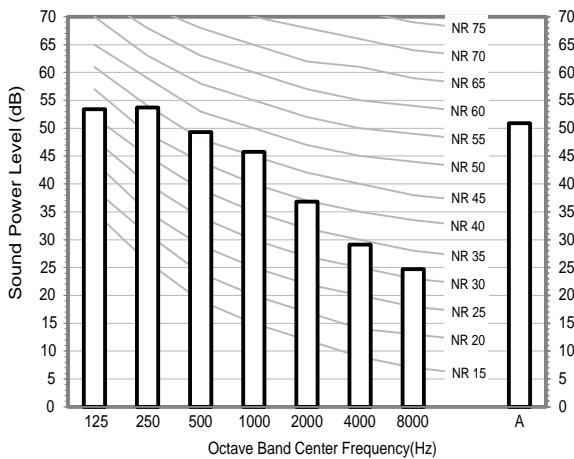

4) AM045*NMDEH/EU

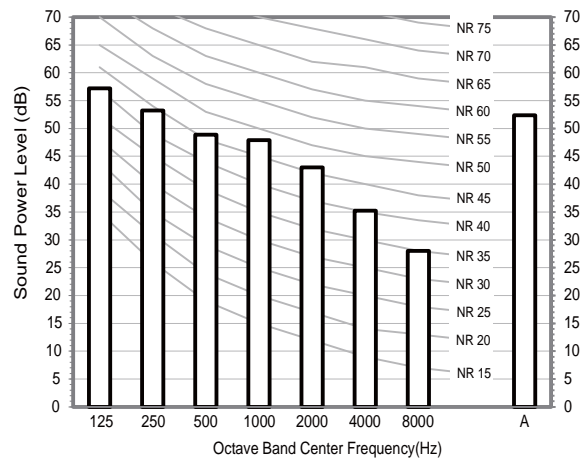

6 Sound Power Level

MSP Duct

Unit: dB(A)

Model	Power
AM056*NMDEH/EU	57
AM071*NMDEH/EU	61
AM090*NMDEH/EU	63
AM112*NMDEH/EU	66

Note

- . Specifications may be subject to change without prior notice.
- . Sound power level is an absolute value that a sound source generates.
- . dBA = A-weighted sound power level.
- . Reference power : 1pW.
- . Measured according to ISO 3741

5) AM056*NMDEH/EU

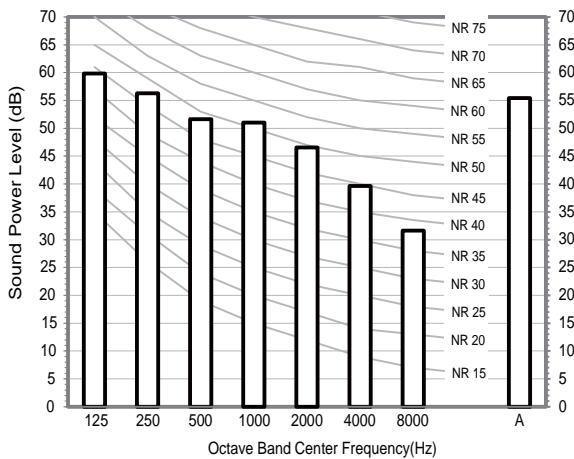

6) AM071*NMDEH/EU

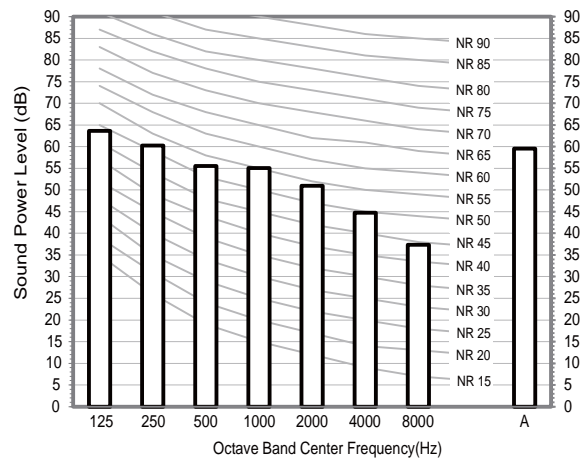

7) AM090*NMDEH/EU

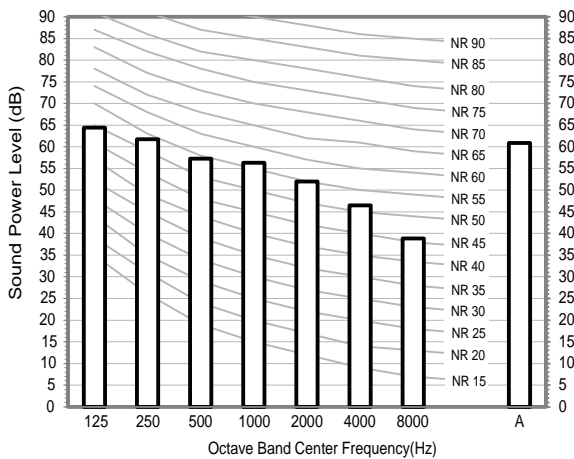

8) AM112*NMDEH/EU

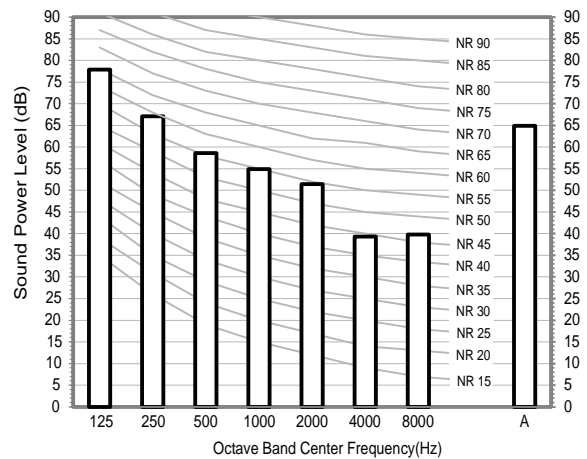

6 Sound Power Level

MSP Duct

Unit: dB(A)

Model	Power
AM128*NMDEH/EU	66
AM140*NMDEH/EU	68
AM160KNMDEH*EU	69

Note

- . Specifications may be subject to change without prior notice.
- . Sound power level is an absolute value that a sound source generates.
- . dBA = A-weighted sound power level.
- . Reference power : 1pW.
- . Measured according to ISO 3741

9) AM128*NMDEH/EU

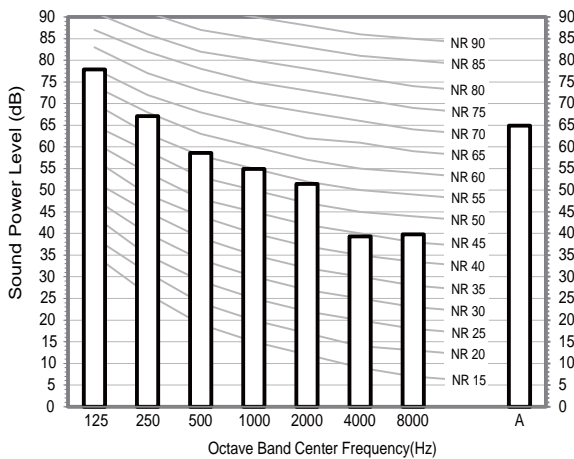

10) AM140*NMDEH/EU

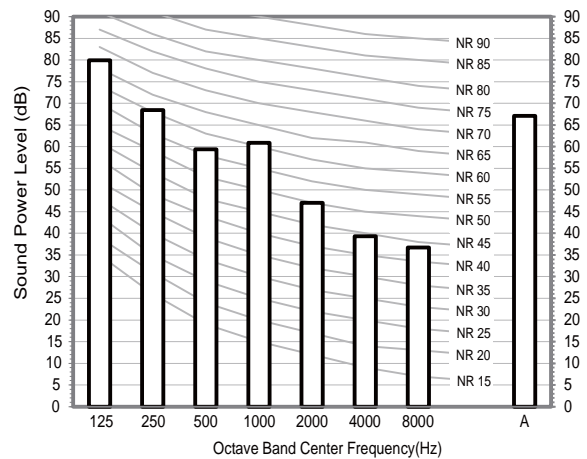

11) AM160KNMDEH*EU

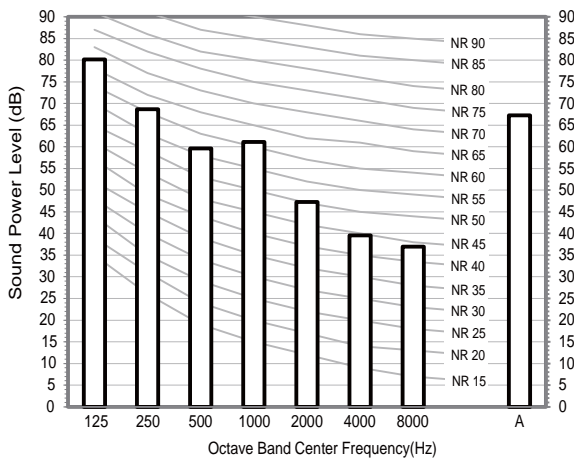

7 Fan Characteristics

MSP Duct

1) AM022*NMDEH/EU

①	External Static Pressure(mmAq)	Option Code
	$0 < SP \leq 1$	010054-1350B6-201616-331110

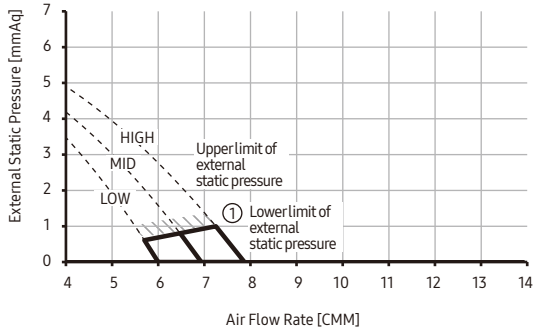

②	External Static Pressure(mmAq)	Option Code
	$1 < SP \leq 3$	010054-1350EA-201616-331110

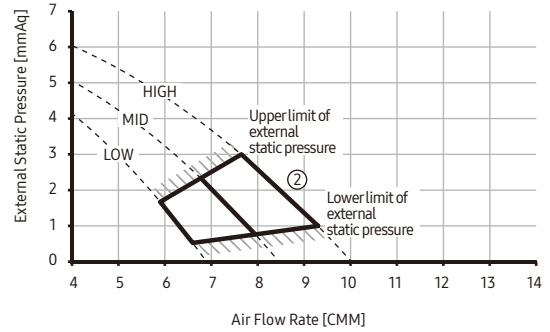

③	External Static Pressure(mmAq)	Option Code
	$3 < SP \leq 5$	010054-13541E-201616-331110

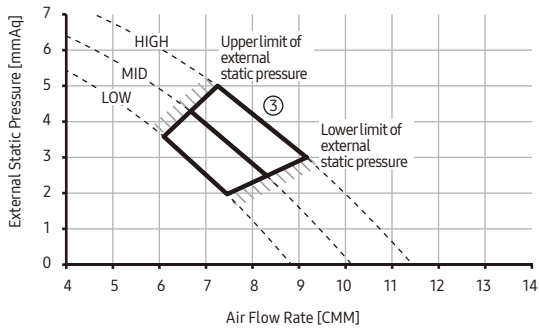

④	External Static Pressure(mmAq)	Option Code
	$5 < SP \leq 6$	010054-1355E4-201616-331110

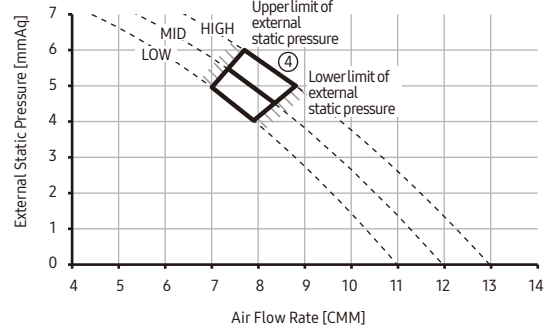

Note

Adjust option code according to the actual installation condition (external static pressure).

ESP = External Static Pressure

The graphs display the available external static pressure range of installed indoor units. Therefore, they do not reflect the actual change of external static pressure and airflow rate according to adjusted airflow (High-Mid-Low) of installed indoor units.

7 Fan Characteristics

MSP Duct

2) AM028*NMDEH/EU

①	External Static Pressure(mmAq)	Option Code
	$0 < SP \leq 1$	010054-1350E8-201C1C-331110

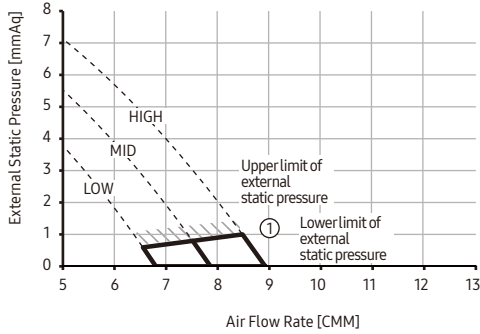

②	External Static Pressure(mmAq)	Option Code
	$1 < SP \leq 3$	010054-13542C-201C1C-331110

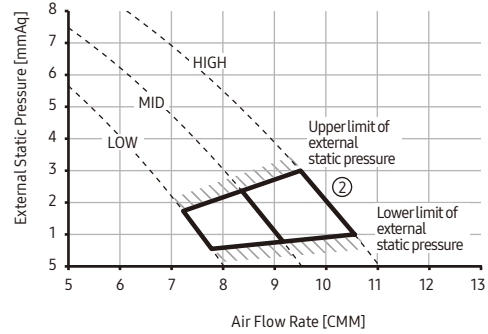

③	External Static Pressure(mmAq)	Option Code
	$3 < SP \leq 5$	010054-135562-201C1C-331110

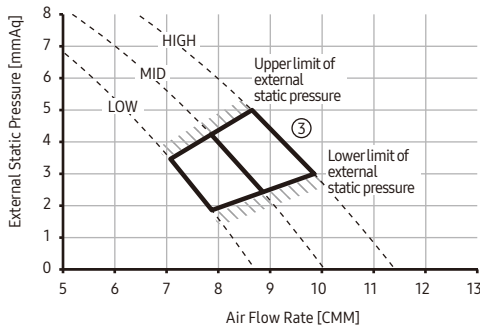

④	External Static Pressure(mmAq)	Option Code
	$5 < SP \leq 6$	010054-1359A9-201C1C-331110

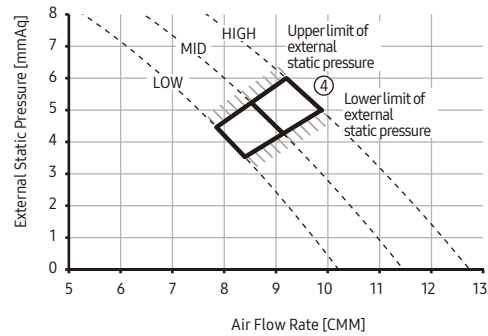

Note

Adjust option code according to the actual installation condition (external static pressure).

ESP = External Static Pressure

The graphs display the available external static pressure range of installed indoor units. Therefore, they do not reflect the actual change of external static pressure and airflow rate according to adjusted airflow (High-Mid-Low) of installed indoor units.

7 Fan Characteristics

MSP Duct

3) AM036*NMDEH/EU

①	External Static Pressure(mmAq)	Option Code
	$0 < SP \leq 1$	010054-1350EA-202424-331110

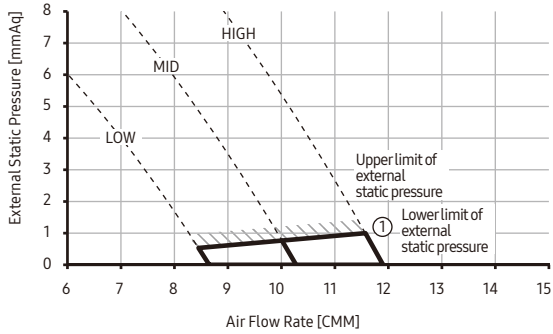

②	External Static Pressure(mmAq)	Option Code
	$1 < SP \leq 3$	010054-1350F8-202424-331110

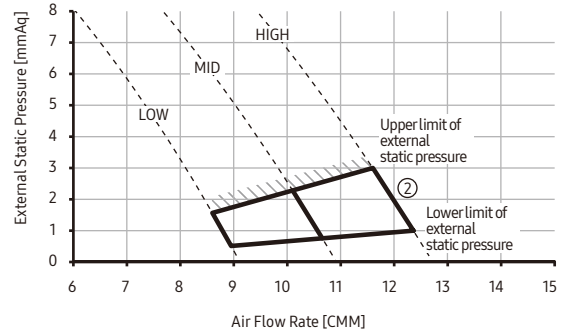

③	External Static Pressure(mmAq)	Option Code
	$3 < SP \leq 5$	010054-13542C-202424-331110

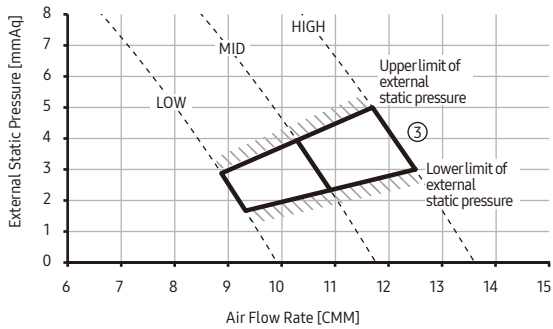

④	External Static Pressure(mmAq)	Option Code
	$5 < SP \leq 6$	010054-1354CF-202424-331110

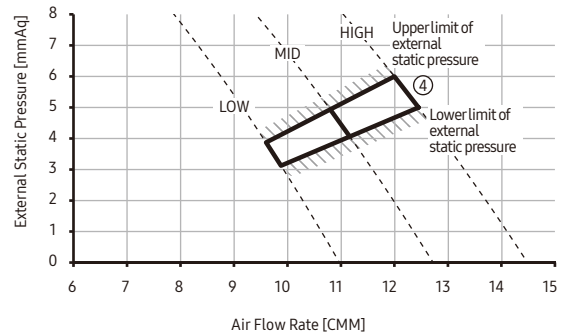

Note

Adjust option code according to the actual installation condition (external static pressure).

ESP = External Static Pressure

The graphs display the available external static pressure range of installed indoor units. Therefore, they do not reflect the actual change of external static pressure and airflow rate according to adjusted airflow (High-Mid-Low) of installed indoor units.

7 Fan Characteristics

MSP Duct

4) AM045*NMDEH/EU

①	External Static Pressure(mmAq)	Option Code
	$0 < SP \leq 1$	010054-125550-202D2D-331110

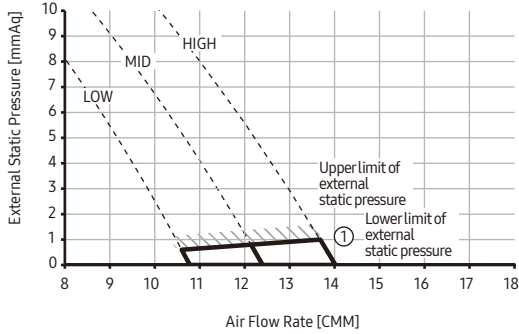

②	External Static Pressure(mmAq)	Option Code
	$1 < SP \leq 3$	010054-125571-202D2D-331110

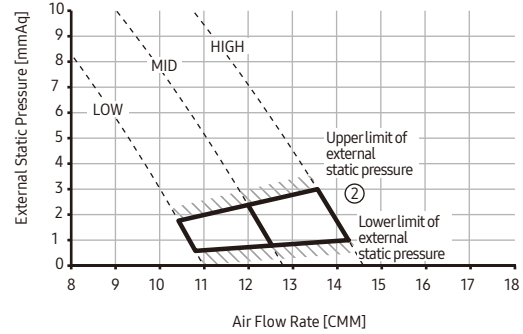

③	External Static Pressure(mmAq)	Option Code
	$3 < SP \leq 5$	010054-125583-202D2D-331110

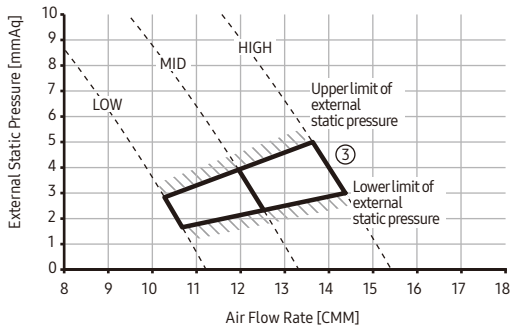

④	External Static Pressure(mmAq)	Option Code
	$5 < SP \leq 7$	010054-1255A4-202D2D-331110

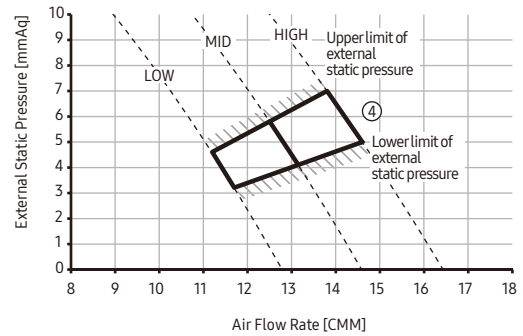

⑤	External Static Pressure(mmAq)	Option Code
	$7 < SP \leq 8$	010054-125906-202D2D-331110

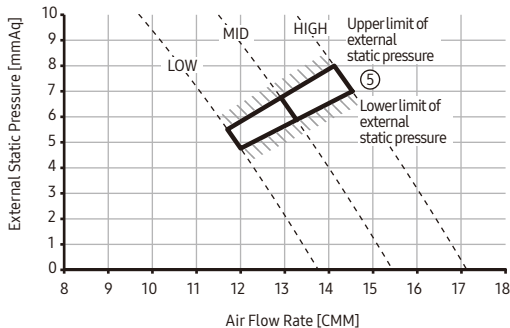

Note

Adjust option code according to the actual installation condition (external static pressure).

ESP = External Static Pressure

The graphs display the available external static pressure range of installed indoor units. Therefore, they do not reflect the actual change of external static pressure and airflow rate according to adjusted airflow (High-Mid-Low) of installed indoor units.

7 Fan Characteristics

MSP Duct

5) AM056*NMDEH/EU

①	External Static Pressure(mmAq)	Option Code
	$0 < SP \leq 1$	010054-125571-203838-331110

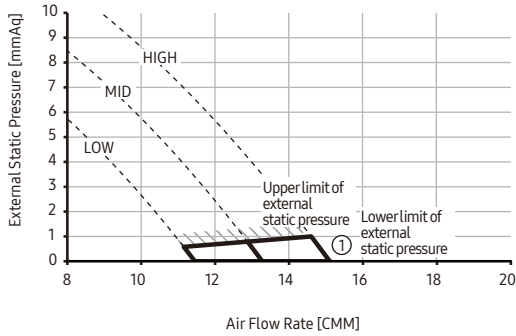

②	External Static Pressure(mmAq)	Option Code
	$1 < SP \leq 3$	010054-125593-203838-331110

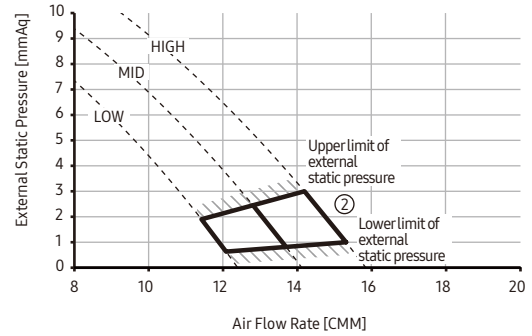

③	External Static Pressure(mmAq)	Option Code
	$3 < SP \leq 5$	010054-1255C5-203838-331110

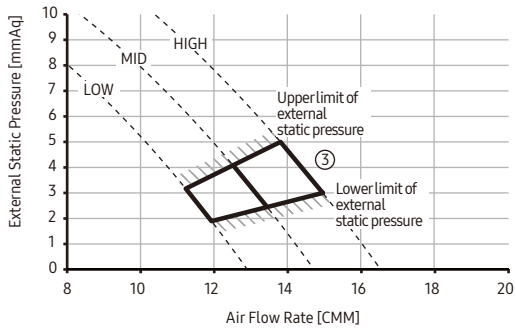

④	External Static Pressure(mmAq)	Option Code
	$5 < SP \leq 7$	010054-1255F5-203838-331110

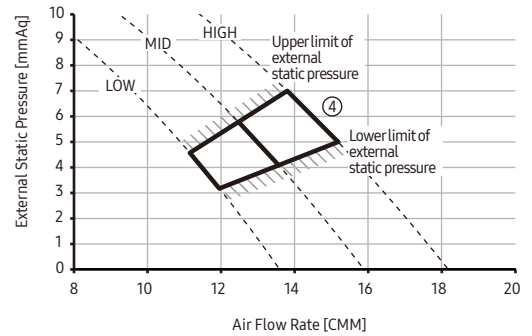

⑤	External Static Pressure(mmAq)	Option Code
	$7 < SP \leq 8$	010054-125957-203838-331110

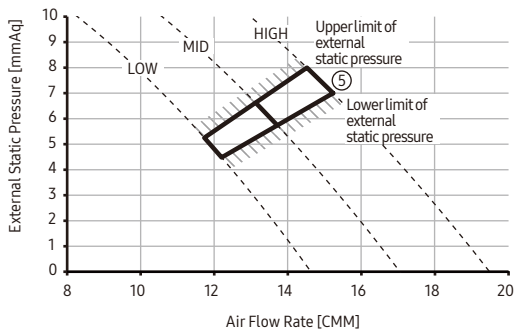

Note

Adjust option code according to the actual installation condition (external static pressure).

ESP = External Static Pressure

The graphs display the available external static pressure range of installed indoor units. Therefore, they do not reflect the actual change of external static pressure and airflow rate according to adjusted airflow (High-Mid-Low) of installed indoor units.

7 Fan Characteristics

MSP Duct

6) AM071*NMDEH/EU

①	External Static Pressure(mmAq)	Option Code
	$0 < SP \leq 1$	010054-125904-204747-331110

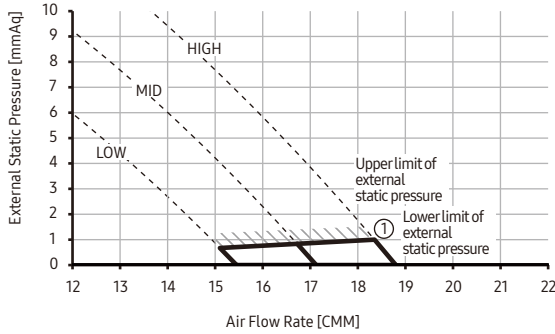

②	External Static Pressure(mmAq)	Option Code
	$1 < SP \leq 3$	010054-125936-204747-331110

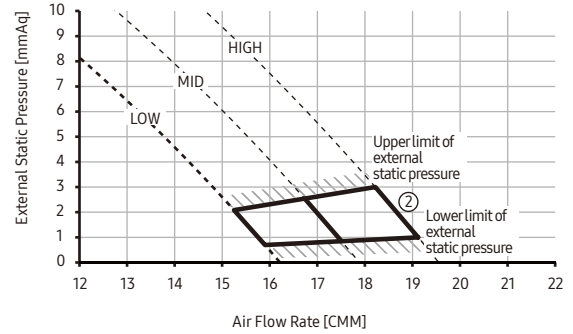

③	External Static Pressure(mmAq)	Option Code
	$3 < SP \leq 5$	010054-125979-204747-331110

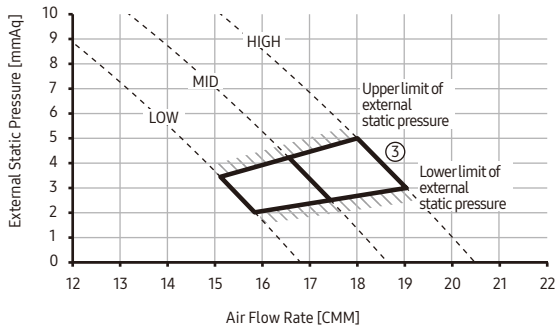

④	External Static Pressure(mmAq)	Option Code
	$5 < SP \leq 7$	010054-125DF9-204747-331110

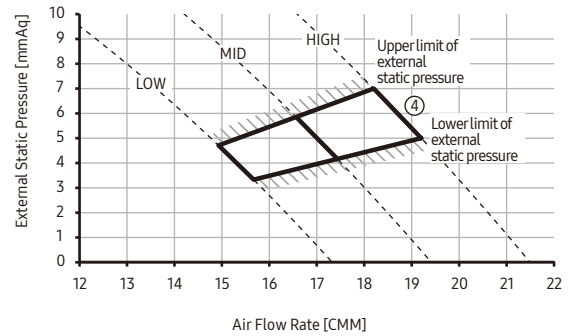

⑤	External Static Pressure(mmAq)	Option Code
	$7 < SP \leq 8$	010054-125DFC-204747-331110

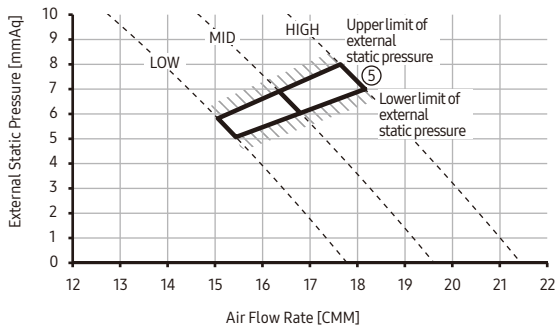

Note

Adjust option code according to the actual installation condition (external static pressure).

ESP = External Static Pressure

The graphs display the available external static pressure range of installed indoor units. Therefore, they do not reflect the actual change of external static pressure and airflow rate according to adjusted airflow (High-Mid-Low) of installed indoor units.

7 Fan Characteristics

MSP Duct

7) AM090*NMDEH/EU

①	External Static Pressure(mmAq)	Option Code
	4 < SP ≤ 5	010054-125945-205A5A-331110

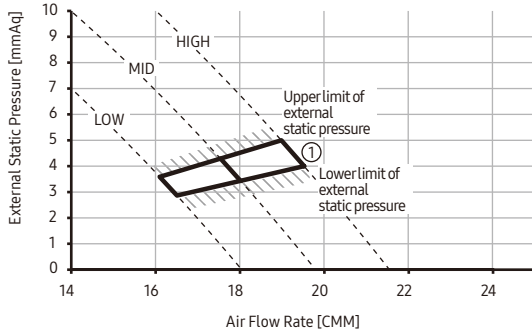

②	External Static Pressure(mmAq)	Option Code
	5 < SP ≤ 7	010054-125D29-205A5A-331110

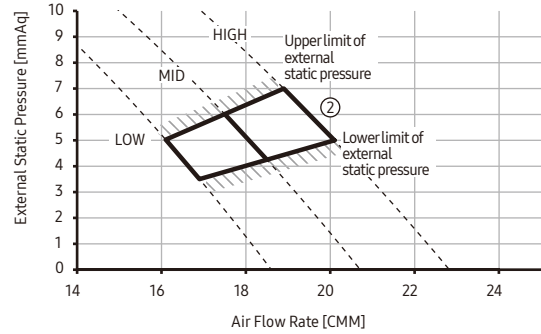

③	External Static Pressure(mmAq)	Option Code
	7 < SP ≤ 8	010054-125DFD-205A5A-331110

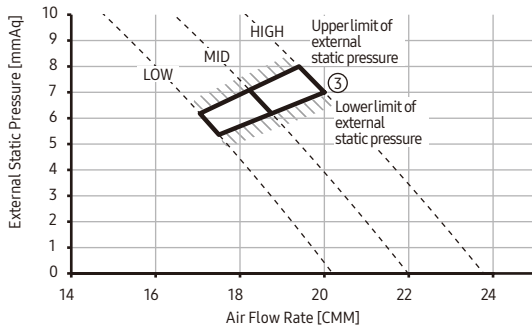

Note

Adjust option code according to the actual installation condition (external static pressure).

ESP = External Static Pressure

The graphs display the available external static pressure range of installed indoor units. Therefore, they do not reflect the actual change of external static pressure and airflow rate according to adjusted airflow (High-Mid-Low) of installed indoor units.

7 Fan Characteristics

MSP Duct

8) AM112*NMDEH/EU

①	External Static Pressure(mmAq)	Option Code
	4 < SP ≤ 6	010054-122E04-207070-331110

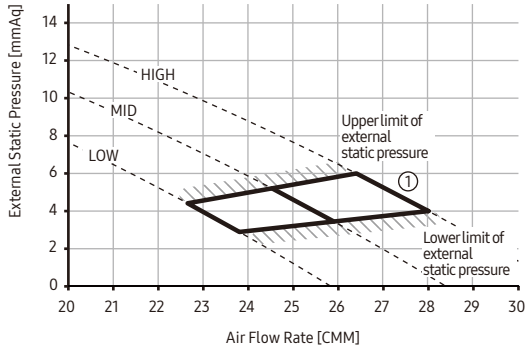

②	External Static Pressure(mmAq)	Option Code
	6 < SP ≤ 7	010054-122E26-207070-331110

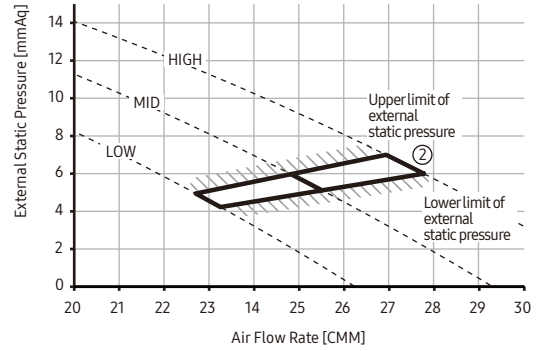

③	External Static Pressure(mmAq)	Option Code
	7 < SP ≤ 9	010054-122EBB-207070-331110

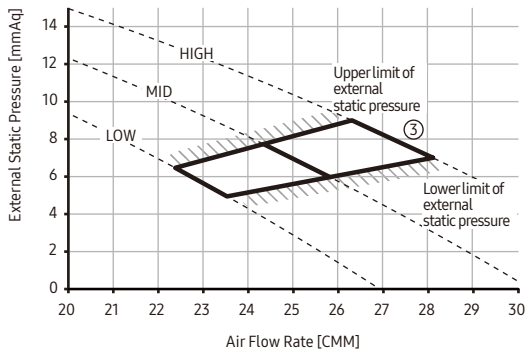

④	External Static Pressure(mmAq)	Option Code
	9 < SP ≤ 12	010054-122FF0-207070-331110

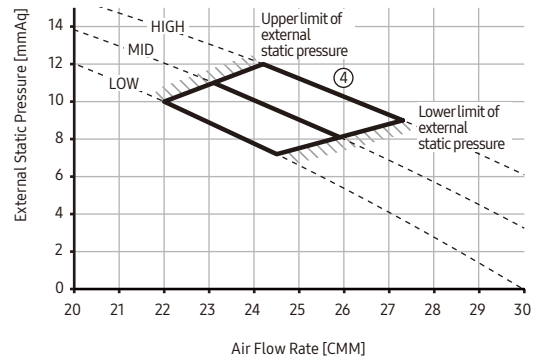

Note

Adjust option code according to the actual installation condition (external static pressure).

ESP = External Static Pressure

The graphs display the available external static pressure range of installed indoor units. Therefore, they do not reflect the actual change of external static pressure and airflow rate according to adjusted airflow (High-Mid-Low) of installed indoor units.

7 Fan Characteristics

MSP Duct

9) AM128*NMDEH/EU

①	External Static Pressure(mmAq)	Option Code
	4 < SP ≤ 6	010054-12296C-208080-331110

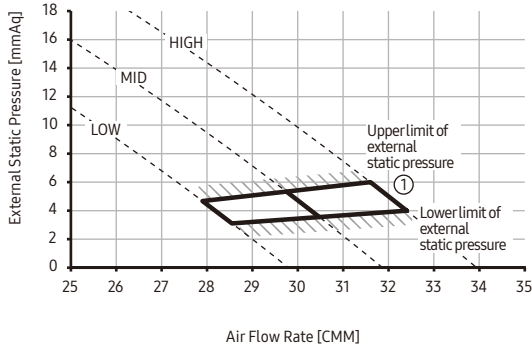

②	External Static Pressure(mmAq)	Option Code
	6 < SP ≤ 7	010054-12299E-208080-331110

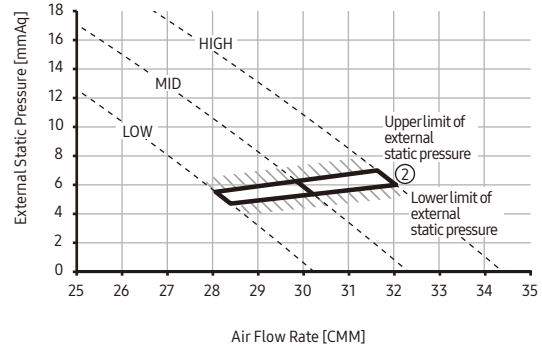

③	External Static Pressure(mmAq)	Option Code
	7 < SP ≤ 9	010054-122A80-208080-331110

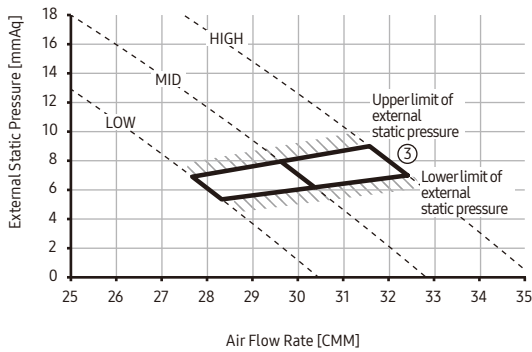

④	External Static Pressure(mmAq)	Option Code
	9 < SP ≤ 11	010054-122AE2-208080-331110

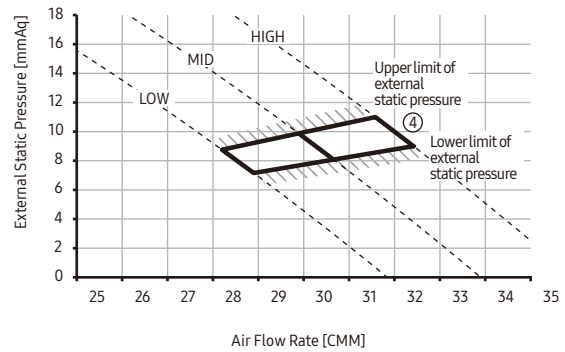

⑤	External Static Pressure(mmAq)	Option Code
	11 < SP ≤ 13	010054-122E14-208080-331110

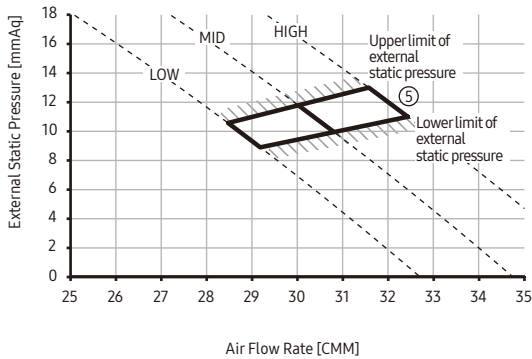

⑥	External Static Pressure(mmAq)	Option Code
	13 < SP ≤ 14	010054-122E36-208080-331110

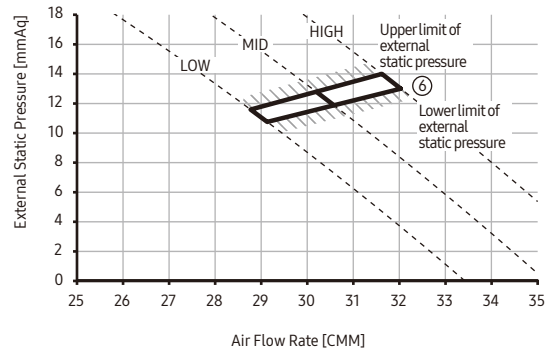

Note

Adjust option code according to the actual installation condition (external static pressure).

ESP = External Static Pressure

The graphs display the available external static pressure range of installed indoor units. Therefore, they do not reflect the actual change of external static pressure and airflow rate according to adjusted airflow (High-Mid-Low) of installed indoor units.

7 Fan Characteristics

MSP Duct

10) AM140*NMDEH/EU

①	External Static Pressure(mmAq)	Option Code
	4 < SP ≤ 6	010054-1229CF-208C8C-331110

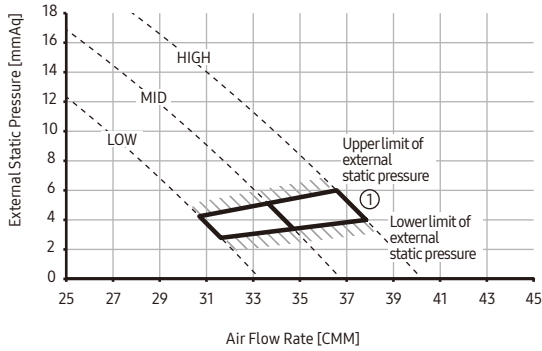

②	External Static Pressure(mmAq)	Option Code
	6 < SP ≤ 7	010054-122AF2-208C8C-331110

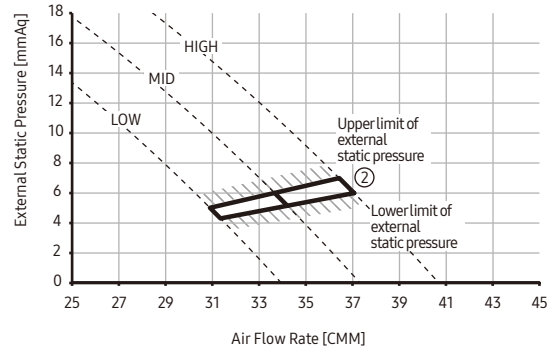

③	External Static Pressure(mmAq)	Option Code
	7 < SP ≤ 9	010054-122E24-208C8C-331110

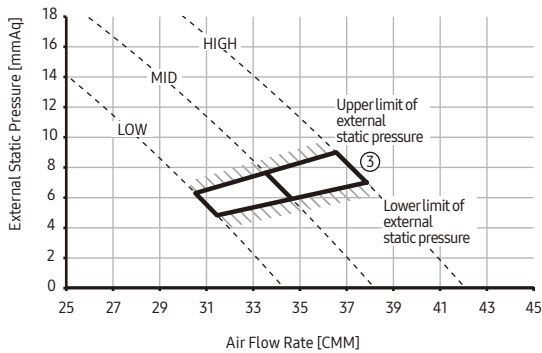

④	External Static Pressure(mmAq)	Option Code
	9 < SP ≤ 11	010054-122E47-208C8C-331110

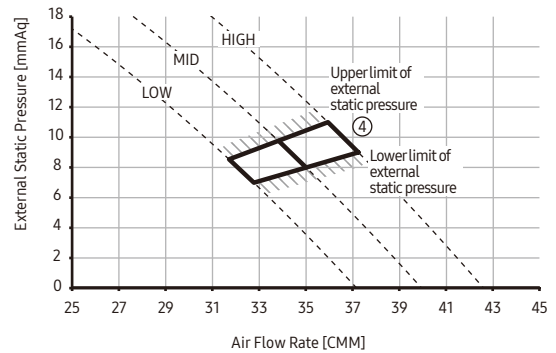

⑤	External Static Pressure(mmAq)	Option Code
	11 < SP ≤ 13	010054-122EAA-208C8C-331110

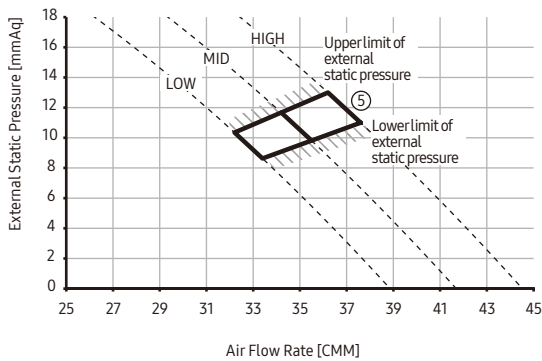

⑥	External Static Pressure(mmAq)	Option Code
	13 < SP ≤ 14	010054-122EFC-208C8C-331110

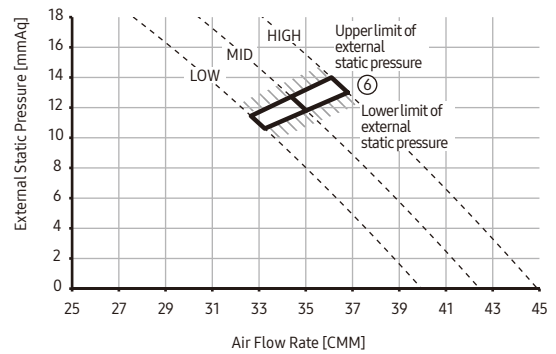

Note

Adjust option code according to the actual installation condition (external static pressure).

ESP = External Static Pressure

The graphs display the available external static pressure range of installed indoor units. Therefore, they do not reflect the actual change of external static pressure and airflow rate according to adjusted airflow (High-Mid-Low) of installed indoor units.

7 Fan Characteristics

MSP Duct

11) AM160KNMDEH*EU

①	External Static Pressure(mmAq)	Option Code
	4 < SP ≤ 6	010054-125E79-20A0A0-331110

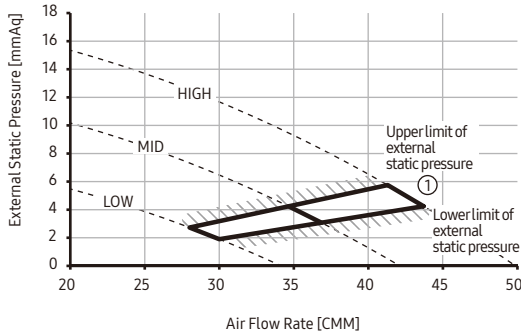

②	External Static Pressure(mmAq)	Option Code
	6 < SP ≤ 7	010054-125EAA-20A0A0-331110

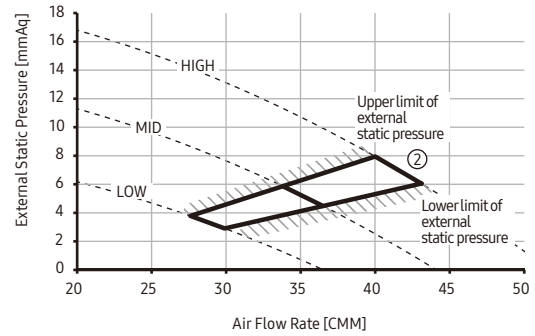

③	External Static Pressure(mmAq)	Option Code
	7 < SP ≤ 9	010054-125EDB-20A0A0-331110

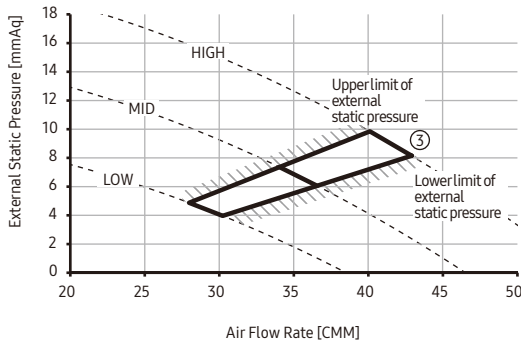

④	External Static Pressure(mmAq)	Option Code
	9 < SP ≤ 11	010054-125EFC-20A0A0-331110

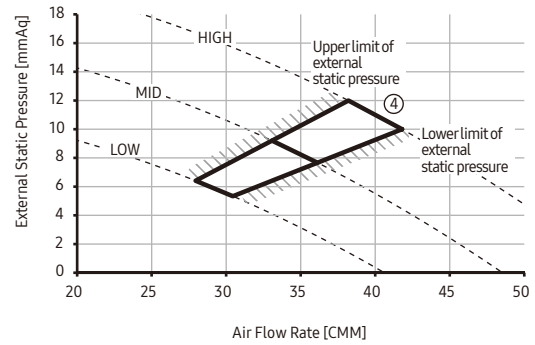

⑤	External Static Pressure(mmAq)	Option Code
	11 < SP ≤ 13	010054-125EFD-20A0A0-331110

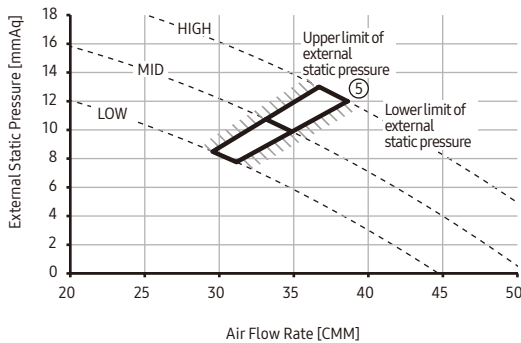

⑥	External Static Pressure(mmAq)	Option Code
	13 < SP ≤ 14	010054-125EFE-20A0A0-331110

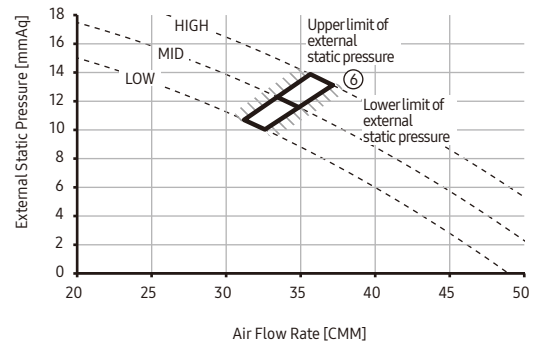

Note

Adjust option code according to the actual installation condition (external static pressure).

ESP = External Static Pressure

The graphs display the available external static pressure range of installed indoor units. Therefore, they do not reflect the actual change of external static pressure and airflow rate according to adjusted airflow (High-Mid-Low) of installed indoor units.

HSP Duct

- 1 *Specifications*
- 2 *Capacity Table*
- 3 *Dimensional Drawing*
- 4 *Electrical Wiring Diagram*
- 5 *Sound Pressure Level*
- 6 *Fan Characteristics*

1 Specifications

HSP Duct

1) Technical specifications

Model				AM112FNHDEH***	AM128FNHDEH***	AM140FNHDEH***	AM220FNHDEH***	AM280FNHDEH***
Power Supply			∅, #, V, Hz	1, 2, 220~240, 50	1, 2, 220~240, 50	1, 2, 220~240, 50	1, 2, 220~240, 50	1, 2, 220~240, 50
Mode*1)				HP / HR	HP / HR	HP / HR	HP/HR	HP/HR
Performance	Capacity (Nominal)	Cooling ²⁾	kW	11.2	12.8	14.0	22.4	28.0
			Btu/h	38,200	43,700	47,800	76,400	95,500
		Heating ³⁾	kW	12.5	13.8	16.0	25.0	31.5
			Btu/h	42,700	47,100	57,300	85,300	107,500
Power	Power Input (Nominal)	Cooling ²⁾	W	305	333	385	530	790
			Heating ³⁾	305	333	385	530	790
	Current Input (Nominal)	Cooling ²⁾	A	3.6	3.75	3.9	3.8	5.9
			Heating ³⁾	3.6	3.75	3.9	3.8	5.9
Fan	Motor	Type	-	Sirocco Fan / AC	Sirocco Fan / AC	Sirocco Fan / AC	Sirocco Fan	Sirocco Fan
		Output	W	-	-	-	400	400
		Number of unit	EA	2	2	2	1	1
	Air Flow Rate	H/M/L (UL)	CMM	32 / 27 / 23	35 / 31 / 26	39 / 33 / 28	58.00/52.00/47.00	72.00/65.00/58.00
			l/s	533.33/450.00/383.33	583.33/516.67/466.67	650.00/550.00/466.67	966.67/866.67/783.33	1,200.00/1,083.33/966.67
	External Pressure	Min / Std / Max	mmAq	5 / 10 / 20	5 / 10 / 20	5 / 10 / 20	5.00/15.00/25.00	5.00/15.00/28.00
			Pa	49 / 98.1 / 196.1	49 / 98.1 / 196.1	49 / 98.1 / 196.1	49.03/147.10/245.17	49.03/147.10/274.59
		WG	-	-	-	-	-	
Option Code			-	010054-13598F-207070-331110	010054-135AC4-207070-331110	010054-135E09-207C7C-331110	011054-1950E8-20DCDC-331110	011054-19545B-231C1C-331110
Piping Connections	Liquid Pipe	∅, mm	9.52	9.52	9.52	9.52	9.52	
		∅, inch	3/8	3/8	3/8	3/8	3/8	
	Gas Pipe	∅, mm	15.88	15.88	15.88	19.05	22.23	
		∅, inch	5/8	5/8	5/8	3/4	7/8	
	Drain Pipe	∅, mm	VP25 (OD 32, ID 25)	VP25 (OD 32, ID 25)	VP25 (OD 32, ID 25)	VP25 (OD 32, ID 25)	VP25 (OD 32, ID 25)	
Field Wiring	Power Source Wire	Below 20m / over 20m	mm ²	1.5 / 2.5	1.5 / 2.5	1.5 / 2.5	1.5 / 2.5	1.5 / 2.5
	Transmission Cable		mm ²	0.75~1.5	0.75~1.5	0.75~1.5	0.75~1.5	0.75~1.5
Refrigerant	Type		-	R410A	R410A	R410A	R410A	R410A
	Control Method		-	EEV	EEV	EEV	EEV INCLUDED	EEV INCLUDED
Sound	Sound Pressure	High / Mid / Low ⁴⁾	dBA	43 / 41 / 39	45 / 43 / 42	46 / 45 / 44	45 / 43 / 41	48 / 46 / 43
Dimensions	Net Weight		kg	57.0	57.0	57.0	89.0	89.0
	Shipping Weight		kg	64.0	64.0	64.0	99.0	99.0
	Net Dimensions (W×H×D)		mm	1,200 x 360 x 650	1,200 x 360 x 650	1,200 x 360 x 650	1240 x 470 x 1040	1240 x 470 x 1040
	Shipping Dimensions (W×H×D)		mm	1,447 x 425 x 769	1,447 x 425 x 769	1,447 x 425 x 769	1507 x 558 x 1155	1507 x 558 x 1155
Panel Size	Panel model		-	-	-	-	-	-
	Panel Net Weight		kg	-	-	-	-	-
	Shipping Weight		kg	-	-	-	-	-
	Net Dimensions (W×H×D)		mm	-	-	-	-	-
	Shipping Dimensions (W×H×D)		mm	-	-	-	-	-
Additional Accessories	Drain pump	Drain pump	- / Model	Optional / MDP-M075SGU2	Optional / MDP-M075SGU2	Optional / MDP-M075SGU2	MDP-N047SNC1D	MDP-N047SNC1D
		Max. lifting Height / Displacement	mm/liter/h	750 / 24	750 / 24	750 / 24	750 / 24	750 / 24
	Air Filter			-	Long life filter	Long life filter	Long life filter	-

*Specifications may be subject to change without prior notice for product improvement.

*1) Mode

- HP : Heat Pump, HR : Heat Recovery

*2) Nominal cooling capacities are based on:

- Indoor temperature : 27°C DB, 19°C WB

- Outdoor temperature : 35°C DB, 24°C WB, Equivalent refrigerant piping : 7.5m, Level differences : 0m

*3) Nominal heating capacities are based on:

- Indoor temperature : 20°C DB, 15°C WB

- Outdoor temperature : 7°C DB, 6°C WB, Equivalent refrigerant piping : 7.5m, Level differences : 0m

*4) Sound pressure was acquired in an anechoic room. Thus actual noise level may be different depending on the installation conditions.

*5) These products contain R410A which is fluorinated greenhouse gas.

* Heat Exchanger type : Fin & Tube (Fin : Al, Tube : Cu)

2 Capacity table

HSP Duct

1) Cooling

TC : Total Capacity(kW), SHC : Sensible Heat Capacity(kW)

Capacity Index	Outdoor Air Temp. (°C,DB)	Indoor temperature													
		20(°C,DB)		23(°C,DB)		26(°C,DB)		27(°C,DB)		28(°C,DB)		30(°C,DB)		32(°C,DB)	
		14(°C,WB)		16(°C,WB)		18(°C,WB)		19(°C,WB)		20(°C,WB)		22(°C,WB)		24(°C,WB)	
		TC	SHC	TC	SHC	TC	SHC	TC	SHC	TC	SHC	TC	SHC	TC	SHC
112	10	7.7	6.8	9.1	7.7	10.5	8.2	11.2	8.6	11.6	8.8	12.5	8.9	13.4	8.6
	12	7.7	6.8	9.1	7.7	10.5	8.2	11.2	8.6	11.6	8.8	12.5	8.9	13.4	8.6
	14	7.7	6.8	9.1	7.7	10.5	8.2	11.2	8.6	11.6	8.8	12.5	8.9	13.4	8.6
	16	7.7	6.8	9.1	7.7	10.5	8.2	11.2	8.6	11.6	8.8	12.5	8.9	13.3	8.5
	18	7.7	6.8	9.1	7.7	10.5	8.2	11.2	8.6	11.6	8.8	12.5	8.9	13.3	8.5
	20	7.7	6.8	9.1	7.7	10.5	8.2	11.2	8.6	11.6	8.8	12.4	8.8	13.2	8.5
	21	7.7	6.8	9.1	7.7	10.5	8.2	11.2	8.6	11.6	8.8	12.4	8.8	13.2	8.5
	23	7.7	6.8	9.1	7.7	10.5	8.2	11.2	8.6	11.6	8.8	12.4	8.8	13.2	8.5
	25	7.7	6.8	9.1	7.7	10.5	8.2	11.2	8.6	11.6	8.8	12.4	8.8	13.2	8.5
	27	7.7	6.8	9.1	7.7	10.5	8.2	11.2	8.6	11.6	8.8	12.4	8.8	13.2	8.5
	29	7.7	6.8	9.1	7.7	10.5	8.2	11.2	8.6	11.6	8.8	12.4	8.8	13.2	8.5
	31	7.7	6.8	9.1	7.7	10.5	8.2	11.2	8.6	11.6	8.8	12.4	8.8	13.2	8.5
	33	7.7	6.8	9.1	7.7	10.5	8.2	11.2	8.6	11.6	8.8	12.4	8.8	13.2	8.5
	35	7.7	6.8	9.1	7.7	10.5	8.2	11.2	8.6	11.6	8.8	12.4	8.7	13.2	8.5
	37	7.7	6.8	9.1	7.7	10.5	8.2	11.2	8.6	11.6	8.8	12.4	8.9	13.2	8.5
	39	7.7	6.8	9.1	7.7	10.5	8.2	11.2	8.6	11.6	8.8	12.3	8.8	13.0	8.4
42	7.7	6.8	9.1	7.7	10.4	8.1	11.1	8.5	11.5	8.7	12.1	8.6	12.7	8.2	
44	7.7	6.8	9.1	7.7	10.1	7.9	10.7	8.2	11.1	8.4	11.6	8.3	12.2	7.9	
46	7.7	6.8	9.0	7.6	10.0	7.8	10.4	8.0	10.8	8.2	11.2	8.0	11.9	7.7	
48	7.6	6.7	8.9	7.5	9.8	7.7	10.1	7.7	10.6	8.0	10.9	7.8	11.5	7.4	
128	10	8.8	7.8	10.4	8.9	12.0	9.5	12.8	9.9	13.3	9.9	14.3	10.0	15.4	9.9
	12	8.8	7.8	10.4	8.9	12.0	9.5	12.8	9.9	13.3	9.9	14.3	10.0	15.3	9.8
	14	8.8	7.8	10.4	8.9	12.0	9.5	12.8	9.9	13.3	9.9	14.3	10.0	15.3	9.8
	16	8.8	7.8	10.4	8.9	12.0	9.5	12.8	9.9	13.3	9.9	14.2	9.9	15.2	9.8
	18	8.8	7.8	10.4	8.9	12.0	9.5	12.8	9.9	13.3	9.9	14.2	9.9	15.1	9.7
	20	8.8	7.8	10.4	8.9	12.0	9.5	12.8	9.9	13.3	9.9	14.2	9.9	15.1	9.7
	21	8.8	7.8	10.4	8.9	12.0	9.5	12.8	9.9	13.3	9.9	14.2	9.9	15.1	9.7
	23	8.8	7.8	10.4	8.9	12.0	9.5	12.8	9.9	13.3	9.9	14.2	9.9	15.1	9.7
	25	8.8	7.8	10.4	8.9	12.0	9.5	12.8	9.9	13.3	9.9	14.2	9.9	15.1	9.7
	27	8.8	7.8	10.4	8.9	12.0	9.5	12.8	9.9	13.3	9.9	14.2	9.9	15.1	9.7
	29	8.8	7.8	10.4	8.9	12.0	9.5	12.8	9.9	13.3	9.9	14.2	9.9	15.1	9.7
	31	8.8	7.8	10.4	8.9	12.0	9.5	12.8	9.9	13.3	9.9	14.2	9.9	15.1	9.7
	33	8.8	7.8	10.4	8.9	12.0	9.5	12.8	9.9	13.3	9.9	14.2	9.9	15.1	9.7
	35	8.8	7.8	10.4	8.9	12.0	9.5	12.8	9.9	13.3	9.9	14.2	9.9	15.1	9.7
	37	8.8	7.8	10.4	8.9	12.0	9.5	12.8	9.9	13.2	9.9	14.0	9.8	14.9	9.6
	39	8.8	7.8	10.4	8.9	12.0	9.5	12.8	9.9	13.1	9.8	13.8	9.6	14.5	9.4
42	8.8	7.8	10.4	8.9	11.9	9.4	12.6	9.8	12.9	9.7	13.6	9.4	14.1	9.2	
44	8.8	7.8	10.4	8.9	11.6	9.2	12.2	9.5	12.6	9.4	13.0	9.1	13.6	8.8	
46	8.8	7.8	10.3	8.8	11.4	9.0	11.8	9.2	12.2	9.1	12.6	8.8	13.3	8.6	
48	8.7	7.7	10.2	8.7	11.2	8.9	11.5	8.9	12.0	8.9	12.2	8.5	12.8	8.3	
140	10	9.7	8.6	11.4	9.7	13.1	10.5	14.0	10.8	14.6	10.9	15.7	11.0	16.8	10.9
	12	9.7	8.6	11.4	9.7	13.1	10.5	14.0	10.8	14.5	10.8	15.6	10.9	16.7	10.8
	14	9.7	8.6	11.4	9.7	13.1	10.5	14.0	10.8	14.5	10.8	15.6	10.9	16.7	10.8
	16	9.7	8.6	11.4	9.7	13.1	10.5	14.0	10.8	14.5	10.8	15.6	10.9	16.6	10.7
	18	9.7	8.6	11.4	9.7	13.1	10.5	14.0	10.8	14.5	10.8	15.5	10.8	16.6	10.7
	20	9.7	8.6	11.4	9.7	13.1	10.5	14.0	10.8	14.5	10.8	15.5	10.8	16.5	10.6
	21	9.7	8.6	11.4	9.7	13.1	10.5	14.0	10.8	14.5	10.8	15.5	10.8	16.5	10.6
	23	9.7	8.6	11.4	9.7	13.1	10.5	14.0	10.8	14.5	10.8	15.5	10.8	16.5	10.6
	25	9.7	8.6	11.4	9.7	13.1	10.5	14.0	10.8	14.5	10.8	15.5	10.8	16.5	10.6
	27	9.7	8.6	11.4	9.7	13.1	10.5	14.0	10.8	14.5	10.8	15.5	10.8	16.5	10.6
	29	9.7	8.6	11.4	9.7	13.1	10.5	14.0	10.8	14.5	10.8	15.5	10.8	16.5	10.6
	31	9.7	8.6	11.4	9.7	13.1	10.5	14.0	10.8	14.5	10.8	15.5	10.8	16.5	10.6
	33	9.7	8.6	11.4	9.7	13.1	10.5	14.0	10.8	14.5	10.8	15.5	10.8	16.5	10.6
	35	9.7	8.6	11.4	9.7	13.1	10.5	14.0	10.8	14.5	10.8	15.5	10.8	16.5	10.6
	37	9.7	8.6	11.4	9.7	13.1	10.5	14.0	10.8	14.5	10.8	15.4	10.7	16.3	10.5
	39	9.7	8.6	11.4	9.7	13.1	10.5	14.0	10.8	14.4	10.7	15.1	10.5	15.9	10.3
42	9.7	8.6	11.4	9.7	13.0	10.4	13.8	10.7	14.2	10.6	14.8	10.3	15.5	10.0	
44	9.7	8.6	11.4	9.7	12.7	10.1	13.4	10.3	13.8	10.3	14.2	9.9	15.0	9.7	
46	9.7	8.6	11.3	9.6	12.4	10.0	12.9	10.0	13.4	10.0	13.8	9.6	14.6	9.4	
48	9.6	8.5	11.1	9.5	12.2	9.8	12.6	9.7	13.1	9.8	13.4	9.3	14.1	9.1	

2 Capacity table

HSP Duct

1) Cooling

TC : Total Capacity(kW), SHC : Sensible Heat Capacity(kW)

Capacity Index	Outdoor Air Temp. (°C, DB)	Indoor temperature													
		20(°C, DB)		23(°C, DB)		26(°C, DB)		27(°C, DB)		28(°C, DB)		30(°C, DB)		32(°C, DB)	
		14(°C, WB)		16(°C, WB)		18(°C, WB)		19(°C, WB)		20(°C, WB)		22(°C, WB)		24(°C, WB)	
		TC	SHC	TC	SHC	TC	SHC	TC	SHC	TC	SHC	TC	SHC	TC	SHC
220	10	15.8	13.8	18.7	15.4	21.2	16.6	22.4	17.1	23.9	17.7	26.4	18.1	27.9	18.3
	12	15.8	13.8	18.7	15.4	21.2	16.6	22.4	17.1	23.9	17.8	26.4	18.2	27.9	18.4
	14	15.8	13.8	18.7	15.4	21.2	16.6	22.4	17.1	23.9	17.8	26.4	18.2	27.9	18.1
	16	15.8	13.8	18.7	15.4	21.2	16.6	22.4	17.1	23.9	17.8	26.4	18.2	27.9	18.3
	18	15.8	13.8	18.7	15.4	21.2	16.6	22.4	17.1	23.9	17.8	26.4	18.2	27.8	18.1
	20	15.8	13.8	18.7	15.4	21.2	16.6	22.4	17.1	23.9	17.8	26.4	18.2	27.4	18.0
	21	15.8	13.8	18.7	15.4	21.2	16.6	22.4	17.1	23.9	17.8	26.4	18.2	27.5	18.0
	23	15.8	13.8	18.7	15.4	21.2	16.6	22.4	17.1	23.9	17.8	26.4	18.3	27.1	17.7
	25	15.8	13.8	18.7	15.4	21.2	16.6	22.4	17.1	23.9	17.8	26.4	18.2	27.0	17.8
	27	15.8	13.8	18.7	15.4	21.2	16.6	22.4	17.1	23.9	17.8	26.4	18.2	27.0	17.8
	29	15.8	13.8	18.7	15.4	21.2	16.6	22.4	17.1	23.9	17.8	26.4	18.2	27.0	17.8
	31	15.8	13.8	18.7	15.4	21.2	16.6	22.4	17.1	23.9	17.8	26.4	18.3	27.0	17.8
	33	15.8	13.8	18.7	15.4	21.2	16.6	22.4	17.1	23.9	17.8	26.4	18.5	27.0	17.8
	35	15.8	13.8	18.7	15.4	21.2	16.6	22.4	17.1	23.9	17.7	26.4	18.5	27.0	18.0
	37	15.5	13.6	18.4	15.2	21.1	16.5	22.4	17.1	23.7	17.7	26.0	18.2	26.6	17.6
	39	15.3	13.5	18.1	15.0	21.1	16.5	22.3	17.0	23.7	17.7	25.7	18.4	26.2	17.5
42	15.3	13.5	18.1	15.0	20.9	16.4	22.0	16.8	23.4	17.5	25.3	18.1	25.5	17.1	
44	15.3	13.5	18.1	15.0	20.4	15.9	21.3	16.2	22.8	17.0	24.2	17.4	24.7	16.5	
46	15.3	13.5	17.9	14.9	20.0	15.7	20.6	15.7	22.1	16.5	23.5	16.8	24.0	16.0	
48	15.1	13.3	17.7	14.7	19.7	15.4	20.1	15.3	21.6	16.2	22.8	16.3	23.2	15.5	
280	10	19.7	17.6	23.3	19.6	26.5	21.2	28.0	21.8	29.9	22.6	32.7	23.0	34.7	23.2
	12	19.7	17.6	23.3	19.6	26.5	21.2	28.0	21.8	29.9	22.8	32.7	23.1	34.7	23.4
	14	19.7	17.6	23.3	19.6	26.5	21.2	28.0	21.8	29.9	22.8	32.7	23.1	34.7	23.0
	16	19.7	17.6	23.3	19.6	26.5	21.2	28.0	21.8	29.9	22.8	32.7	23.1	34.7	23.3
	18	19.7	17.6	23.3	19.6	26.5	21.2	28.0	21.8	29.9	22.8	32.7	23.0	34.7	23.1
	20	19.7	17.6	23.3	19.6	26.5	21.2	28.0	21.8	29.9	22.8	32.7	23.0	34.3	23.0
	21	19.7	17.6	23.3	19.6	26.5	21.2	28.0	21.8	29.9	22.8	32.7	23.0	34.3	22.9
	23	19.7	17.6	23.3	19.6	26.5	21.2	28.0	21.8	29.9	22.8	32.7	23.2	33.7	22.6
	25	19.7	17.6	23.3	19.6	26.5	21.2	28.0	21.8	29.9	22.8	32.7	23.0	33.7	22.8
	27	19.7	17.6	23.3	19.6	26.5	21.2	28.0	21.8	29.9	22.8	32.7	23.0	33.7	22.8
	29	19.7	17.6	23.3	19.6	26.5	21.2	28.0	21.8	29.9	22.8	32.7	23.0	33.7	22.8
	31	19.7	17.6	23.3	19.6	26.5	21.2	28.0	21.8	29.9	22.8	32.7	23.2	33.7	22.8
	33	19.7	17.6	23.3	19.6	26.5	21.2	28.0	21.8	29.9	22.8	32.7	23.5	33.7	22.8
	35	19.7	17.6	23.3	19.6	26.5	21.2	28.0	21.8	29.9	22.6	32.7	23.5	33.7	23.0
	37	19.4	17.3	23.0	19.3	26.3	20.9	28.0	21.8	29.7	22.7	32.2	23.1	33.2	22.5
	39	19.2	17.1	22.7	19.1	26.3	20.9	27.9	21.6	29.5	22.5	31.8	23.4	32.8	22.4
42	19.2	17.1	22.7	19.1	26.1	20.7	27.5	21.3	29.2	22.2	31.2	23.0	32.0	21.8	
44	19.2	17.1	22.7	19.1	25.4	20.2	26.6	20.6	28.3	21.6	30.0	22.1	30.9	21.1	
46	19.2	17.1	22.5	18.9	25.0	19.9	25.8	20.0	27.5	21.0	29.0	21.4	30.0	20.5	
48	19.0	16.9	22.2	18.7	24.6	19.5	25.1	19.4	26.9	20.5	28.2	20.8	29.0	19.8	

2 Capacity table

HSP Duct

2) Heating

TC : Total Capacity(kW)

Capacity Index	Outdoor Air Temp. (°C)		Indoor temperature (°C,DB)				
			16(°C,DB)	18(°C,DB)	20(°C,DB)	22(°C,DB)	24(°C,DB)
	DB	WB	TC kW	TC kW	TC kW	TC kW	TC kW
112	-19.8	-20.0	7.4	7.4	7.3	7.3	7.3
	-18.8	-19.0	7.6	7.6	7.4	7.4	7.3
	-16.7	-17.0	8.1	7.8	7.6	7.5	7.4
	-14.7	-15.0	8.4	8.2	8.0	7.8	7.6
	-12.6	-13.0	8.7	8.5	8.3	8.1	8.0
	-10.5	-11.0	9.1	8.9	8.8	8.7	8.6
	-9.5	-10.0	9.3	9.1	9.0	8.9	8.8
	-8.5	-9.1	9.5	9.3	9.2	9.0	8.9
	-7.0	-7.6	9.7	9.6	9.4	9.2	9.0
	-5.0	-5.6	10.2	10.1	9.9	9.6	9.3
	-3.0	-3.7	10.7	10.6	10.5	10.1	9.7
	0.0	-0.7	11.3	11.1	11.1	10.5	10.0
	3.0	2.2	11.8	11.6	11.5	11.0	10.6
	5.0	4.1	12.3	12.2	12.0	11.3	10.6
	7.0	6.0	12.9	12.7	12.5	11.5	10.6
9.0	7.9	13.3	12.9	12.5	11.5	10.6	
11.0	9.8	13.7	13.1	12.5	11.5	10.6	
13.0	11.8	14.0	13.3	12.5	11.5	10.6	
15.0	13.7	14.4	13.5	12.5	11.5	10.6	
128	-19.8	-20.0	8.1	8.1	8.0	8.0	8.0
	-18.8	-19.0	8.3	8.3	8.2	8.1	8.0
	-16.7	-17.0	8.8	8.6	8.4	8.3	8.1
	-14.7	-15.0	9.3	9.1	8.8	8.6	8.3
	-12.6	-13.0	9.6	9.4	9.2	9.0	8.8
	-10.5	-11.0	10.0	9.9	9.8	9.6	9.4
	-9.5	-10.0	10.2	10.1	10.0	9.8	9.7
	-8.5	-9.1	10.4	10.3	10.2	10.0	9.8
	-7.0	-7.6	10.7	10.6	10.4	10.2	10.0
	-5.0	-5.6	11.3	11.1	11.0	10.7	10.3
	-3.0	-3.7	11.9	11.7	11.5	11.1	10.7
	0.0	-0.7	12.4	12.3	12.1	11.6	11.0
	3.0	2.2	13.0	12.9	12.7	12.2	11.7
	5.0	4.1	13.6	13.4	13.2	12.4	11.7
	7.0	6.0	14.2	14.0	13.8	12.7	11.7
9.0	7.9	14.6	14.2	13.8	12.7	11.7	
11.0	9.8	15.1	14.4	13.8	12.7	11.7	
13.0	11.8	15.5	14.7	13.8	12.7	11.7	
15.0	13.7	15.9	14.9	13.8	12.7	11.7	
140	-19.8	-20.0	9.5	9.5	9.4	9.4	9.3
	-18.8	-19.0	9.7	9.7	9.5	9.5	9.3
	-16.7	-17.0	10.2	10.0	9.7	9.6	9.4
	-14.7	-15.0	10.8	10.5	10.2	9.9	9.6
	-12.6	-13.0	11.1	10.9	10.7	10.4	10.1
	-10.5	-11.0	11.6	11.5	11.3	11.1	10.9
	-9.5	-10.0	11.8	11.7	11.5	11.4	11.2
	-8.5	-9.1	12.1	11.9	11.8	11.6	11.3
	-7.0	-7.6	12.4	12.2	12.1	11.8	11.5
	-5.0	-5.6	13.1	12.9	12.7	12.3	12.0
	-3.0	-3.7	13.8	13.6	13.4	12.9	12.4
	0.0	-0.7	14.4	14.2	14.0	13.4	12.8
	3.0	2.2	15.1	14.9	14.7	14.1	13.5
	5.0	4.1	15.8	15.6	15.3	14.4	13.5
	7.0	6.0	16.5	16.2	16.0	14.8	13.5
9.0	7.9	17.0	16.5	16.0	14.8	13.5	
11.0	9.8	17.5	16.7	16.0	14.8	13.5	
13.0	11.8	18.0	17.0	16.0	14.8	13.5	
15.0	13.7	18.5	17.2	16.0	14.8	13.5	

2 Capacity table

HSP Duct

2) Heating

TC : Total Capacity(kW)

Capacity Index	Outdoor Air Temp. (°C)		Indoor temperature (°C,DB)				
			16(°C,DB)	18(°C,DB)	20(°C,DB)	22(°C,DB)	24(°C,DB)
	DB	WB	TC kW	TC kW	TC kW	TC kW	TC kW
220	-19.8	-20.0	20.3	19.5	18.4	17.6	16.9
	-18.8	-19.0	20.5	19.7	18.6	17.9	17.4
	-16.7	-17.0	20.9	20.1	19.0	18.5	18.3
	-14.7	-15.0	21.7	20.8	19.7	19.2	18.9
	-12.6	-13.0	22.7	21.8	20.6	20.0	19.8
	-10.5	-11.0	24.3	23.3	22.0	21.1	20.8
	-9.5	-10.0	24.8	23.8	22.5	21.6	21.3
	-8.5	-9.1	25.1	24.1	22.7	21.9	21.6
	-7.0	-7.6	25.4	24.4	23.0	22.3	22.0
	-5.0	-5.6	26.2	25.2	23.7	23.2	22.6
	-3.0	-3.7	26.8	25.8	24.3	24.1	23.1
	0.0	-0.7	27.4	26.5	24.9	24.3	23.7
	3.0	2.2	28.0	27.0	25.0	24.4	23.6
	5.0	4.1	28.3	27.0	25.0	24.4	23.6
	7.0	6.0	28.8	27.0	25.0	24.4	23.6
9.0	7.9	28.8	27.0	25.0	24.4	23.6	
11.0	9.8	28.8	27.0	25.0	24.4	23.6	
13.0	11.8	28.8	27.0	25.0	24.4	23.6	
15.0	13.7	28.8	27.0	25.0	24.4	23.6	
280	-19.8	-20.0	25.4	24.4	23.0	22.0	21.1
	-18.8	-19.0	25.6	24.6	23.2	22.3	21.6
	-16.7	-17.0	26.2	25.1	23.7	23.0	22.6
	-14.7	-15.0	27.2	26.1	24.7	23.9	23.5
	-12.6	-13.0	28.4	27.3	25.8	24.9	24.5
	-10.5	-11.0	30.4	29.2	27.5	26.4	26.0
	-9.5	-10.0	31.1	29.8	28.1	27.0	26.6
	-8.5	-9.1	31.4	30.1	28.4	27.4	26.9
	-7.0	-7.6	31.8	30.5	28.8	27.9	27.3
	-5.0	-5.6	32.7	31.5	29.7	29.0	28.1
	-3.0	-3.7	33.5	32.2	30.4	29.8	28.7
	0.0	-0.7	34.3	33.1	31.1	30.4	29.3
	3.0	2.2	35.0	33.7	31.5	30.4	29.5
	5.0	4.1	35.3	33.7	31.5	30.4	29.5
	7.0	6.0	35.7	33.7	31.5	30.4	29.5
9.0	7.9	35.7	33.7	31.5	30.4	29.5	
11.0	9.8	35.7	33.7	31.5	30.4	29.5	
13.0	11.8	35.7	33.7	31.5	30.4	29.5	
15.0	13.7	35.7	33.7	31.5	30.4	29.5	

3 Dimensional drawing

HSP Duct

1) AM112/128/140FNHDEH***

Unit:mm

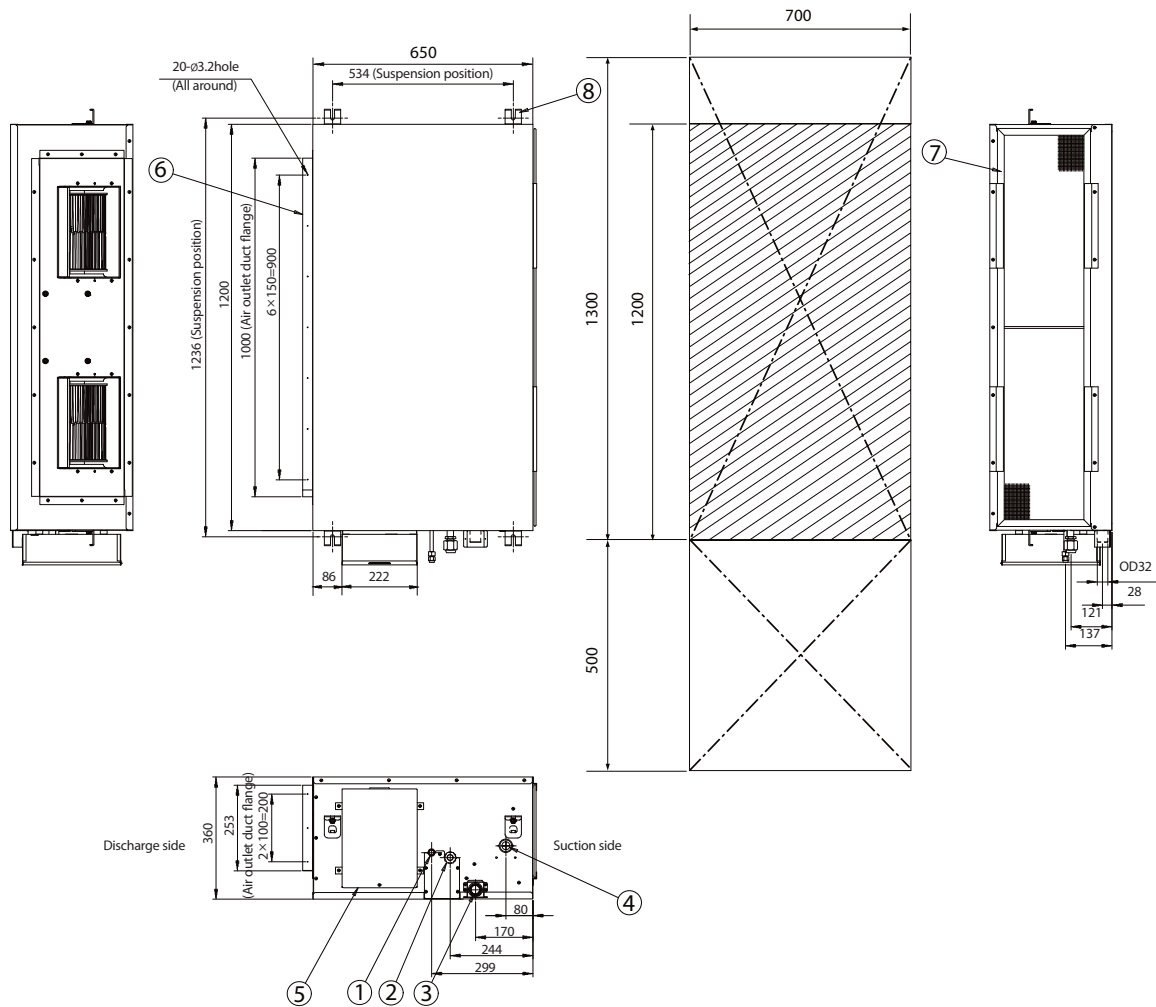

No.	Name	Description
①	Liquid pipe connection	Ø9.52 (3/8")
②	Gas pipe connection	Ø15.88 (5/8")
③	Drain pipe connection without optional drain pump kits	VP25 (OD 32, ID 25)
④	Drain pipe connection with optional drain pump kits	VP25 (OD 32, ID 25)
⑤	Power supply/Communication connection	
⑥	Air discharge grille flange	
⑦	Suction flange	
⑧	Hook	3/8" or M10

3 Dimensional drawing

HSP Duct

2) AM220/280FNHDEF***

Unit:mm

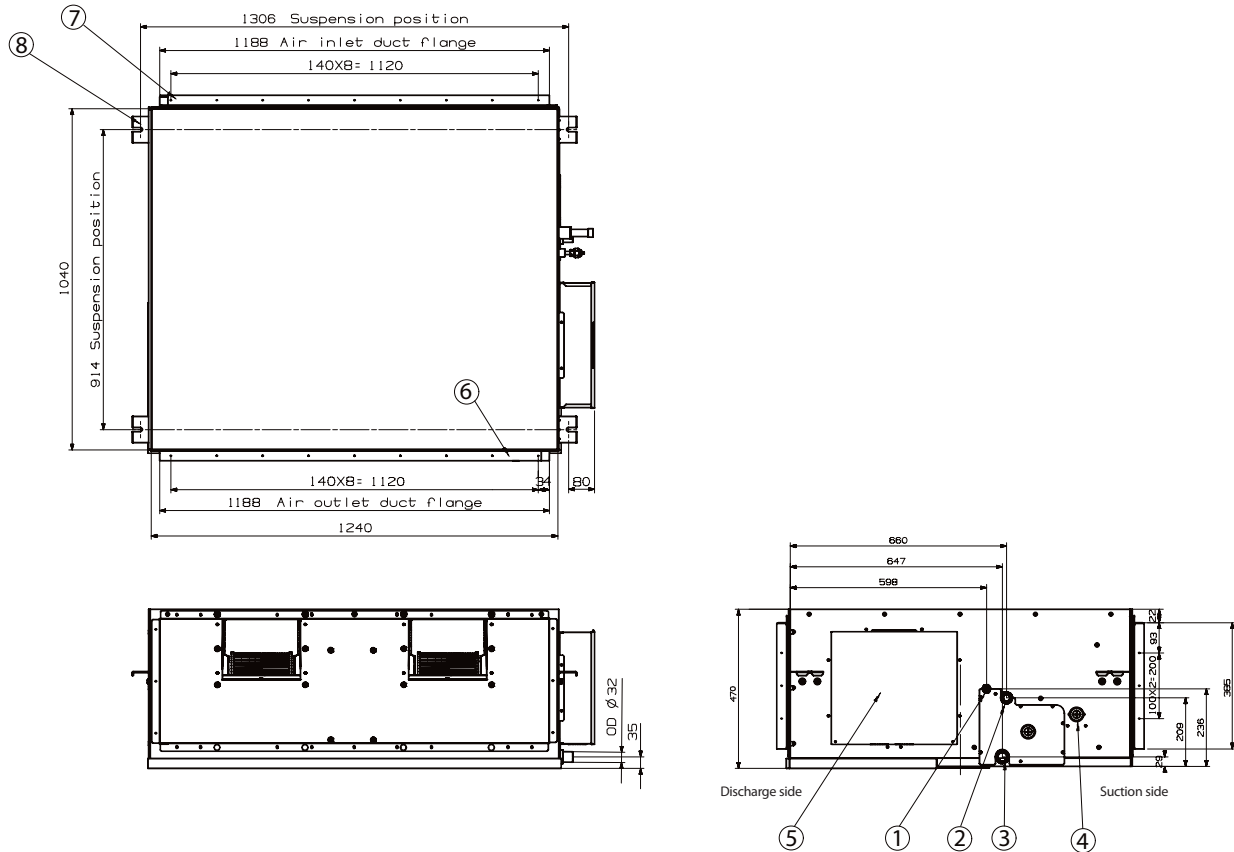

No.	Name	Description
①	Liquid pipe connection	Ø9.52 (3/8")
②	Gas pipe connection	AM220*** : Ø19.05 (3/4") AM280*** : Ø22.22 (7/8")
③	Drain pipe connection without optional drain pump kits	VP25 (OD 32, ID 25)
④	Drain pipe connection with optional drain pump kits	VP25 (OD 32, ID 25)
⑤	Power supply/Communication connection	
⑥	Air discharge grille flange	
⑦	Suction flange	
⑧	Hook	3/8" or M10

4 Electrical Wiring Diagram

HSP Duct

AM112/128/140FNHDEH/EU

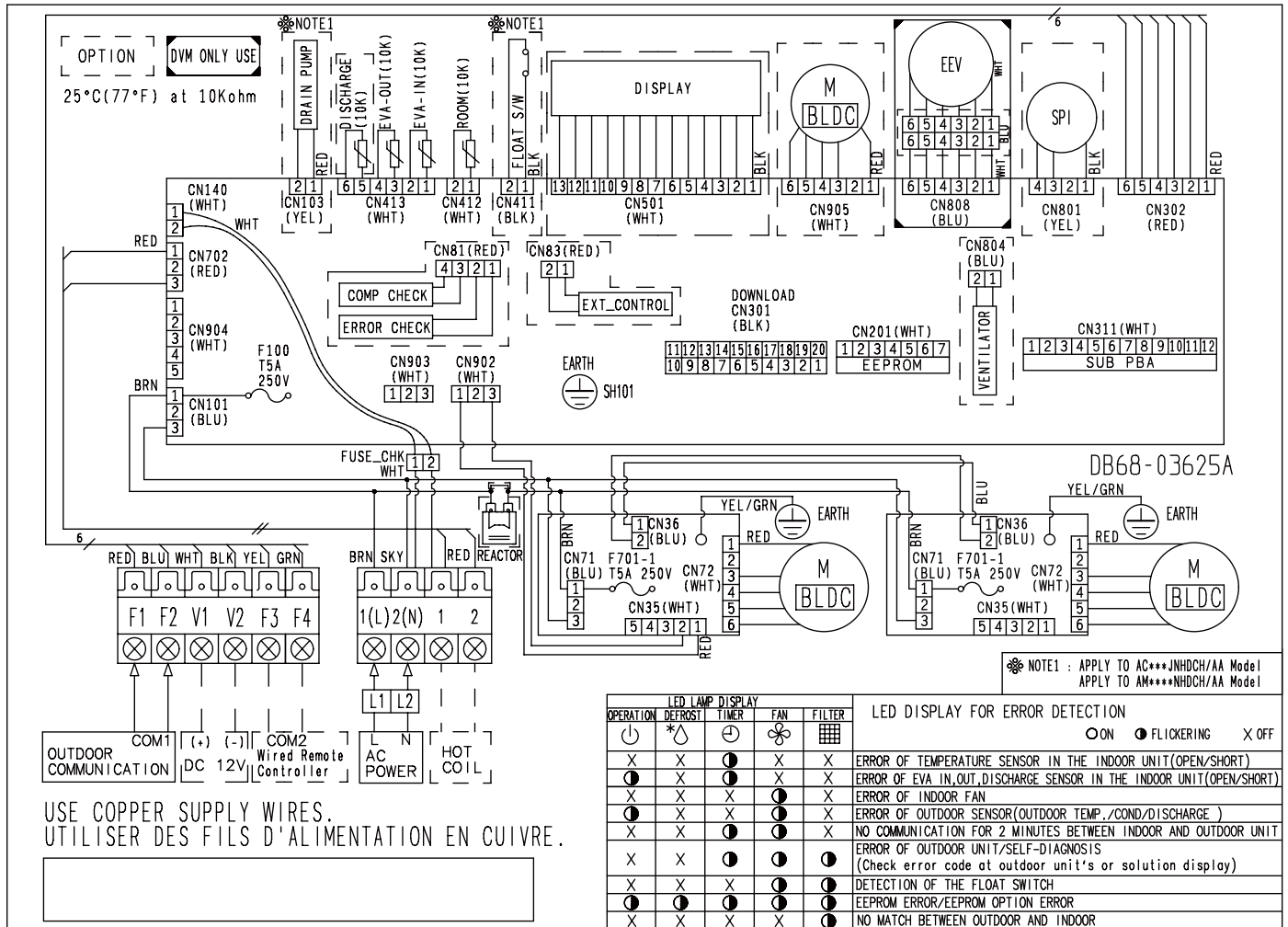

NOTE

1. This wiring diagram applies only to the indoor unit.
2. Symbols show as follow;
BLK : black, RED : red, BLU : blue, WHT:white, YEL : yellow, BRN : brown, SKY : sky-blue, GRN : green
3. For connection wiring indoor-outdoor transmission F1-F2, indoor-wired remotecontroller transmission F3-F4.
4. ⚡: Protective earth(screw), □□□□: Connector, n/___: The wire quantity

4 Electrical Wiring Diagram

HSP Duct

AM220/280FNHDEH/EU

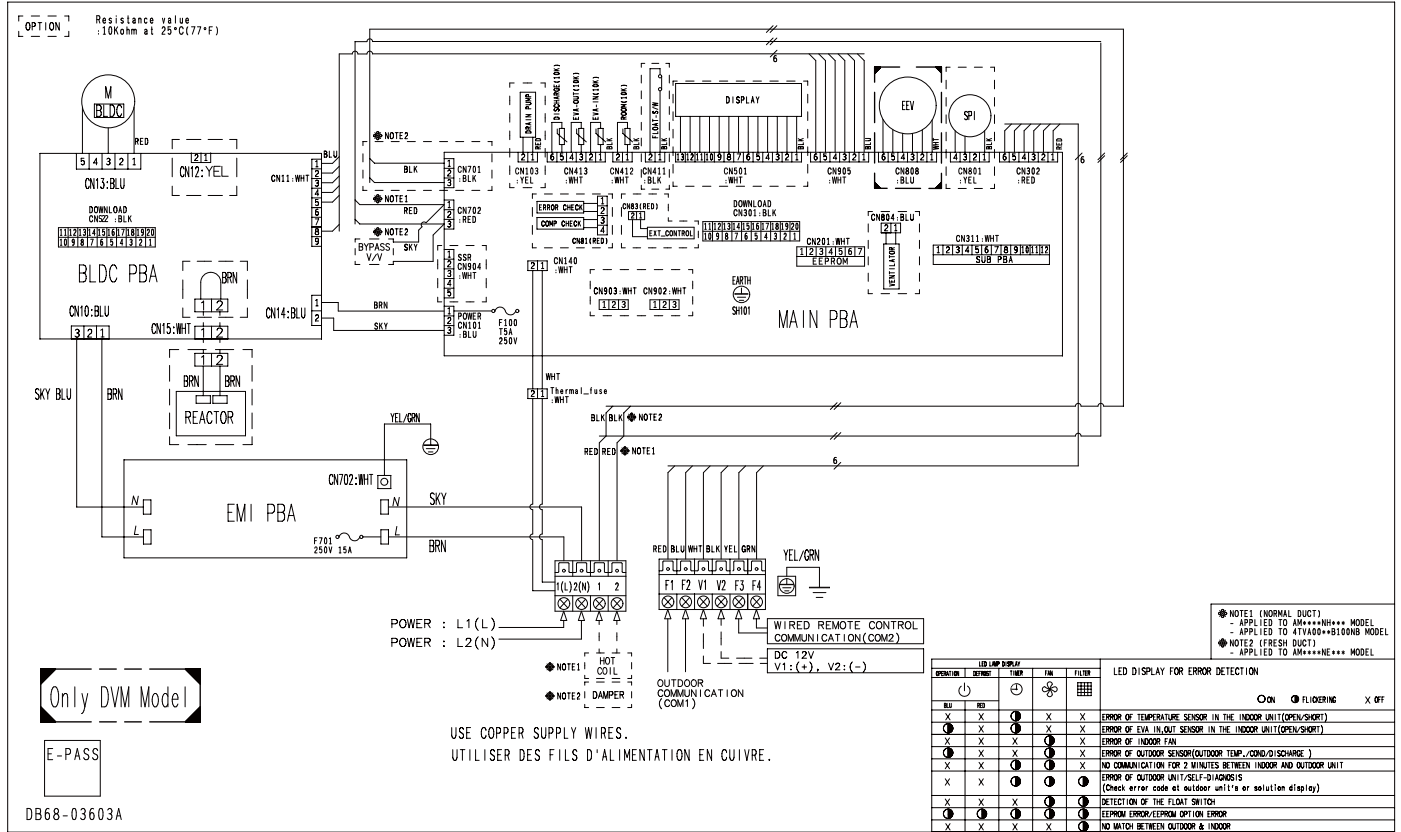

NOTE

1. This wiring diagram applies only to the indoor unit.
2. Symbols show as follow;
BLK : black, RED : red, BLU : blue, WHT:white, YEL : yellow, BRN : brown, SKY : sky-blue, GRN : green
3. For connection wiring indoor-outdoor transmission F1-F2, indoor-wired remotecontroller transmission F3-F4.
4. : Protective earth(screw), : Connector, n : The wire quantity

5 Sound pressure level

HSP Duct

1) Operation sound level

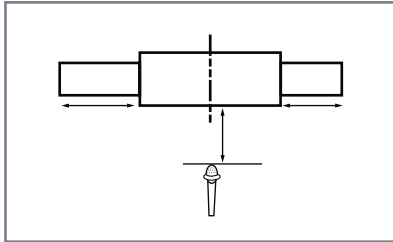

Unit : dB(A)

Model	High	Low
AM112FNHDEH ***	43	39
AM128FNHDEH ***	45	42
AM140FNHDEH ***	46	44
AM220FNHDEH ***	45	41
AM280FNHDEH ***	48	43

☑ Note

Specifications may be subject to change without prior notice.
 Sound pressure level is obtained in an anechoic room.
 Sound pressure level is a relative value, depending on the distance and acoustic environment.
 Sound pressure level may differ depending on operation condition.
 dBA = A-weighted sound pressure level
 Reference acoustic pressure 0 dB= 20 uPa

2) NR curves

(1) AM112FNHDEH ***

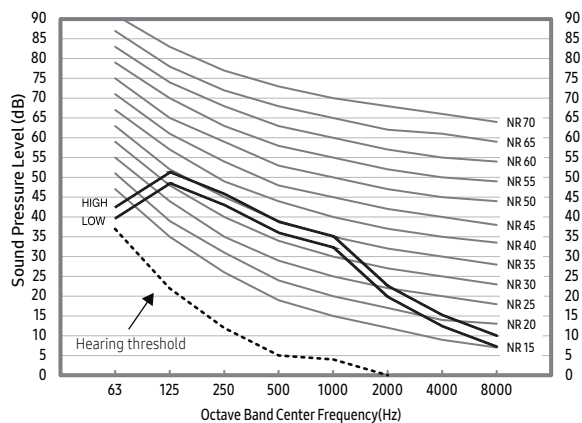

(2) AM128FNHDEH ***

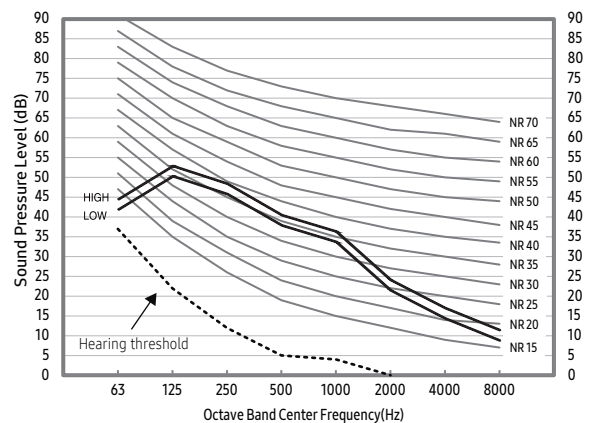

(3) AM140FNHDEH ***

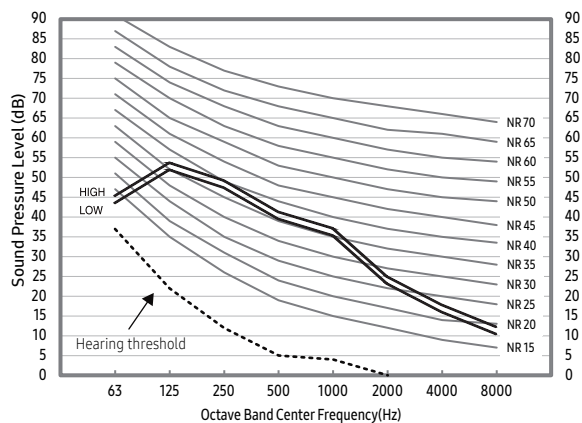

(4) AM220FNHDEH ***

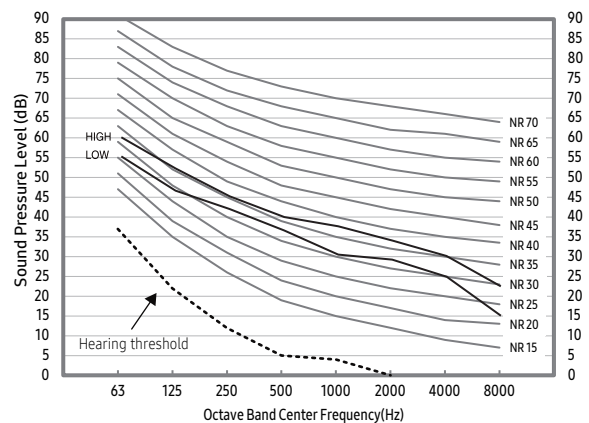

5 Sound pressure level

HSP Duct

(5) AM280FNHDEH ***

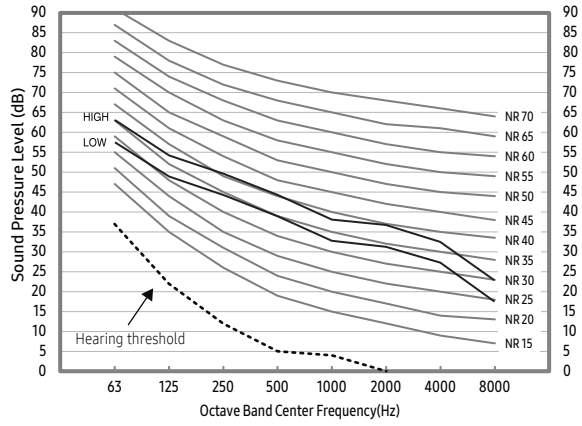

6 Fan Characteristics

HSP Duct

1) AM112FNHDEH/EU

①	External Static Pressure(mmAq)	Option Code
	$5 < SP \leq 7.5$	010054-1355E8-207070-331110

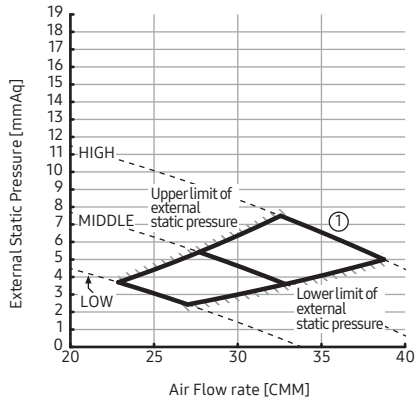

②	External Static Pressure(mmAq)	Option Code
	$7.5 < SP \leq 12.5$	010054-13598F-207070-331110

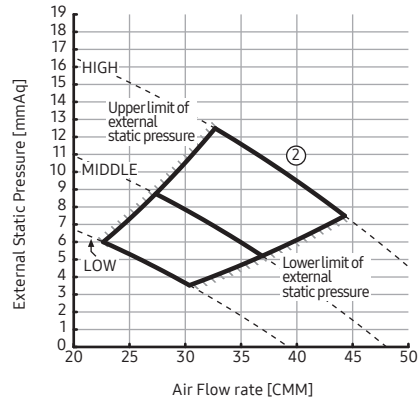

③	External Static Pressure(mmAq)	Option Code
	$12.5 < SP \leq 17.5$	010054-135E19-207070-331110

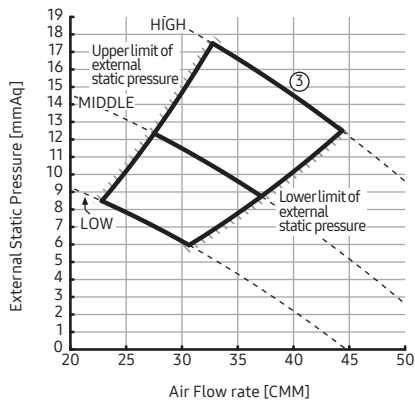

④	External Static Pressure(mmAq)	Option Code
	$17.5 < SP \leq 20$	010054-135F70-207070-331110

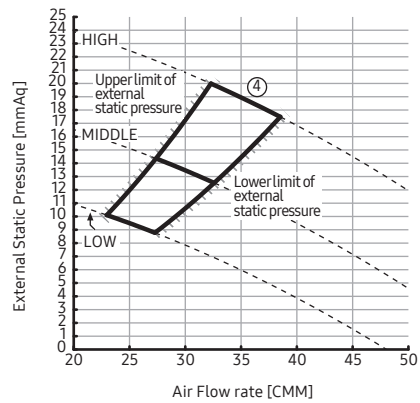

NOTE

1. ESP = External Static Pressuer
2. The graphs display the available external static pressure range of installed indoor units. Therefore, they do not reflect teh actual change of external static pressure and airflow rate according to adjusted airflow (High-Mid-Low) of installed indoor units.

6 Fan Characteristics

HSP Duct

2) AM128FNHDEH/EU

①	External Static Pressure(mmAq)	Option Code
	5 < SP ≤ 7.5	010054-13591C-208080-331110

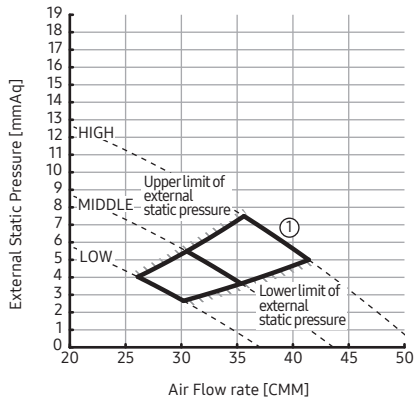

②	External Static Pressure(mmAq)	Option Code
	7.5 < SP ≤ 12.5	010054-135AC4-208080-331110

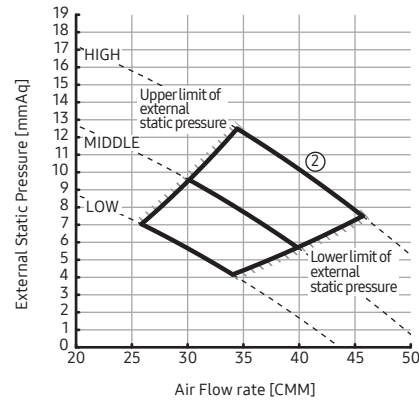

③	External Static Pressure(mmAq)	Option Code
	12.5 < SP ≤ 17.5	010054-135E4E-208080-331110

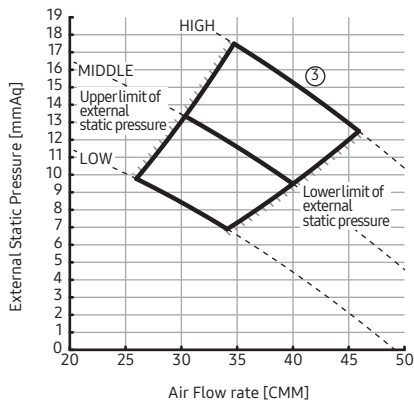

④	External Static Pressure(mmAq)	Option Code
	17.5 < SP ≤ 20	010054-135F95-208080-331110

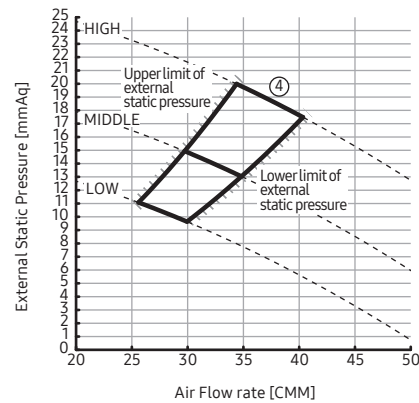

NOTE

1. ESP = External Static Pressuer
2. The graphs display the available external static pressure range of installed indoor units. Therefore, they do not reflect teh actual change of external static pressure and airflow rate according to adjusted airflow (High-Mid-Low) of installed indoor units.

6 Fan Characteristics

HSP Duct

3) AM140FNHDEH/EU

①	External Static Pressure(mmAq)	Option Code
	5 < SP ≤ 7.5	010054-13595E-208C8C-331110

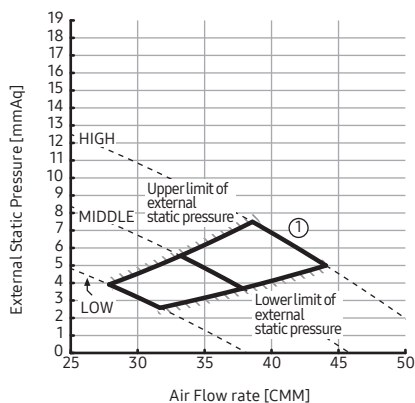

②	External Static Pressure(mmAq)	Option Code
	7.5 < SP ≤ 12.5	010054-135E09-208C8C-331110

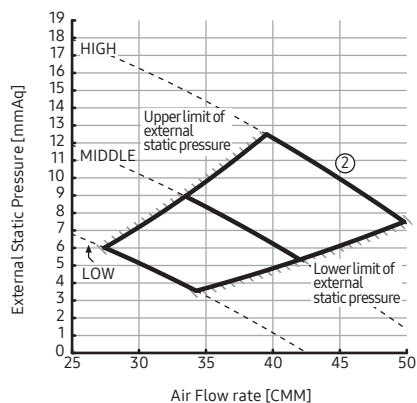

③	External Static Pressure(mmAq)	Option Code
	12.5 < SP ≤ 17.5	010054-135F71-208C8C-331110

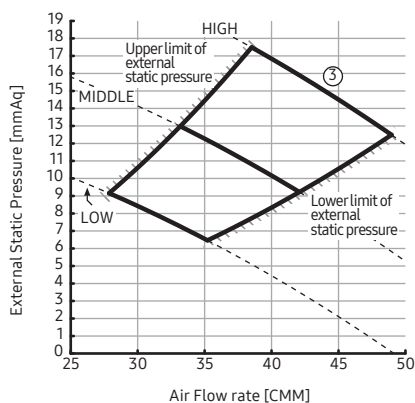

④	External Static Pressure(mmAq)	Option Code
	17.5 < SP ≤ 20	010054-135FB7-208C8C-331110

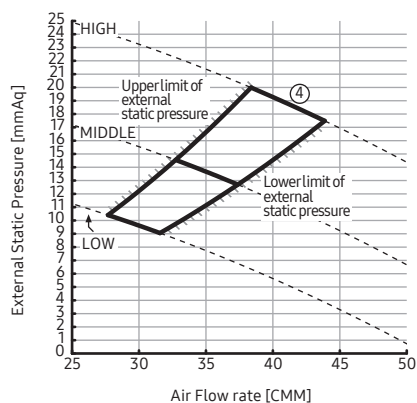

NOTE

1. ESP = External Static Pressuer
2. The graphs display the available external static pressure range of installed indoor units. Therefore, they do not reflect teh actual change of external static pressure and airflow rate according to adjusted airflow (High-Mid-Low) of installed indoor units.

6 Fan Characteristics

HSP Duct

4) AM220FNHDEH/EU

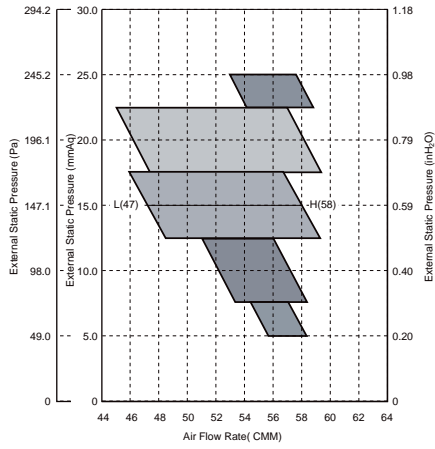

ESP (mmAq)	Option code
5	011054-195097-20DCDC-331110
10	011054-1950C7-20DCDC-331110
15	011054-1950E8-20DCDC-331110
20	011054-19544D-20DCDC-331110
25	011054-19549F-20DCDC-331110

5) AM280FNHDEH/EU

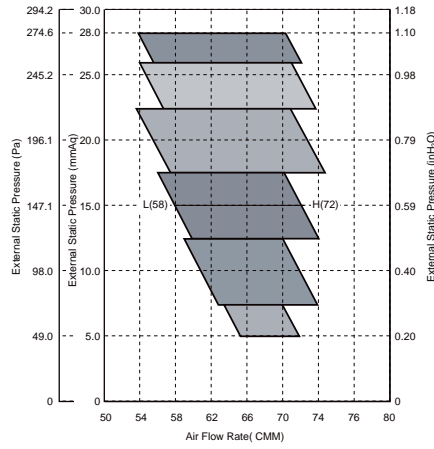

ESP (mmAq)	Option code
5	011054-195407-231C1C-331110
10	011054-195429-231C1C-331110
15	011054-19545B-231C1C-331110
20	011054-19549E-231C1C-331110
25	011054-1955D1-231C1C-331110
28	011054-1955F3-231C1C-331110

NOTE

1. ESP = External Static Pressuer
2. The graphs display the available external static pressure range of installed indoor units. Therefore, they do not reflect teh actual change of external static pressure and airflow rate according to adjusted airflow (High-Mid-Low) of installed indoor units.

Big Duct

- 1 *Specifications*
- 2 *Capacity Table*
- 3 *Dimensional Drawing*
- 4 *Electrical Wiring Diagram*
- 5 *Sound Pressure Level*
- 6 *Sound Power Level*
- 7 *Fan Characteristics*

1 Specifications

Big Duct

Type			HSP Duct		HSP Duct	
Model			AM180JNHFKH/EU		AM224JNHFKH/EU	
Power Supply			Ø, #, V, Hz	1,2,220-240,50		
Mode			-	HP/HR		
Performance	Capacity (Nominal)	Cooling	kW	18.00	22.40	
			Btu/h	61,400	76,400	
		Heating	kW	20.00	25.00	
			Btu/h	68,200	85,300	
Power	Power Input (Nominal)	Cooling	W	340.00	530.00	
		Heating		340.00	530.00	
	Current Input (Nominal)	Cooling	A	1.90	2.90	
		Heating		1.90	2.90	
Fan	Motor	Type	-	Sirocco		
		Output x n	w	630 x 1		
	Air Flow Rate	H/M/L (UL)	CMM	58.00 / 50.00 / 43.00		72.00 / 61.00 / 50.00
			l/s	966.67 / 833.33 / 716.67		1,200.00 / 1,016.67 / 833.33
	External Pressure	Min/Std/Max	mmAq	5.00 / 7.34 / 20.00		5.00 / 7.34 / 20.00
Pa			49.00 / 71.93 / 196.00		49.00 / 71.93 / 196.00	
Piping Connections	Liquid Pipe	Ø, mm	9.52		9.52	
		Ø, inch	3/8"		3/8"	
	Gas Pipe	Ø, mm	19.05		19.05	
		Ø, inch	3/4"		3/4"	
Drain Pipe	Ø, mm	VP25 (OD 25, ID 20)		VP25 (OD 25, ID 20)		
Field Wiring	Power Source Wire	mm ²	-		-	
	Transmission Cable	mm ²	0.75 - 1.50		0.75 - 1.50	
Refrigerant	Type	-	R410A		R410A	
	Control Method	-	EEV(O)		EEV(O)	
Sound	Pressure	High / Mid / Low	dB(A)	43 / 39 / 35		44 / 40 / 36
	Power	Cooling		80		81
Dimension	Net Weight		kg	82.5		82.5
	Shipping Weight		kg	92.0		92.0
	Net Dimensions (WxHxD)		mm	1,350 x 450 x 910		1,350 x 450 x 910
	Shipping Dimensions (WxHxD)		mm	1,612 x 519 x 984		1,612 x 519 x 984
Panel Size	Panel model		-	-		-
	Panel Net Weight		kg	-		-
	Shipping Weight		kg	-		-
	Net Dimensions (WxHxD)		mm	-		-
	Shipping Dimensions (WxHxD)		mm	-		-
Additional Accessories	Drain Pump	External	-	MDP-G075SP		MDP-G075SP
		Internal	-	MDP-G075SQ		MDP-G075SQ
	Air Filter		-	-		-

* Specifications may be subject to change without prior notice for product improvement.

*1) Mode

- HP : Heat Pump, HR : Heat Recovery

*2) Nominal cooling capacities are based on;

- Indoor temperature : 27°C DB, 19°C WB

- Outdoor temperature : 35°C DB, 24°C WB, Equivalent refrigerant piping : 7.5m, Level differences : 0m

*3) Nominal heating capacities are based on;

- Indoor temperature : 20°C DB, 15°C WB

- Outdoor temperature : 7°C DB, 6°C WB, Equivalent refrigerant piping : 7.5m, Level differences : 0m

*4) Sound pressure was acquired in an anechoic room. Thus actual noise level may be different depending on the installation conditions.

*5) These products contain R410A which is fluorinated greenhouse gas.

* Heat Exchanger type : Fin & Tube (Fin : Al, Tube : Cu)

2 Capacity table

Big Duct

Cooling

TC : Total Capacity, SHC : Sensible Heat Capacity

Capacity Index	Outdoor Air Temp. (°C, DB)	Indoor temperature													
		20(°C, DB)		23(°C, DB)		26(°C, DB)		27(°C, DB)		28(°C, DB)		30(°C, DB)		32(°C, DB)	
		14(°C, WB)		16(°C, WB)		18(°C, WB)		19(°C, WB)		20(°C, WB)		22(°C, WB)		24(°C, WB)	
		TC	SHC	TC	SHC	TC	SHC	TC	SHC	TC	SHC	TC	SHC	TC	SHC
180	10	12.7	10.8	15.0	12.2	17.0	13.1	18.0	13.5	19.1	13.8	21.1	14.0	22.3	14.3
	12	12.7	10.8	15.0	12.2	17.0	13.1	18.0	13.5	19.1	13.8	21.1	14.0	22.3	14.3
	14	12.7	10.8	15.0	12.2	17.0	13.1	18.0	13.5	19.1	13.8	21.1	14.0	22.3	14.2
	16	12.7	10.8	15.0	12.2	17.0	13.1	18.0	13.5	19.1	13.8	21.1	14.0	22.3	14.0
	18	12.7	10.8	15.0	12.2	17.0	13.1	18.0	13.5	19.1	13.8	21.1	14.0	22.1	14.0
	20	12.7	10.8	15.0	12.2	17.0	13.1	18.0	13.5	19.1	13.8	21.1	14.0	22.0	13.9
	21	12.7	10.8	15.0	12.2	17.0	13.1	18.0	13.5	19.1	13.8	21.1	14.0	22.0	13.9
	23	12.7	10.8	15.0	12.2	17.0	13.1	18.0	13.5	19.1	13.8	21.1	14.0	21.8	13.9
	25	12.7	10.8	15.0	12.2	17.0	13.1	18.0	13.5	19.1	13.8	21.1	14.0	21.7	13.9
	27	12.7	10.8	15.0	12.2	17.0	13.1	18.0	13.5	19.1	13.8	21.1	14.0	21.6	13.9
	29	12.7	10.8	15.0	12.2	17.0	13.1	18.0	13.5	19.1	13.8	21.1	14.0	21.6	13.9
	31	12.7	10.8	15.0	12.2	17.0	13.1	18.0	13.5	19.1	13.8	21.1	14.0	21.6	13.9
	33	12.7	10.8	15.0	12.2	17.0	13.1	18.0	13.5	19.1	13.8	21.1	14.0	21.6	13.9
	35	12.7	10.8	15.0	12.2	17.0	13.1	18.0	13.5	19.1	13.8	21.1	14.0	21.6	13.9
	37	12.5	10.7	14.8	12.0	17.0	13.0	18.0	13.5	18.9	13.8	20.9	13.9	21.4	13.8
	39	12.3	10.7	14.5	12.0	17.0	13.0	17.9	13.4	18.9	13.8	20.7	13.8	21.1	13.6
	42	12.3	10.7	14.5	11.8	16.8	12.9	17.7	13.2	18.8	13.8	20.3	13.6	20.5	13.4
44	12.3	10.7	14.5	11.8	16.4	12.6	17.1	12.8	18.3	13.4	19.5	13.5	19.8	13.2	
46	12.3	10.7	14.4	11.7	16.1	12.4	16.6	12.4	17.7	13.0	18.9	13.3	19.3	12.7	
48	12.1	10.5	14.2	11.6	15.8	12.2	16.1	12.1	17.4	12.8	18.3	12.9	18.6	12.2	
224	10	15.8	13.8	18.7	15.4	21.2	16.6	22.4	17.1	23.9	17.7	26.4	18.1	27.9	18.3
	12	15.8	13.8	18.7	15.4	21.2	16.6	22.4	17.1	23.9	17.8	26.4	18.2	27.9	18.4
	14	15.8	13.8	18.7	15.4	21.2	16.6	22.4	17.1	23.9	17.8	26.4	18.2	27.9	18.1
	16	15.8	13.8	18.7	15.4	21.2	16.6	22.4	17.1	23.9	17.8	26.4	18.2	27.9	18.3
	18	15.8	13.8	18.7	15.4	21.2	16.6	22.4	17.1	23.9	17.8	26.4	18.2	27.8	18.1
	20	15.8	13.8	18.7	15.4	21.2	16.6	22.4	17.1	23.9	17.8	26.4	18.2	27.4	18.0
	21	15.8	13.8	18.7	15.4	21.2	16.6	22.4	17.1	23.9	17.8	26.4	18.2	27.5	18.0
	23	15.8	13.8	18.7	15.4	21.2	16.6	22.4	17.1	23.9	17.8	26.4	18.3	27.1	17.7
	25	15.8	13.8	18.7	15.4	21.2	16.6	22.4	17.1	23.9	17.8	26.4	18.2	27.0	17.8
	27	15.8	13.8	18.7	15.4	21.2	16.6	22.4	17.1	23.9	17.8	26.4	18.2	27.0	17.8
	29	15.8	13.8	18.7	15.4	21.2	16.6	22.4	17.1	23.9	17.8	26.4	18.2	27.0	17.8
	31	15.8	13.8	18.7	15.4	21.2	16.6	22.4	17.1	23.9	17.8	26.4	18.3	27.0	17.8
	33	15.8	13.8	18.7	15.4	21.2	16.6	22.4	17.1	23.9	17.8	26.4	18.5	27.0	17.8
	35	15.8	13.8	18.7	15.4	21.2	16.6	22.4	17.1	23.9	17.7	26.4	18.5	27.0	18.0
	37	15.5	13.6	18.4	15.2	21.1	16.5	22.4	17.1	23.7	17.7	26.0	18.2	26.6	17.6
	39	15.3	13.5	18.1	15.0	21.1	16.5	22.3	17.0	23.7	17.7	25.7	18.4	26.2	17.5
	42	15.3	13.5	18.1	15.0	20.9	16.4	22.0	16.8	23.4	17.5	25.3	18.1	25.5	17.1
44	15.3	13.5	18.1	15.0	20.4	15.9	21.3	16.2	22.8	17.0	24.2	17.4	24.7	16.5	
46	15.3	13.5	17.9	14.9	20.0	15.7	20.6	15.7	22.1	16.5	23.5	16.8	24.0	16.0	
48	15.1	13.3	17.7	14.7	19.7	15.4	20.1	15.3	21.6	16.2	22.8	16.3	23.2	15.5	

2 Capacity table

Big Duct

Heating

TC : Total Capacity

Capacity Index	Outdoor Air Temp. (°C)		Indoor temperature (°C,DB)				
			16(°C,DB)	18(°C,DB)	20(°C,DB)	22(°C,DB)	24(°C,DB)
	DB	WB	TC kW	TC kW	TC kW	TC kW	TC kW
180	-19.8	-20.0	16.3	15.6	14.7	14.0	13.5
	-18.8	-19.0	16.4	15.8	14.9	14.3	13.9
	-16.7	-17.0	16.7	16.1	15.2	14.8	14.6
	-14.7	-15.0	17.4	16.7	15.8	15.4	15.1
	-12.6	-13.0	18.2	17.5	16.5	16.0	15.8
	-10.5	-11.0	19.4	18.6	17.6	16.9	16.7
	-9.5	-10.0	19.9	19.1	18.0	17.2	17.0
	-8.5	-9.1	20.0	19.2	18.2	17.5	17.2
	-7.0	-7.6	20.2	19.4	18.4	17.8	17.6
	-5.0	-5.6	20.8	20.0	19.0	18.6	18.0
	-3.0	-3.7	21.2	20.4	19.4	19.2	18.4
	0.0	-0.7	21.6	21.0	19.8	19.4	18.8
	3.0	2.2	22.2	21.4	20.0	19.4	18.8
	5.0	4.1	22.4	21.4	20.0	19.4	18.8
	7.0	6.0	22.6	21.4	20.0	19.4	18.8
9.0	7.9	22.6	21.4	20.0	19.4	18.8	
11.0	9.8	22.6	21.4	20.0	19.4	18.8	
13.0	11.8	22.6	21.4	20.0	19.4	18.8	
15.0	13.7	22.6	21.4	20.0	19.4	18.8	
224	-19.8	-20.0	20.3	19.5	18.4	17.6	16.9
	-18.8	-19.0	20.5	19.7	18.6	17.9	17.4
	-16.7	-17.0	20.9	20.1	19.0	18.5	18.3
	-14.7	-15.0	21.7	20.8	19.7	19.2	18.9
	-12.6	-13.0	22.7	21.8	20.6	20.0	19.8
	-10.5	-11.0	24.3	23.3	22.0	21.1	20.8
	-9.5	-10.0	24.8	23.8	22.5	21.6	21.3
	-8.5	-9.1	25.1	24.1	22.7	21.9	21.6
	-7.0	-7.6	25.4	24.4	23.0	22.3	22.0
	-5.0	-5.6	26.2	25.2	23.7	23.2	22.6
	-3.0	-3.7	26.8	25.8	24.3	24.1	23.1
	0.0	-0.7	27.4	26.5	24.9	24.3	23.7
	3.0	2.2	28.0	27.0	25.0	24.4	23.6
	5.0	4.1	28.3	27.0	25.0	24.4	23.6
	7.0	6.0	28.8	27.0	25.0	24.4	23.6
9.0	7.9	28.8	27.0	25.0	24.4	23.6	
11.0	9.8	28.8	27.0	25.0	24.4	23.6	
13.0	11.8	28.8	27.0	25.0	24.4	23.6	
15.0	13.7	28.8	27.0	25.0	24.4	23.6	

3 Dimensional drawing

Big Duct

AM180JNHFKH/EU, AM224JNHFKH/EU

Units : mm / inches

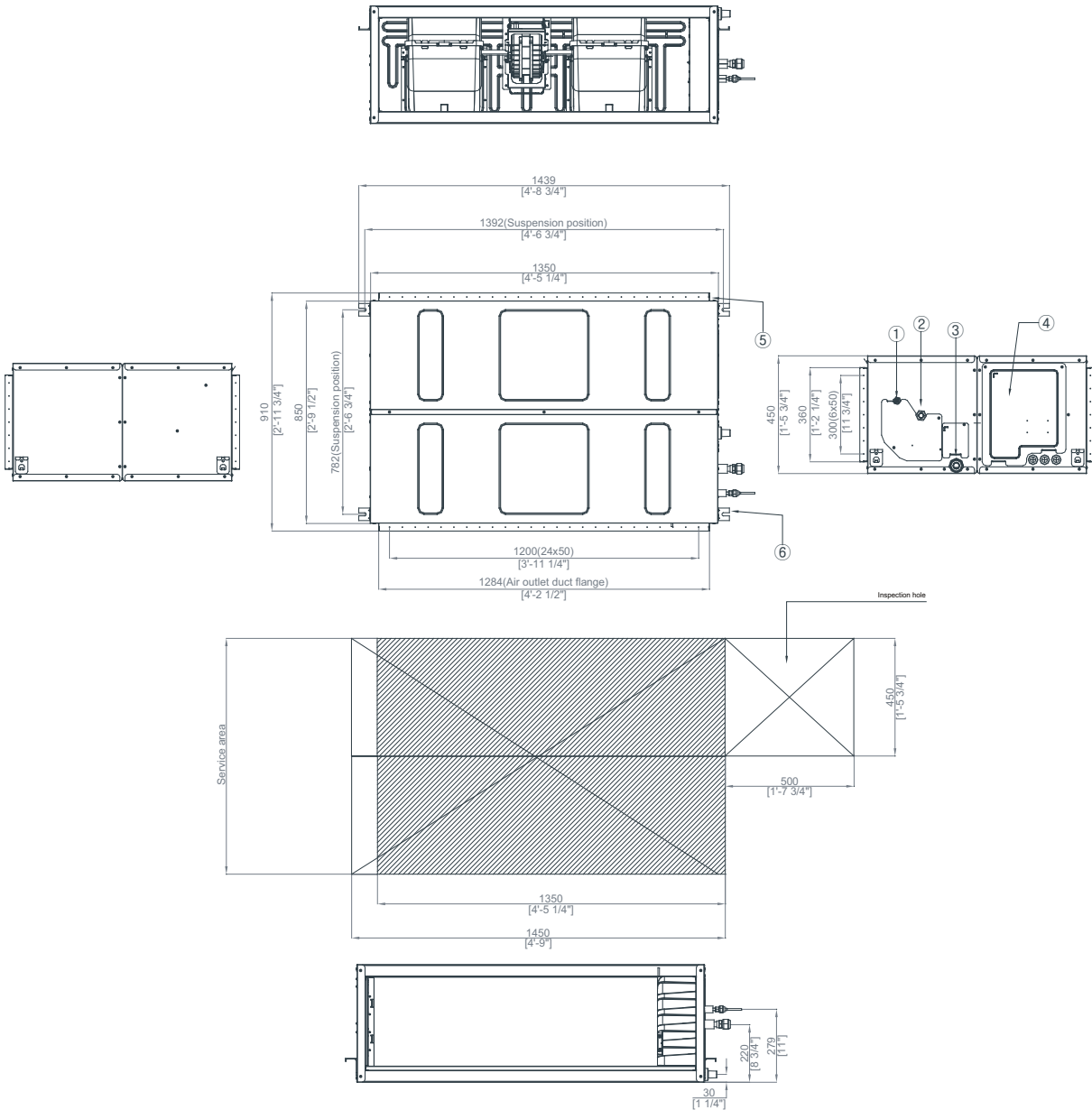

Table of descriptions

1	Liquid pipe connection	7	
2	Gas pipe connection	8	
3	Drain pipe connection	9	
4	Power supply connection	10	
5	Air discharge flange	11	
6	Hook	12	

4 Electrical Wiring Diagram

Big Duct

AM180/224JNHFKH/EU

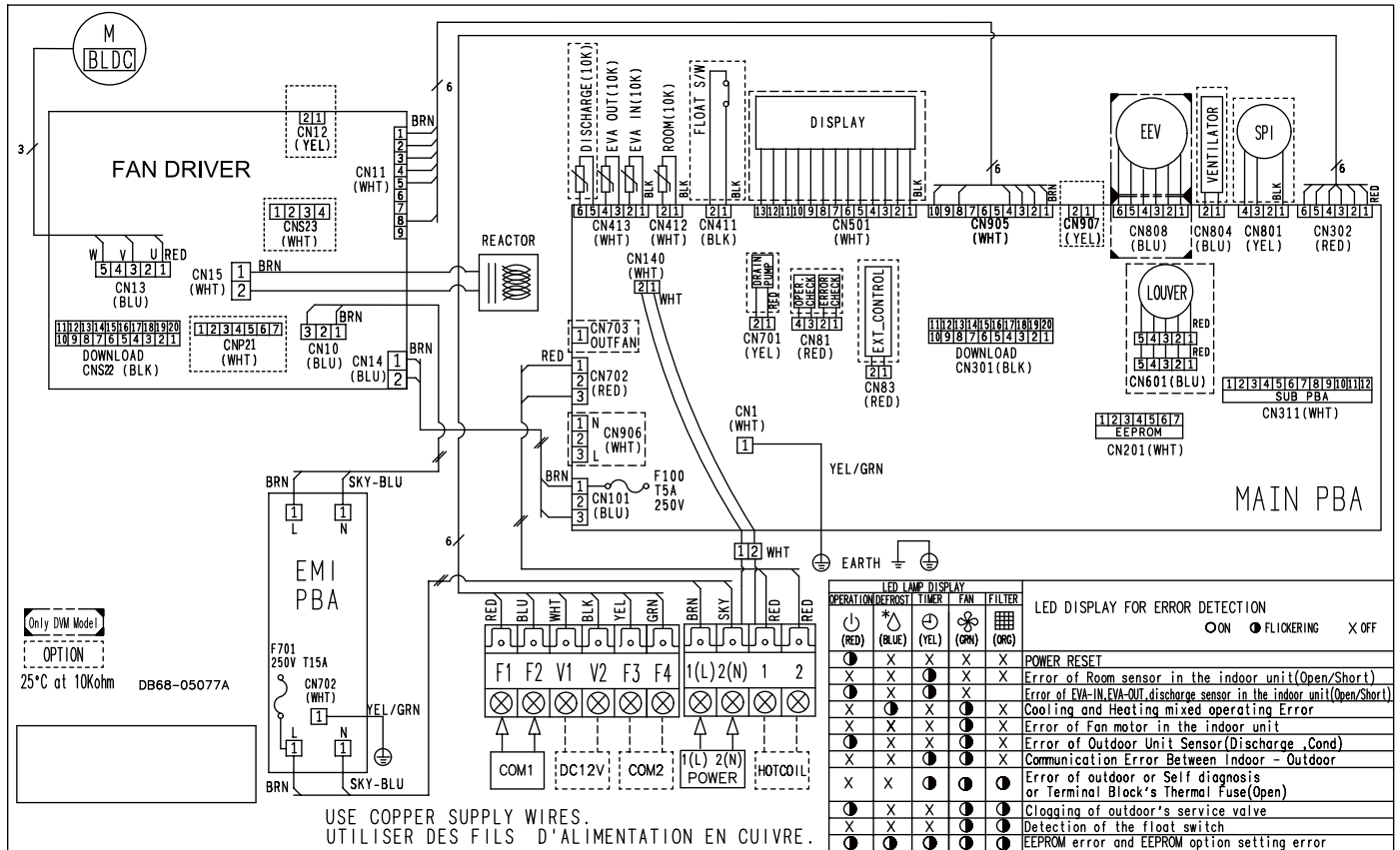

NOTE

- This wiring diagram applies only to the indoor unit.
- Symbols show as follow;
BLK : black, RED : red, BLU : blue, WHT:white, YEL : yellow, BRN : brown, SKY : sky-blue, GRN : green
- For connection wiring indoor-outdoor transmission F1-F2, indoor-wired remotecontroller transmission F3-F4.
- ⊕: Protective earth(screw), □□□□: Connector, n: The wire quantity

5 Sound pressure level

Big Duct

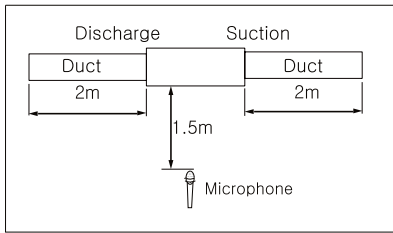

Unit: dB(A)

Model	High	Low
AM180JNHFKH/EU	43	35
AM224JNHFKH/EU	44	36

Note

Specifications may be subject to change without prior notice.
 Sound pressure level is obtained in an anechoic room.
 Sound pressure level is a relative value, depending on the distance and acoustic environment.
 Sound pressure level may differ depending on operation condition.
 dBA = A-weighted sound pressure level
 Reference acoustic pressure 0 dB= 20 uPa

NR curve

1) AM180JNHFKH/EU

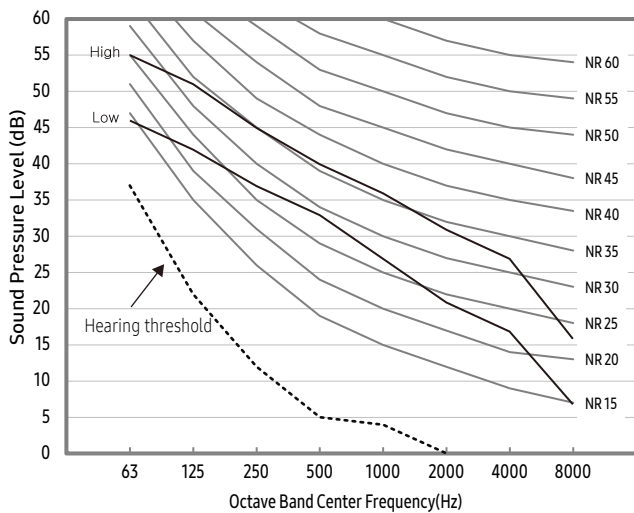

2) AM224JNHFKH/EU

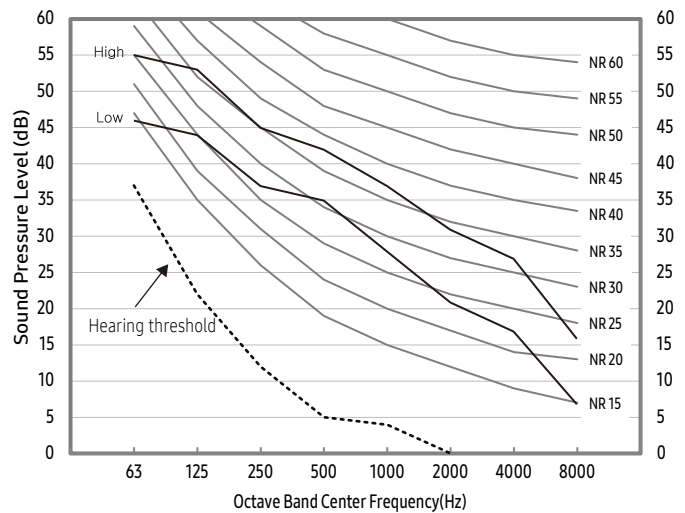

6 Sound power level

Big Duct

Note

- . Specifications may be subject to change without prior notice.
- . Sound power level is an absolute value that a sound source generates.
- . dBA = A-weighted sound power level.
- . Reference power : 1pW.
- . Measured according to ISO 3741

Unit: dB(A)

Model	Power
AM180JNHFKH/EU	80
AM224JNHFKH/EU	81

1)AM180JNHFKH/EU

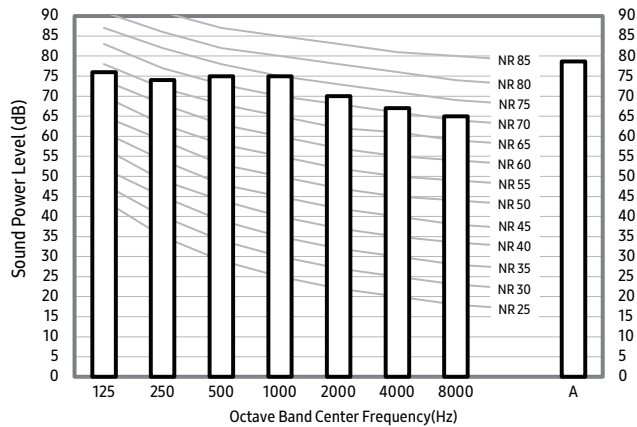

2)AM224JNHFKH/EU

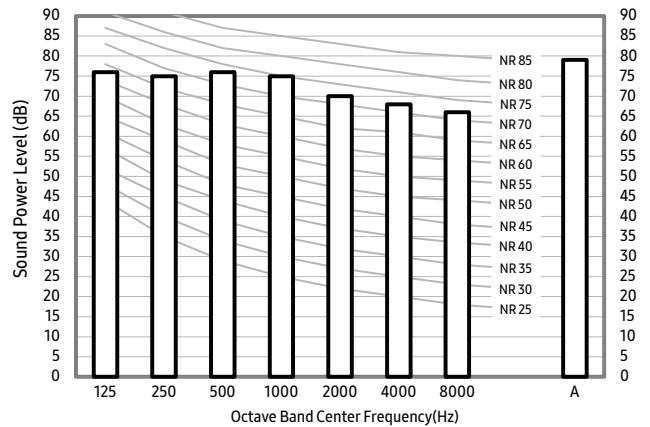

7 Fan Characteristics

Big Duct

1) AM180JNHFKH/EU

①	External Static Pressure(mmAq)	Option Code
	$5 < SP \leq 7.5$	12074-1C5080-20B4B4-331110

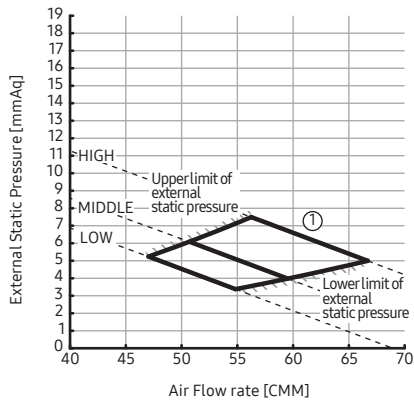

②	External Static Pressure(mmAq)	Option Code
	$7.5 < SP \leq 10$	12074-1C50A1-20B4B4-33111

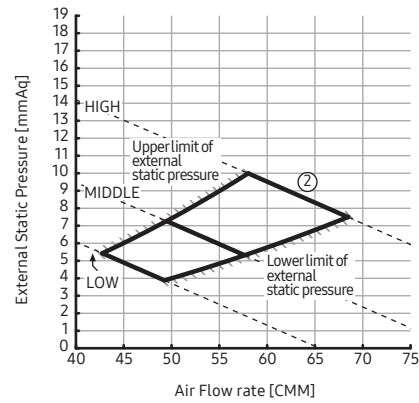

③	External Static Pressure(mmAq)	Option Code
	$10 < SP \leq 12.5$	12074-1C50D3-20B4B4-331110

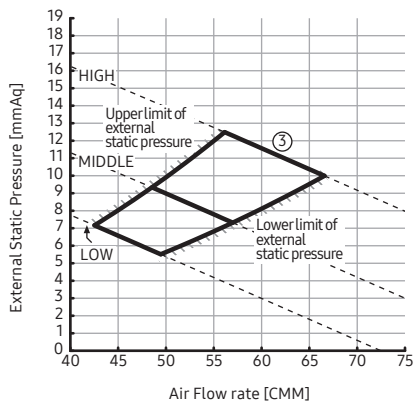

④	External Static Pressure(mmAq)	Option Code
	$12.5 < SP \leq 15$	12074-1C50F5-20B4B4-331110

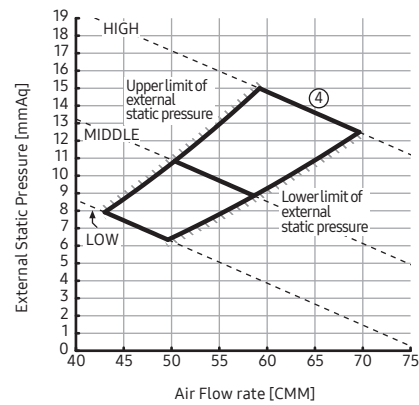

⑤	External Static Pressure(mmAq)	Option Code
	$15 < SP \leq 17.5$	12074-1C5437-20B4B4-331110

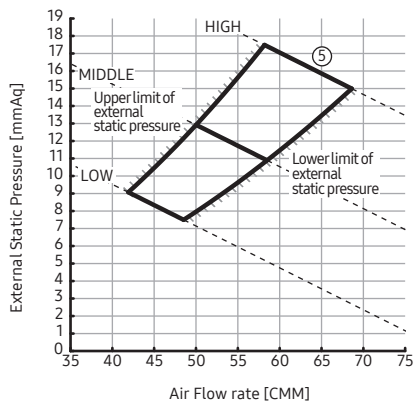

⑥	External Static Pressure(mmAq)	Option Code
	$17.5 < SP \leq 20$	12074-1C5448-20B4B4-331110

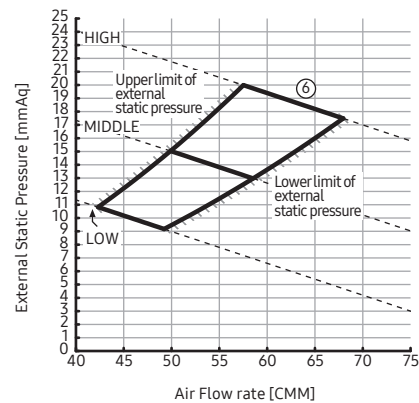

NOTE

1. ESP = External Static Pressuer
2. The graphs display the available external static pressure range of installed indoor units. Therefore, they do not reflect teh actual change of external static pressure and airflow rate according to adjusted airflow (High-Mid-Low) of installed indoor units.

7 Fan Characteristics

Big Duct

2) AM224JNHFKH/EU

①	External Static Pressure(mmAq)	Option Code
	$5 < SP \leq 7.5$	12074-1C50C0-20E0E0-331110

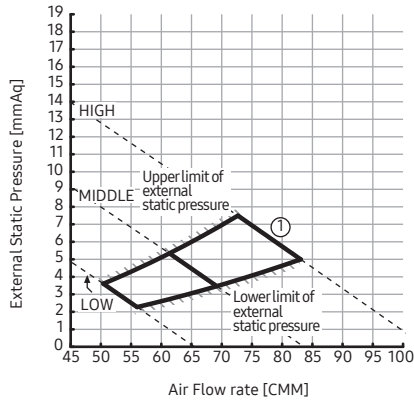

②	External Static Pressure(mmAq)	Option Code
	$7.5 < SP \leq 10$	12074-1C50E3-20E0E0-331110

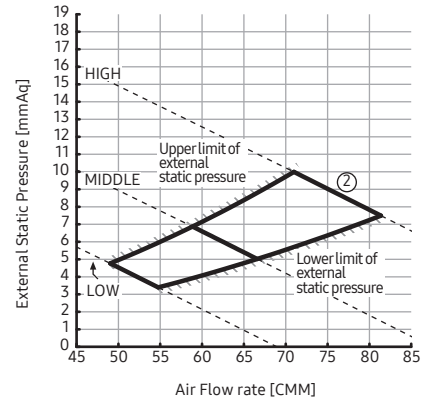

③	External Static Pressure(mmAq)	Option Code
	$10 < SP \leq 12.5$	12074-1C50F5-20E0E0-331110

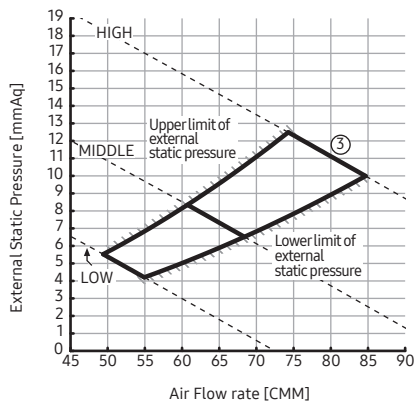

④	External Static Pressure(mmAq)	Option Code
	$12.5 < SP \leq 15$	12074-1C5436-20E0E0-331110

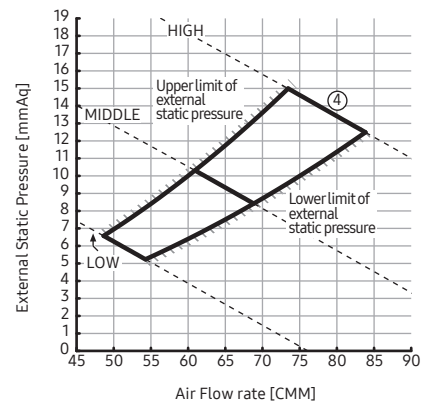

⑤	External Static Pressure(mmAq)	Option Code
	$15 < SP \leq 17.5$	12074-1C5458-20E0E0-331110

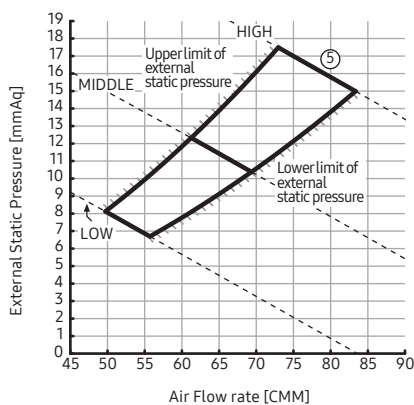

⑥	External Static Pressure(mmAq)	Option Code
	$17.5 < SP \leq 20$	12074-1C548E-20E0E0-331110

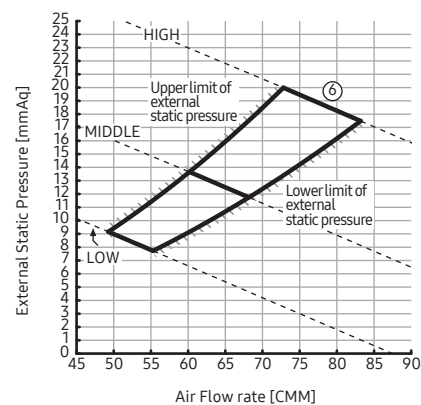

NOTE

1. ESP = External Static Pressuer
2. The graphs display the available external static pressure range of installed indoor units. Therefore, they do not reflect teh actual change of external static pressure and airflow rate according to adjusted airflow (High-Mid-Low) of installed indoor units.

Home Duct

- 1 *Specifications*
- 2 *Summary Table*
- 3 *Capacity Table*
- 4 *Dimensional Drawing*
- 5 *Center of Gravity*
- 6 *Electrical Wiring Diagram*
- 7 *Sound data*
- 8 *Fan Characteristics*
- 9 *Piping Diagram*

Features & Benefits

Slim design of height 199mm : can easily mounted in a ceiling

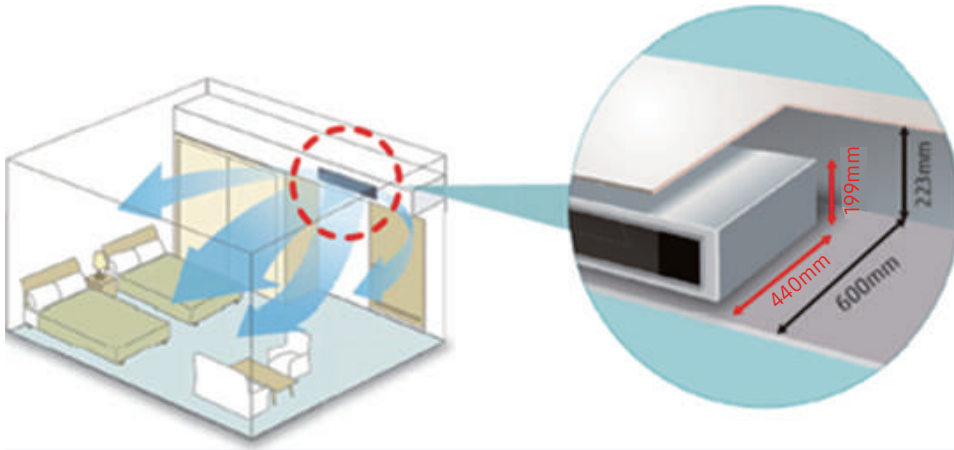

Built-in drain pump with 750mm lift : increase installation speed and pipe work flexibility



Samsung		Compatitors		
Old Model	New Model	"A" company	"B" company	"C" company
600mm	440mm	450mm	447mm	460mm

Line-up

Indoor unit

Model	Capacity (kW)		
	4.5	5.6	7.1
	AM045MNLDEH/EU	AM056MNLDEH/EU	AM071MNLDEH/EU
Home DUCT			

1. Specification

Home DUCT

Type			Home Duct	Home Duct	Home Duct	
Model Name			AM045MNLDEH/EU	AM056MNLDEH/EU	AM071MNLDEH/EU	
Power Supply		Φ, #, V, Hz	1,220~240,50	1,220~240,50	1,220~240,50	
Mode		-	HP	HP	HP	
Performance	Capacity	Cooling	kW	4.5	5.6	7.1
			Btu/h	15400	19100	24200
	Heating	kW	5	6.3	8	
		Btu/h	17100	21500	27300	
Power	Power Input	Cooling	W	51	73	82
		Heating		46	68	77
	Current Input	Cooling	A	0.45	0.62	0.69
		Heating		0.41	0.58	0.65
	Current	MCA	A	0.56	0.78	0.86
		MFA		15	15	15
Heat Ex-changer	Type		-	Fin & Tube	Fin & Tube	Fin & Tube
	Material	Fin	-	Al	Al	Al
		Tube	-	Cu	Cu	Cu
	Fin Treatment		-	Green Hydrophile	Green Hydrophile	Green Hydrophile
Fan	Type		-	Sirocco Fan	Sirocco Fan	Sirocco Fan
	Quantity		EA	2	2	3
	Air Flow Rate	H/M/L	m ³ /min	12.50/10.00/7.50	15.50/12.50/9.50	18.00/14.50/11.00
			l/s	208.33/166.67/125.00	258.33/208.33/158.33	300/241.67/183.33
	External Pressure	Max. (Min/Std/Max)	mmAq	4 (0/2/4)	4 (0/2/4)	4 (0/2/4)
			Pa	39.2 (0/19.6/39.2)	39.2 (0/19.6/39.2)	39.2 (0/19.6/39.2)
Fan Motor	Model		-	BLDC	BLDC	BLDC
	Output x n		W	84 x 1	84 x 1	84 x 1
Piping Connections	Liquid Pipe		Type	Flare connection	Flare connection	Flare connection
			Φ, mm (inch)	6.35 (1/4)	6.35 (1/4)	9.52 (3/8)
	Gas Pipe		Type	Flare Connection	Flare Connection	Flare Connection
			Φ, mm (inch)	12.70 (1/2)	12.70 (1/2)	15.88 (5/8)
	Heat Insulation		-	Both Insulation	Both Insulation	Both Insulation
Drain Pipe		Φ,mm	Both Insulation	Both Insulation	Both Insulation	
Wiring Connection	Communication	Min.	mm ²	0.75	0.75	0.75
		Remark	-	F1, F2	F1, F2	F1, F2
Refrigerant	Type		-	R410A	R410A	R410A
	Electronic Expansion Valve		-	EEV INCLUDED	EEV INCLUDED	EEV INCLUDED
Sound	Sound Pressure Level	H/M/L	dB(A)	32/28/25	34/30/26	34/30/27
	Sound Power Level	Cooling		49	51	53

1. Specification

Home DUCT

Type			Home Duct	Home Duct	Home Duct
Model Name			AM045MNLDEH/EU	AM056MNLDEH/EU	AM071MNLDEH/EU
Dimensions	Net Weight	kg	18.9	18.9	22.3
	Shipping Weight	kg	21.8	21.8	25.3
	Net Dimensions (W×H×D)	mm	900×199×440	900×199×440	1100×199×440
	Shipping Dimensions (W×H×D)	mm	1151×280×544	1151×280×544	1351×280×544
Casing	Material	-	GI-SGCC	GI-SGCC	GI-SGCC
Drain Pump	Drain Pump	-	Drain Pump Included	Drain Pump Included	Drain Pump Included
	Max. lifting Height / Displacement	mm / Liter/h	750/24	750/24	750/24
Additional Accessories	Air Filter	-	Filter Included	Filter Included	Filter Included

NOTE

- Specification may be subject to change without prior notice.
 - 1) Mode : HP(Heat Pump), HR(Heat Recovery)
 - 2) Performances are based on the following test conditions.
 - Cooling : Indoor temperature 27°C DB, 19°C WB, Outdoor temperature 35°C DB, 24°C WB
 - Heating : Indoor temperature 20°C DB, 15°C WB, Outdoor temperature 7°C DB, 6°C WB
 - Equivalent refrigerant piping length 7.5m, Level differences 0m
 - 3) Sound pressure level is obtained in an anechoic room.
 - Sound pressure level is a relative value, depending on the distance and acoustic environment.
 - Sound pressure level may differ depending on operation condition.
 - dBA = A-weighted sound pressure level
 - Reference acoustic pressure 0 dB = 20uPa
 - 4) Sound power level is an absolute value that a sound source generates.
 - dBA = A-weighted sound power level
 - Reference power : 1pW
 - Measured according to ISO 3741
 - 5) Select wire size based on the value of MCA

2. Summary Table

Home DUCT

Performance Characteristics

Model Code	Capacity(kW)		Fan speed	
	Cooling	Heating	Mode	CMM
AM045MNLDEH/EU	4.5	5.0	H / M / L	12.50/10.00/7.50
AM056MNLDEH/EU	5.6	6.3		15.50/12.50/9.50
AM071MNLDEH/EU	7.1	8.0		18.00/14.50/11.00

Electrical Characteristics

Indoor Unit	Power Supply (Ø, #, V, Hz)	Power Input (W)	Current Input (A)	MCA (A)	MFA (A)	FLA (A)
AM045MNLDEH/EU	1,2,220-240, 50Hz	51	0.45	0.56	15	0.45
AM056MNLDEH/EU		73	0.62	0.78	15	0.62
AM071MNLDEH/EU		82	0.69	0.86	15	0.69

NOTE

- MCA : Minimum circuit amperes
- MFA: Maximum fuse amperes
- FLA: Full load amperes
- Select wire size based on the value of MCA

3. Capacity Table

Home DUCT

Cooling

TC: Total Capacity, SHC: Sensible Heat Capacity

Capacity Index	Outdoor Air Temp. (°C, DB)	Indoor temperature													
		20(°C, DB)		23(°C, DB)		26(°C, DB)		27(°C, DB)		28(°C, DB)		30(°C, DB)		32(°C, DB)	
		14(°C, WB)		16(°C, WB)		18(°C, WB)		19(°C, WB)		20(°C, WB)		22(°C, WB)		24(°C, WB)	
		TC	SHC	TC	SHC	TC	SHC	TC	SHC	TC	SHC	TC	SHC	TC	SHC
045	10	3.1	2.7	3.7	3.1	4.2	3.2	4.5	3.3	4.7	3.3	5.0	3.3	5.4	3.4
	12	3.1	2.7	3.7	3.1	4.2	3.2	4.5	3.3	4.7	3.3	5.0	3.3	5.4	3.4
	14	3.1	2.7	3.7	3.1	4.2	3.2	4.5	3.3	4.7	3.3	5.0	3.3	5.4	3.4
	16	3.1	2.7	3.7	3.1	4.2	3.2	4.5	3.3	4.7	3.3	5.0	3.3	5.3	3.1
	18	3.1	2.7	3.7	3.1	4.2	3.2	4.5	3.3	4.7	3.3	5.0	3.3	5.3	3.1
	20	3.1	2.7	3.7	3.1	4.2	3.2	4.5	3.3	4.7	3.3	5.0	3.3	5.3	3.1
	21	3.1	2.7	3.7	3.1	4.2	3.2	4.5	3.3	4.7	3.3	5.0	3.3	5.3	3.1
	23	3.1	2.7	3.7	3.1	4.2	3.2	4.5	3.3	4.7	3.3	5.0	3.3	5.3	3.1
	25	3.1	2.7	3.7	3.1	4.2	3.2	4.5	3.3	4.7	3.3	5.0	3.3	5.3	3.1
	27	3.1	2.7	3.7	3.1	4.2	3.2	4.5	3.3	4.7	3.3	5.0	3.3	5.3	3.1
	29	3.1	2.7	3.7	3.1	4.2	3.2	4.5	3.3	4.7	3.3	5.0	3.3	5.3	3.1
	31	3.1	2.7	3.7	3.1	4.2	3.2	4.5	3.3	4.7	3.3	5.0	3.3	5.3	3.1
	33	3.1	2.7	3.7	3.1	4.2	3.2	4.5	3.3	4.7	3.3	5.0	3.3	5.3	3.1
	35	3.1	2.7	3.7	3.1	4.2	3.2	4.5	3.3	4.7	3.3	5.0	3.3	5.3	3.1
	37	3.1	2.7	3.7	3.1	4.2	3.2	4.5	3.3	4.6	3.2	4.9	3.2	5.2	3.1
39	3.1	2.7	3.7	3.1	4.2	3.2	4.5	3.3	4.6	3.2	4.9	3.2	5.1	3.0	
42	3.1	2.7	3.7	3.1	4.2	3.2	4.4	3.3	4.5	3.2	4.8	3.1	5.0	2.9	
44	3.1	2.7	3.7	3.1	4.1	3.1	4.3	3.2	4.4	3.1	4.6	3.0	4.8	2.8	
46	3.1	2.7	3.7	3.1	4.0	3.0	4.2	3.1	4.3	3.0	4.5	2.9	4.7	2.7	
48	3.1	2.6	3.6	3.0	3.9	3.0	4.0	3.0	4.2	2.9	4.3	2.8	4.5	2.6	
056	10	3.9	3.3	4.6	3.8	5.3	4.0	5.6	4.2	5.8	4.2	6.3	4.3	6.7	4.1
	12	3.9	3.3	4.6	3.8	5.3	4.0	5.6	4.2	5.8	4.2	6.3	4.3	6.7	4.1
	14	3.9	3.3	4.6	3.8	5.3	4.0	5.6	4.2	5.8	4.2	6.2	4.2	6.7	4.1
	16	3.9	3.3	4.6	3.8	5.3	4.0	5.6	4.2	5.8	4.2	6.2	4.2	6.6	4.0
	18	3.9	3.3	4.6	3.8	5.3	4.0	5.6	4.2	5.8	4.2	6.2	4.2	6.6	4.0
	20	3.9	3.3	4.6	3.8	5.3	4.0	5.6	4.2	5.8	4.2	6.2	4.2	6.6	4.0
	21	3.9	3.3	4.6	3.8	5.3	4.0	5.6	4.2	5.8	4.2	6.2	4.2	6.6	4.0
	23	3.9	3.3	4.6	3.8	5.3	4.0	5.6	4.2	5.8	4.2	6.2	4.2	6.6	4.0
	25	3.9	3.3	4.6	3.8	5.3	4.0	5.6	4.2	5.8	4.2	6.2	4.2	6.6	4.0
	27	3.9	3.3	4.6	3.8	5.3	4.0	5.6	4.2	5.8	4.2	6.2	4.2	6.6	4.0
	29	3.9	3.3	4.6	3.8	5.3	4.0	5.6	4.2	5.8	4.2	6.2	4.2	6.6	4.0
	31	3.9	3.3	4.6	3.8	5.3	4.0	5.6	4.2	5.8	4.2	6.2	4.2	6.6	4.0
	33	3.9	3.3	4.6	3.8	5.3	4.0	5.6	4.2	5.8	4.2	6.2	4.2	6.6	4.0
	35	3.9	3.3	4.6	3.8	5.3	4.0	5.6	4.2	5.8	4.2	6.2	4.2	6.6	4.0
	37	3.9	3.3	4.6	3.8	5.3	4.0	5.6	4.2	5.8	4.2	6.1	4.1	6.5	3.9
39	3.9	3.3	4.6	3.8	5.3	4.0	5.6	4.2	5.8	4.2	6.1	4.1	6.4	3.8	
42	3.9	3.3	4.6	3.8	5.3	4.0	5.5	4.1	5.7	4.2	6.0	4.0	6.2	3.7	
44	3.9	3.3	4.6	3.8	5.1	3.9	5.3	4.0	5.6	4.0	5.8	3.9	6.0	3.6	
46	3.9	3.3	4.6	3.7	5.0	3.8	5.2	3.9	5.4	3.9	5.6	3.7	5.9	3.5	
48	3.9	3.2	4.5	3.7	5.0	3.7	5.0	3.8	5.3	3.8	5.4	3.6	5.7	3.3	
071	10	4.9	4.3	5.8	5.0	6.7	5.2	7.1	5.4	7.4	5.6	8.0	5.7	8.5	5.4
	12	4.9	4.3	5.8	5.0	6.7	5.2	7.1	5.4	7.4	5.6	7.9	5.6	8.5	5.4
	14	4.9	4.3	5.8	5.0	6.7	5.2	7.1	5.4	7.4	5.6	7.9	5.6	8.5	5.4
	16	4.9	4.3	5.8	5.0	6.7	5.2	7.1	5.4	7.4	5.6	7.9	5.6	8.4	5.3
	18	4.9	4.3	5.8	5.0	6.7	5.2	7.1	5.4	7.4	5.6	7.9	5.6	8.4	5.3
	20	4.9	4.3	5.8	5.0	6.7	5.2	7.1	5.4	7.4	5.6	7.9	5.6	8.4	5.3
	21	4.9	4.3	5.8	5.0	6.7	5.2	7.1	5.4	7.4	5.6	7.9	5.6	8.4	5.3
	23	4.9	4.3	5.8	5.0	6.7	5.2	7.1	5.4	7.4	5.6	7.9	5.6	8.4	5.3
	25	4.9	4.3	5.8	5.0	6.7	5.2	7.1	5.4	7.4	5.6	7.9	5.6	8.4	5.3
	27	4.9	4.3	5.8	5.0	6.7	5.2	7.1	5.4	7.4	5.6	7.9	5.6	8.4	5.3
	29	4.9	4.3	5.8	5.0	6.7	5.2	7.1	5.4	7.4	5.6	7.9	5.6	8.4	5.3
	31	4.9	4.3	5.8	5.0	6.7	5.2	7.1	5.4	7.4	5.6	7.9	5.6	8.4	5.3
	33	4.9	4.3	5.8	5.0	6.7	5.2	7.1	5.4	7.4	5.6	7.9	5.6	8.4	5.3
	35	4.9	4.3	5.8	5.0	6.7	5.2	7.1	5.4	7.4	5.6	7.9	5.6	8.4	5.3
	37	4.9	4.3	5.8	5.0	6.7	5.2	7.1	5.4	7.3	5.5	7.8	5.5	8.2	5.2
39	4.9	4.3	5.8	5.0	6.7	5.2	7.1	5.4	7.3	5.5	7.7	5.4	8.1	5.1	
42	4.9	4.3	5.8	5.0	6.7	5.2	7.0	5.3	7.2	5.4	7.6	5.3	7.9	5.0	
44	4.9	4.3	5.8	5.0	6.5	5.0	6.8	5.2	7.0	5.3	7.3	5.1	7.6	4.8	
46	4.9	4.3	5.7	5.0	6.4	4.9	6.6	5.0	6.8	5.1	7.0	4.9	7.4	4.7	
48	4.8	4.2	5.7	4.9	6.3	4.9	6.4	4.9	6.7	5.0	6.8	4.8	7.2	4.5	

3. Capacity Table

Home DUCT

Heating

TC: Total Capacity

Capacity Index	Outdoor Air Temp. (°C)		Indoor temperature (°C,DB)				
			16(°C,DB)	18(°C,DB)	20(°C,DB)	22(°C,DB)	24(°C,DB)
	DB	WB	TC	TC	TC	TC	TC
045	-19.8	-20.0	3.1	3.1	2.9	2.9	2.9
	-18.8	-19.0	3.1	3.1	3.0	2.9	2.9
	-16.7	-17.0	3.2	3.2	3.1	3.0	3.0
	-14.7	-15.0	3.3	3.3	3.2	3.1	3.0
	-12.6	-13.0	3.5	3.4	3.4	3.3	3.2
	-10.5	-11.0	3.7	3.6	3.6	3.5	3.4
	-9.5	-10.0	3.7	3.6	3.6	3.5	3.5
	-8.5	-9.1	3.8	3.7	3.7	3.6	3.6
	-7.0	-7.6	3.9	3.8	3.8	3.7	3.6
	-5.0	-5.6	4.1	4.0	4.0	3.9	3.7
	-3.0	-3.7	4.3	4.2	4.2	4.0	3.9
	0.0	-0.7	4.5	4.4	4.4	4.2	4.0
	3.0	2.2	4.7	4.7	4.6	4.4	4.2
	5.0	4.1	4.9	4.9	4.8	4.5	4.2
	7.0	6.0	5.1	5.1	5.0	4.6	4.2
056	-19.8	-20.0	3.9	3.8	3.8	3.7	3.7
	-18.8	-19.0	3.9	3.9	3.8	3.7	3.7
	-16.7	-17.0	4.0	4.0	3.9	3.8	3.8
	-14.7	-15.0	4.2	4.1	4.0	3.9	3.8
	-12.6	-13.0	4.4	4.3	4.2	4.1	4.0
	-10.5	-11.0	4.6	4.5	4.4	4.4	4.3
	-9.5	-10.0	4.7	4.6	4.6	4.5	4.4
	-8.5	-9.1	4.8	4.7	4.7	4.6	4.5
	-7.0	-7.6	4.9	4.8	4.8	4.7	4.5
	-5.0	-5.6	5.2	5.1	5.0	4.9	4.7
	-3.0	-3.7	5.4	5.3	5.3	5.1	4.9
	0.0	-0.7	5.7	5.6	5.5	5.3	5.0
	3.0	2.2	5.9	5.9	5.8	5.6	5.3
	5.0	4.1	6.2	6.1	6.0	5.7	5.3
	7.0	6.0	6.5	6.4	6.3	5.8	5.3
071	-19.8	-20.0	4.9	4.9	4.8	4.7	4.7
	-18.8	-19.0	5.0	4.9	4.8	4.7	4.7
	-16.7	-17.0	5.1	5.0	4.9	4.8	4.8
	-14.7	-15.0	5.3	5.2	5.1	4.9	4.8
	-12.6	-13.0	5.5	5.4	5.3	5.2	5.1
	-10.5	-11.0	5.8	5.7	5.6	5.5	5.5
	-9.5	-10.0	6.0	5.9	5.8	5.7	5.6
	-8.5	-9.1	6.1	6.0	5.9	5.8	5.7
	-7.0	-7.6	6.2	6.1	6.0	5.9	5.8
	-5.0	-5.6	6.5	6.5	6.4	6.2	6.0
	-3.0	-3.7	6.9	6.8	6.7	6.4	6.2
	0.0	-0.7	7.2	7.1	7.0	6.7	6.4
	3.0	2.2	7.6	7.5	7.3	7.1	6.8
	5.0	4.1	7.9	7.8	7.7	7.2	6.8
	7.0	6.0	8.2	8.1	8.0	7.4	6.8

4. Dimensional Drawing

Home DUCT

AM045MNLDEH/EU, AM056MNLDEH/EU

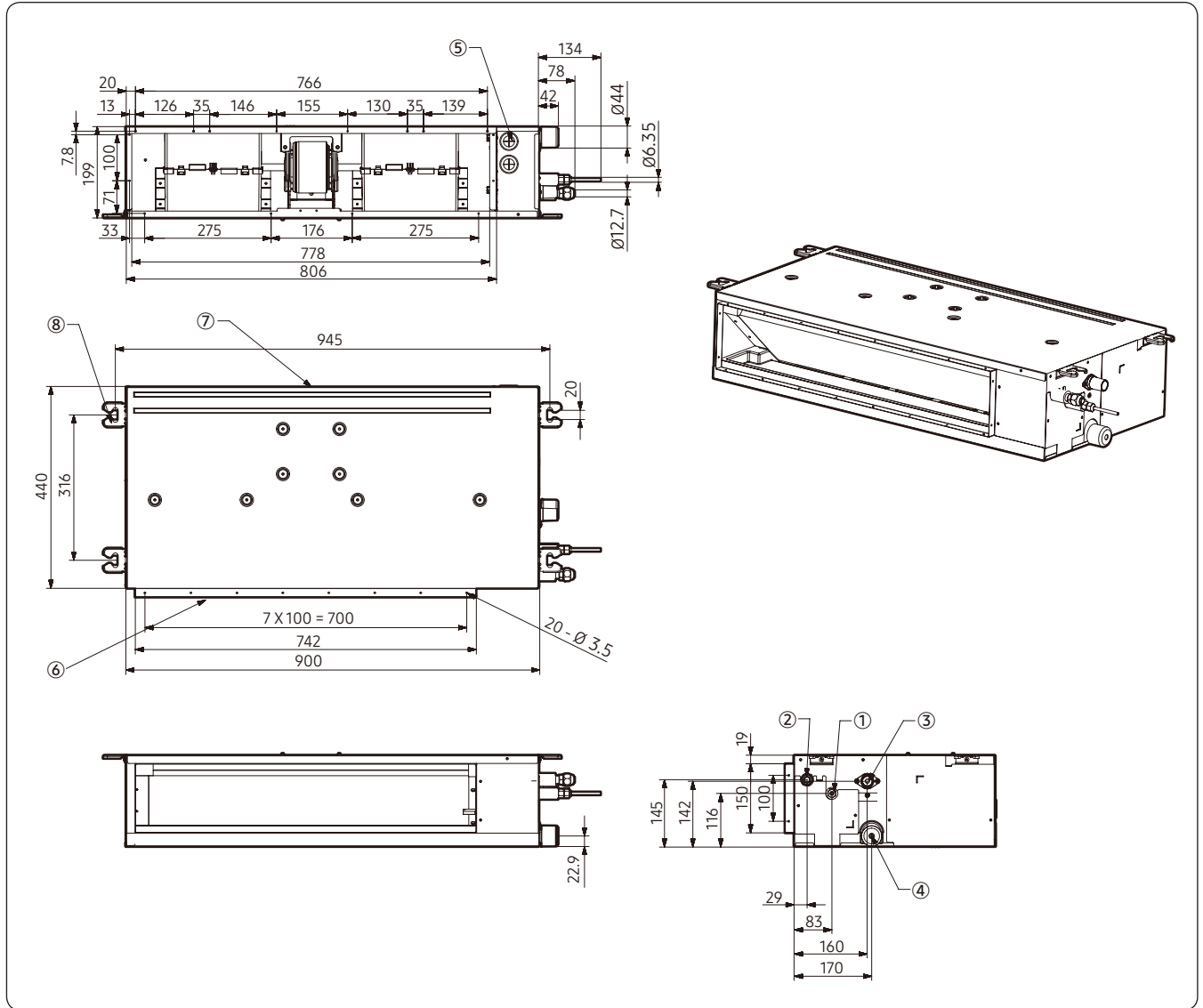

No.	Name	Description
①	Refrigerant Liquid Pipe	Ø6.35 [1/4"] Flare Connection
②	Refrigerant Gas Pipe	Ø12.70 [1/2"] Flare Connection
③	Condensate Drain	VP25 (OD 32, ID 25)
④	Condensate Drain (Option)	VP25 (OD 32, ID 25)
⑤	Power & Comm. Wiring Conduits	-
⑥	Supply Air Flange	-
⑦	Return Air Flange	-
⑧	Hook	-

4. Dimensional Drawing

Home DUCT

AM071MNLDEH/EU

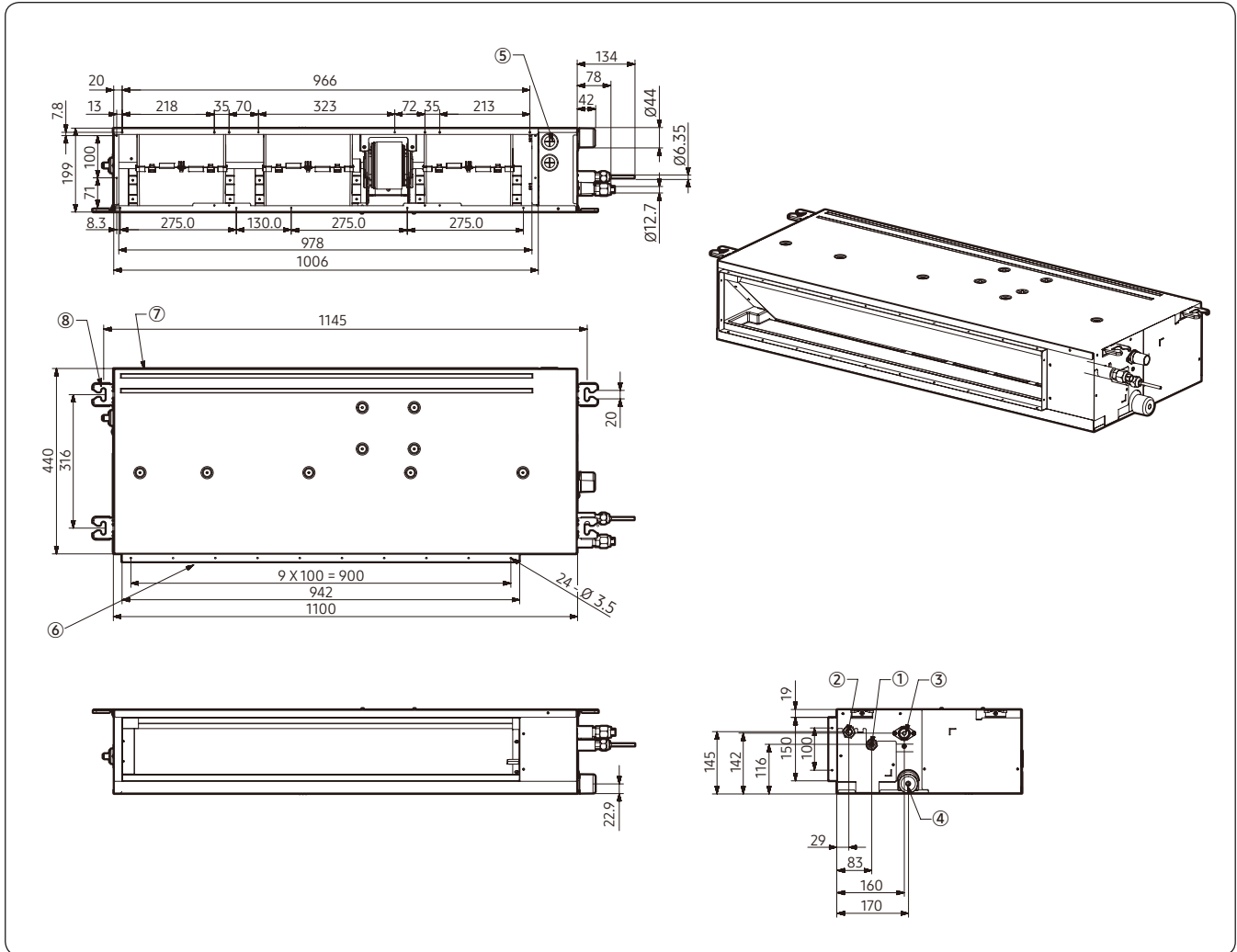

No.	Name	Description
①	Refrigerant Liquid Pipe	Ø9.52 [3/8"] Flare Connection
②	Refrigerant Gas Pipe	Ø15.88 [5/8"] Flare Connection
③	Condensate Drain	VP25 (OD 32, ID 25)
④	Condensate Drain (Option)	VP25 (OD 32, ID 25)
⑤	Power & Comm. Wiring Conduits	-
⑥	Supply Air Flange	-
⑦	Return Air Flange	-
⑧	Hook	-

5. Center of Gravity

Home DUCT

(Unit: mm)

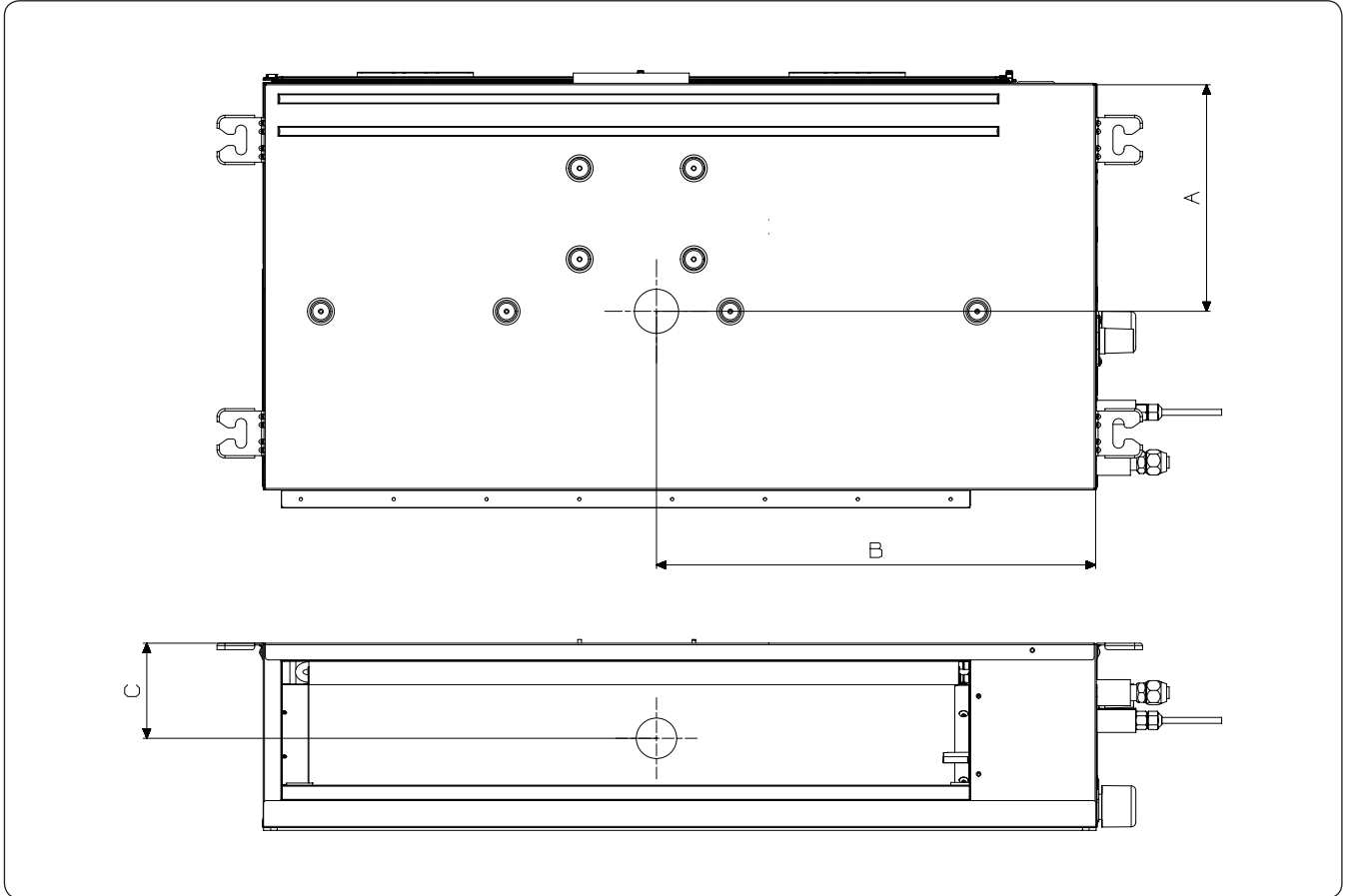

Model	A	B	C
4.5kW/5.6kW	233	436	100
7.1kW	240	540	100

6. Electrical Wiring Diagram

Home DUCT

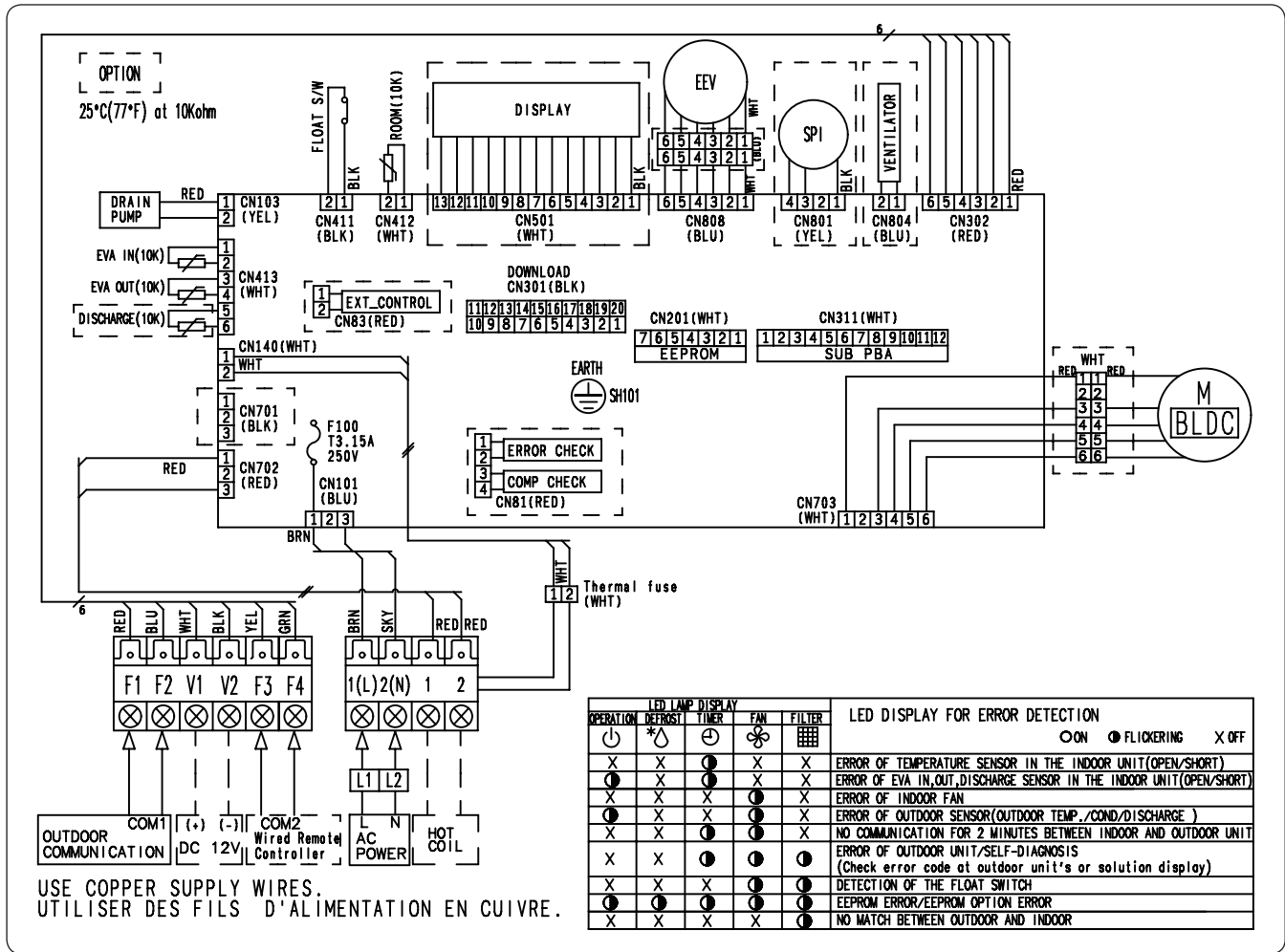

F100	FUSE	EEV	Electronic Expansion Valve	EVA-IN(10K)	Thermistor EVA IN(10K)
M[BLDC]	Motor (IDU fan)	SPI	S-Plasma ion	EVA-OUT(10K)	Thermistor EVA OUT(10K)
Thermal Fuse	Terminal Block Thermal Fuse	ROOM(10K)	Thermistor ROOM(10K)	DISCHARGE(10K)	Thermistor DISCHARGE(10K)

NOTE

- This wiring diagram applies only to the Indoor unit.
- Symbols show as follow :
blk: black, red: red, blu: blue, wht: white, yel: yellow, brn: brown, sky: skyblue: grn: green
- For connection wiring indoor-outdoor transmission F1-F2, indoor-wired remote controller transmission F3-F4.
- ⊕ Protective earth(screw), □□□□ : connector, $\frac{N}{\text{wire}}$: The wire quantity

7. Sound Data

Home DUCT

Sound pressure level

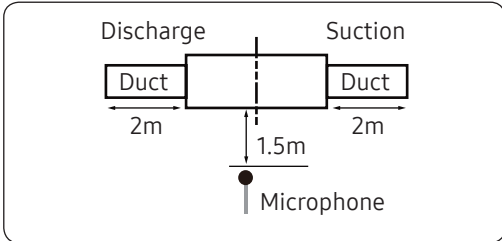

Unit: dB(A)

MODEL	High	Mid	Low
AM045MNLDEH/EU	32	28	25
AM056MNLDEH/EU	34	30	26
AM071MNLDEH/EU	34	30	27

• NR Curve

1) AM045MNLDEH/EU

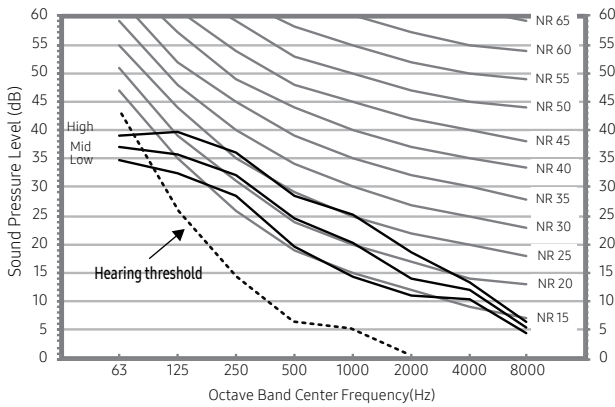

2) AM056MNLDEH/EU

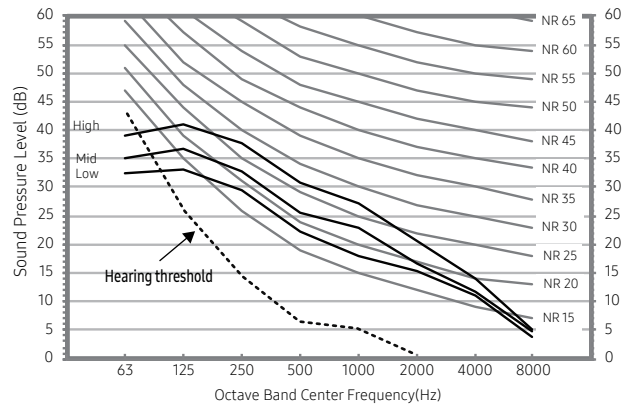

3) AM071MNLDEH/EU

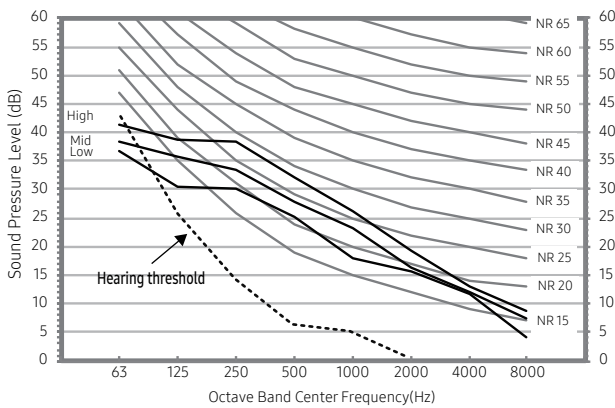

NOTE

- Specifications may be subject to change without prior notice.
 - Sound pressure level is obtained in an anechoic room.
 - Sound pressure level is a relative value, depending on the distance and acoustic environment.
 - Sound pressure level may differ depending on operation condition.
 - dBA = A weighted sound pressure level
 - Reference acoustic pressure 0 dB = 20μPa

7. Sound Data

Home DUCT

Sound Power level

NOTE

- Specifications may be subject to change without prior notice
 - Sound power level is an absolute value that a sound source generates.
 - dBA = A-weighted sound power level.
 - Reference power : 1pW.
 - Measured according to ISO 3741.

Unit: dB(A)

Model	Power
AM045MNLDEH/EU	47
AM056MNLDEH/EU	49
AM071MNLDEH/EU	49

• NR Curve

1) AM045MNLDEH/EU

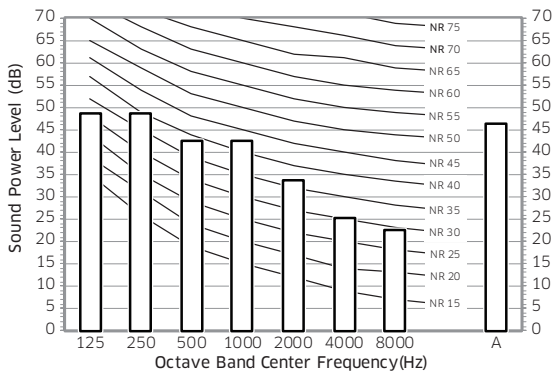

2) AM056MNLDEH/EU

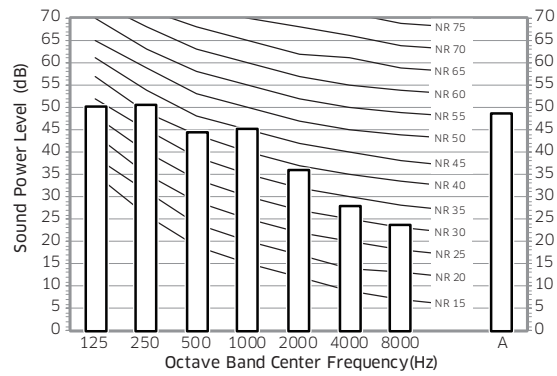

3) AM071MNLDEH/EU

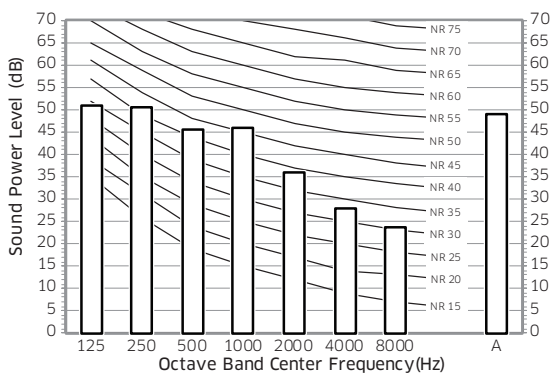

8. Fan Characteristics

Home DUCT

1) AM045MNLDEH

External Static Pressure(mmAq)	Option Code	Air Flow [CMM]		
		High	Mid	Low
0	010454-1C5458-202D2D-301110	7.5	10.0	12.5

External Static Pressure(mmAq)	Option Code
0 < P ≤ 2	010454-1C54EA-202D2D-301110

External Static Pressure(mmAq)	Option Code
2 < P ≤ 4	010454-1C585F-202D2D-301110

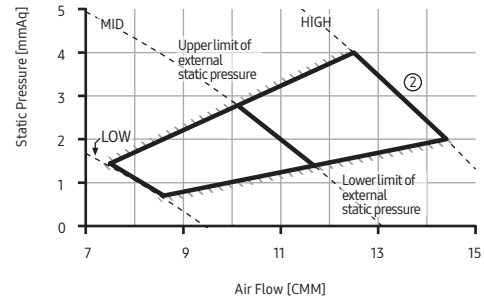
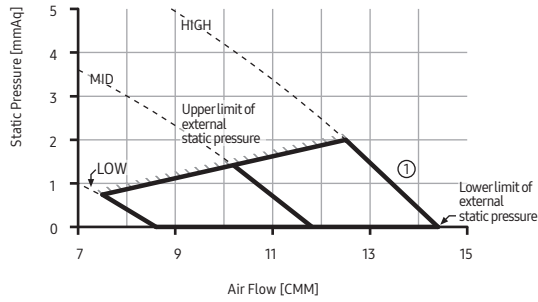

2) AM056MNLDEH

External Static Pressure(mmAq)	Option Code	Air Flow [CMM]		
		High	Mid	Low
0	010454-1C54FC-203838-301110	9.5	12.5	15.5

External Static Pressure(mmAq)	Option Code
0 < P ≤ 2	010454-1C5950-203838-301110

External Static Pressure(mmAq)	Option Code
2 < P ≤ 4	010454-1C59C4-203838-301110

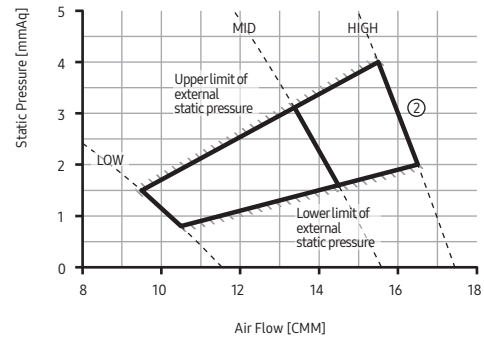
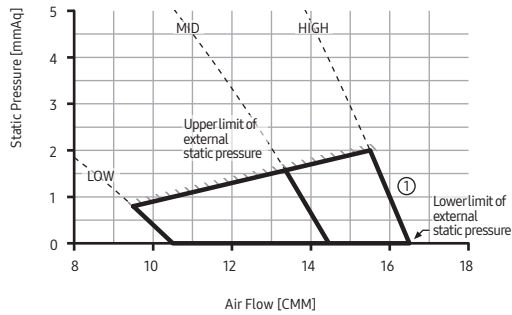

3) AM071MNLDEH

External Static Pressure(mmAq)	Option Code	Air Flow [CMM]		
		High	Mid	Low
0	010454-1C54D9-204747-301110	11.0	14.5	18.0

External Static Pressure(mmAq)	Option Code
0 < P ≤ 2	010454-1C584E-204747-301110

External Static Pressure(mmAq)	Option Code
2 < P ≤ 4	010454-1C59B2-204747-301110

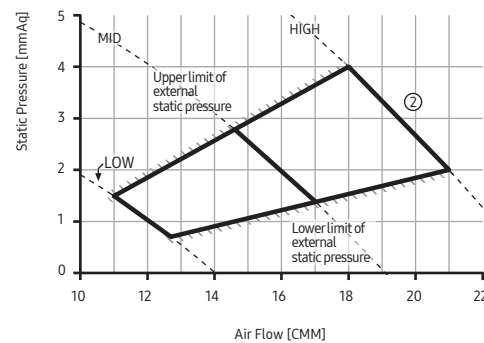
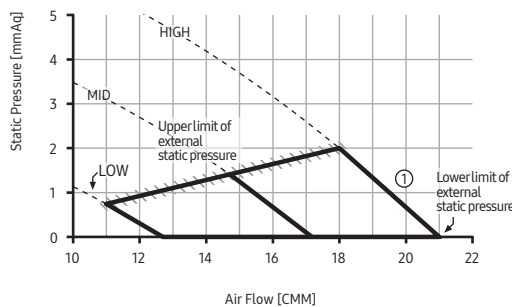

9. Piping Diagram

Home DUCT

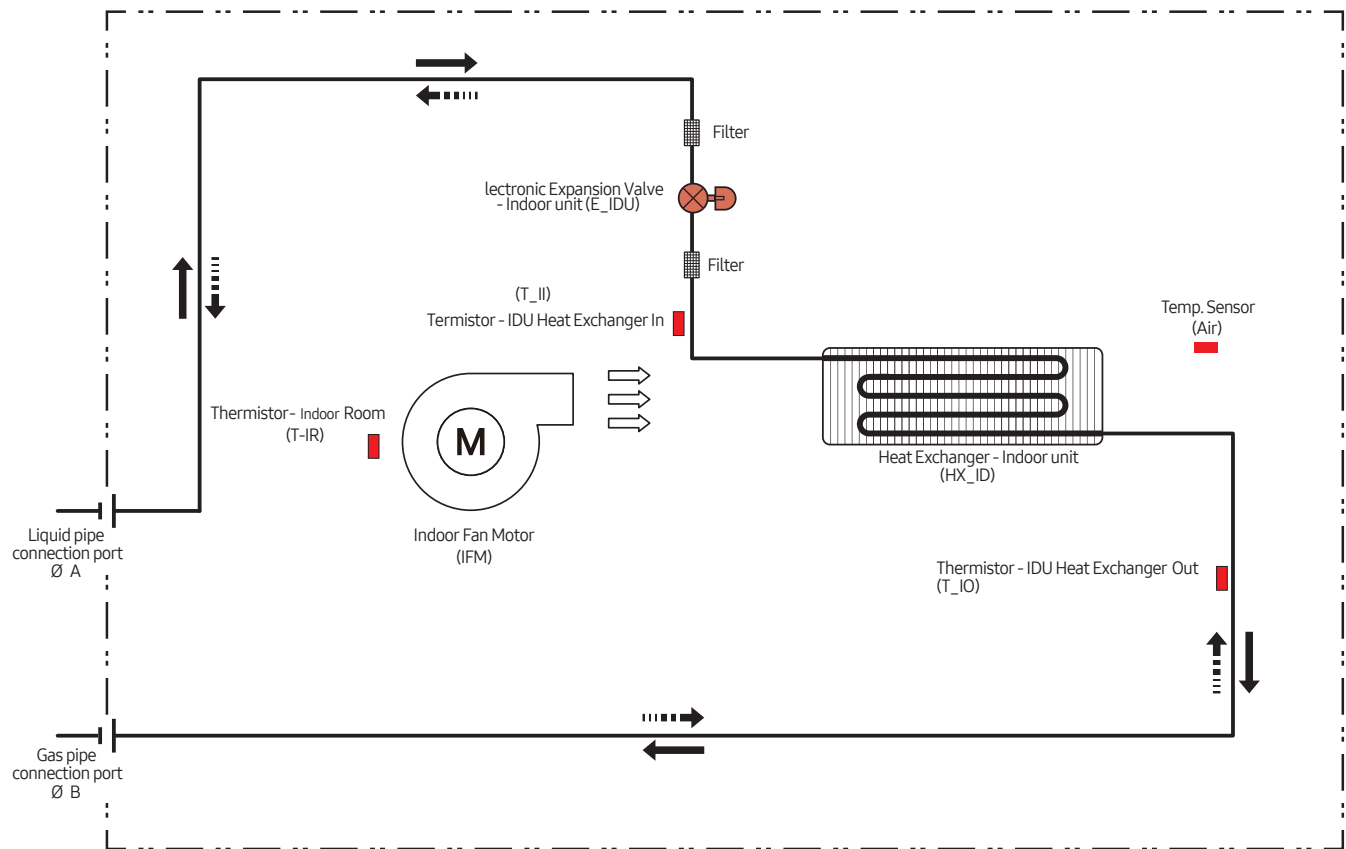

Refrigerant Flow	
Cooling	Heating

MODEL	A	B
AM045MNLDEH/EU	6.35	12.7
AM056MNLDEH/EU	6.35	12.7
AM071MNLDEH/EU	9.52	15.88

OAP Duct

- 1 *Specifications*
- 2 *Capacity Table*
- 3 *Dimensional Drawing*
- 4 *Electrical Wiring Diagram*
- 5 *Sound Pressure Level*
- 6 *Sound Power Level*
- 7 *Fan Characteristics*

1 Specifications

OAP Duct

Type			OAP Duct		OAP Duct		OAP Duct	
Model			AM140JNEPEH/EU		AM220JNEPEH/EU		AM280JNEPEH/EU	
Power Supply			Ø, #, V, Hz		1,2,220-240,50		1,2,220-240,50	
Mode			-		HP		HP	
Performance	Capacity (Nominal)	Cooling	kW	14.00	22.40	28.00		
			Btu/h	47,800	76,400	95,500		
		Heating	kW	8.90	13.90	17.40		
			Btu/h	30,400	47,400	59,400		
Power	Power Input (Nominal)	Cooling	W	220.00	300.00	370.00		
		Heating	W	220.00	300.00	370.00		
	Current Input (Nominal)	Cooling	A	1.60	2.20	3.00		
		Heating	A	1.60	2.20	3.00		
Fan	Motor	Type	-	Sirocco Fan	Sirocco Fan	Sirocco Fan		
		Output x n	w	183 x 1	400 x 1	400 x 1		
	Air Flow Rate	High	CMM	18.00	28.00	35.00		
			l/s	300.00	466.67	583.33		
	External Pressure	Min/Std/Max	mmAq	5.00 / 20.39 / 25.00	10.00 / 23.45 / 25.00	10.00 / 25.49 / 27.50		
			Pa	49.00 / 199.82 / 245.00	98.00 / 229.81 / 245.00	98.00 / 249.80 / 269.50		
Piping Connections	Liquid Pipe	Ø, mm	9.52	9.52	9.52			
		Ø, inch	3/8"	3/8"	3/8"			
	Gas Pipe	Ø, mm	15.88	19.05	22.22			
		Ø, inch	5/8"	3/4"	7/8"			
Drain Pipe	Ø, mm	VP25 (OD 32,ID 25)	VP25 (OD 32,ID 25)	VP25 (OD 32,ID 25)				
Field Wiring	Power Source Wire	mm ²	1.5 - 2.5	1.5 - 2.5	1.5 - 2.5			
	Transmission Cable	mm ²	0.75 - 1.50	0.75 - 1.50	0.75 - 1.50			
Refrigerant	Type	-	R410A	R410A	R410A			
	Control Method	-	EEV(O)	EEV(O)	EEV(O)			
Sound	Pressure	High	dB(A)	42	46	47		
	Power	Cooling		63	64	68		
Dimension	Net Weight		kg	51.0	85.0	85.0		
	Shipping Weight		kg	61.0	95.0	95.0		
	Net Dimensions (WxHxD)		mm	1,110 x 390 x 650	1,240 x 470 x 1,040	1,240 x 470 x 1,040		
	Shipping Dimensions (WxHxD)		mm	1,335 x 512 x 829	1,507 x 558 x 1,155	1,507 x 558 x 1,155		
Panel Size	Panel model		-	-	-	-		
	Panel Net Weight		kg	-	-	-		
	Shipping Weight		kg	-	-	-		
	Net Dimensions (WxHxD)		mm	-	-	-		
	Shipping Dimensions (WxHxD)		mm	-	-	-		
Additional Accessories	Drain Pump	Drain Pump	- / Model	MDP-N047SNC0D	MDP-N047SNC1D	MDP-N047SNC1D		
		Max. lifting Height / Displacement	mm/liter/h	-	-	-		
	Air Filter		-	-	-	-		

- Specifications may be subject to change without prior notice.

- Nominal cooling capacities are based on;

Outdoor temperature : 35°C DB, 28°C WB, Refrigerant pipe length : 7.5m, Level differences : 0m

Factory setting temperature for cooling mode : 18°C

- Nominal heating capacities are based on;

Outdoor temperature : 0°C DB, -2.9°C WB, Refrigerant pipe length : 7.5m, Level differences : 0m

Factory setting temperature for heating mode : 25°C

- Sound pressure was acquired in a dead room. Thus actual noise level may be different depending on the installation conditions.

- These products contain R410A which is fluorinated greenhouse gas.

* Heat Exchanger type : Fin & Tube (Fin : Al, Tube : Cu)

2 Capacity table

OAP Duct

1) Cooling

Capacity Index	Outdoor Air Temperature (°C, DB)	Outdoor Air Temperature (°C, WB)																	
		17		17		20		23		26		28		30		32		36	
		TC	SHC	TC	SHC	TC	SHC	TC	SHC	TC	SHC	TC	SHC	TC	SHC	TC	SHC	TC	SHC
140	20	3.7	2.7	3.9	2.3														
	22	3.7	2.9	3.9	2.5	5.2	2.1												
	25	3.7	3.0	3.9	2.6	5.2	2.6	6.8	2.6										
	27			3.8	3.3	5.2	3.4	6.8	3.4										
	29					5.2	4.2	6.8	4.1	11.1	4.2								
	31					5.1	4.8	6.7	4.8	11.1	4.9	14.2	5.0						
	33					5.1	5.1	6.7	5.5	11.0	5.6	14.0	5.6	16.3	5.3				
	35							6.7	6.3	11.0	6.4	14.0	6.4	16.2	5.9	17.5	5.3		
	37							6.6	6.6	10.8	6.8	13.3	6.8	15.2	6.2	16.3	5.6	16.8	3.7
	40									10.4	6.9	11.4	7.0	11.9	6.1	13.1	5.6	13.4	3.8
45									9.7	7.4	10.4	7.3	10.7	6.3	11.6	5.8	12.0	4.0	
224	20	5.7	4.2	6.1	3.5														
	22	5.7	4.4	6.1	3.8	8.2	3.3												
	25	5.7	4.6	6.1	4.1	8.2	4.1	10.8	4.2										
	27			6.1	5.2	8.1	5.3	10.7	5.3										
	29					8.1	6.4	10.5	6.4	17.6	6.6								
	31					8.0	7.5	10.5	7.6	17.6	7.7	22.6	7.8						
	33					8.0	8.0	10.6	8.7	17.5	8.9	22.4	9.0	26.2	8.5				
	35							10.6	9.8	17.5	10.0	22.4	10.2	26.2	9.5	27.8	8.3		
	37							10.6	10.5	17.2	10.7	21.4	10.8	24.4	9.8	16.1	8.8	26.8	5.8
	40									16.7	11.0	18.2	11.1	19.0	9.6	21.0	8.8	21.4	6.0
45									15.5	11.7	16.6	11.6	17.2	10.0	18.5	9.2	19.2	6.3	
280	20	7.1	5.2	7.6	4.4														
	22	7.1	5.5	7.6	4.8	10.3	4.1												
	25	7.1	5.8	7.6	5.1	10.2	5.2	13.5	5.2										
	27			7.6	6.5	10.1	6.6	13.4	6.6										
	29					10.1	8.0	13.4	8.1	22.0	8.2								
	31					10.0	9.4	13.3	9.5	21.9	9.7	28.2	9.8						
	33					10.0	10.0	13.3	10.9	21.9	11.1	28.0	11.2	32.8	10.6				
	35							13.2	12.3	21.8	12.5	28.0	12.7	32.7	11.8	34.8	10.4		
	37							13.2	13.2	21.6	13.4	26.7	13.6	30.5	12.3	32.7	11.1	33.5	7.3
	40									20.8	13.8	22.8	13.9	23.7	12.1	26.2	11.0	26.8	7.5
45									19.4	14.7	20.8	14.6	21.5	12.6	23.2	11.5	24.0	7.9	

2) Heating

Capacity Index	Outdoor Air Temperature (°C, DB)	Outdoor Air Temperature (°C, WB)									
		-7	-5	-2.9	0	2	4	6	10	14	
		TC	TC	TC	TC	TC	TC	TC	TC	TC	
140	-5	9.9	9.9								
	0			8.9							
	3			7.9	7.9	7.9					
	7					6.4	6.4	6.4			
	11						5.0	5.0	5.0		
	15							3.6	3.6	3.6	
140	-5	15.5	15.5								
	0			13.9							
	3			12.2	12.2	12.2					
	7					10.0	10.0	10.0			
	11						7.8	7.8	7.8		
	15							5.6	5.6	5.6	
140	-5	19.2	19.2								
	0			17.4							
	3			15.3	15.3	15.3					
	7					12.5	12.5	12.5			
	11						9.8	9.8	9.8		
	15							7.0	7.0	7.0	

- Capacity Table data may be subject to change without prior notice.
- Tested under following conditions
 - .Temperature setting for cooling : 18°C
 - .Temperature setting for heating : 25°C
- Heating capacity was tested under non-frost condition.

3 Dimensional drawing

OAP Duct

AM140JNEPEH/EU

Unit : mm

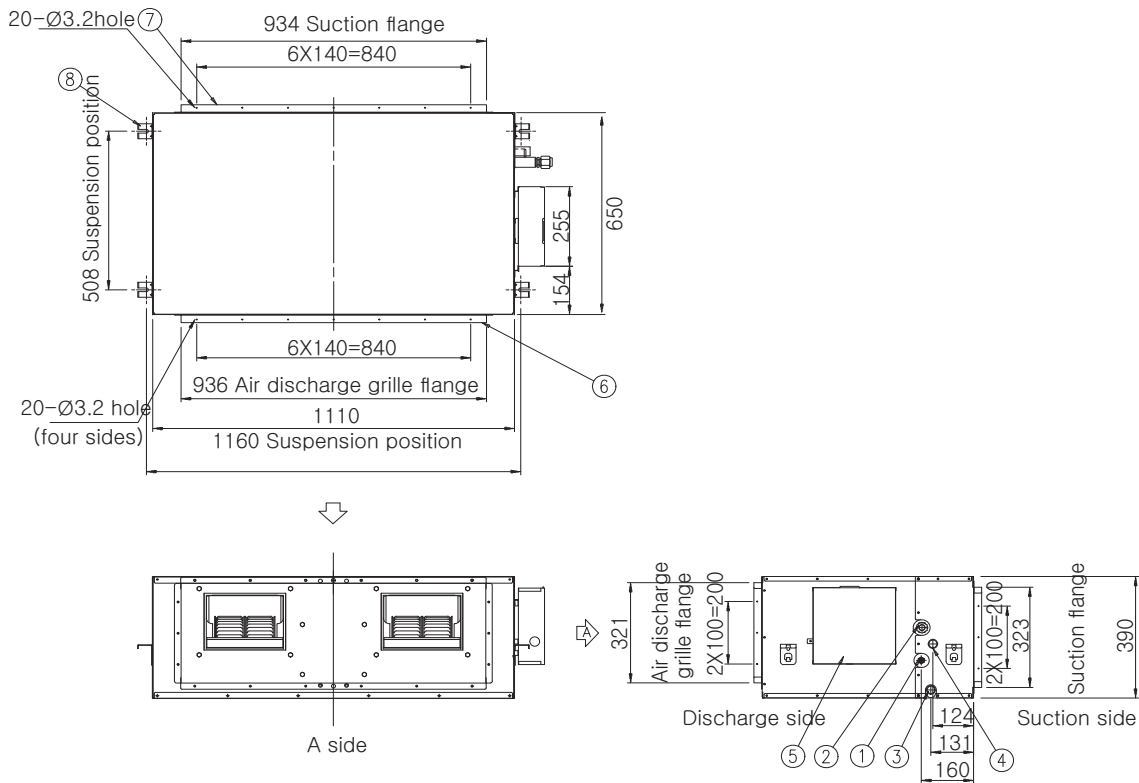

No.	Name	Description
1	Diameter of liquid pipe	ø9.52
2	Diameter of air pipe	ø15.88
3	Diameter of drain pipe	VP25 (OD ø32, ID ø25)
4	Diameter of drain pipe (Option drain pump)	VP25 (OD ø32, ID ø25)
5	Power supply / Communication connection	
6	Air discharge grille flange	
7	Suction flange	
8	Hook	ø9.52 or M10

3 Dimensional drawing

OAP Duct

AM220JNEPEH/EU, AM280JNEPEH/EU

Unit : mm

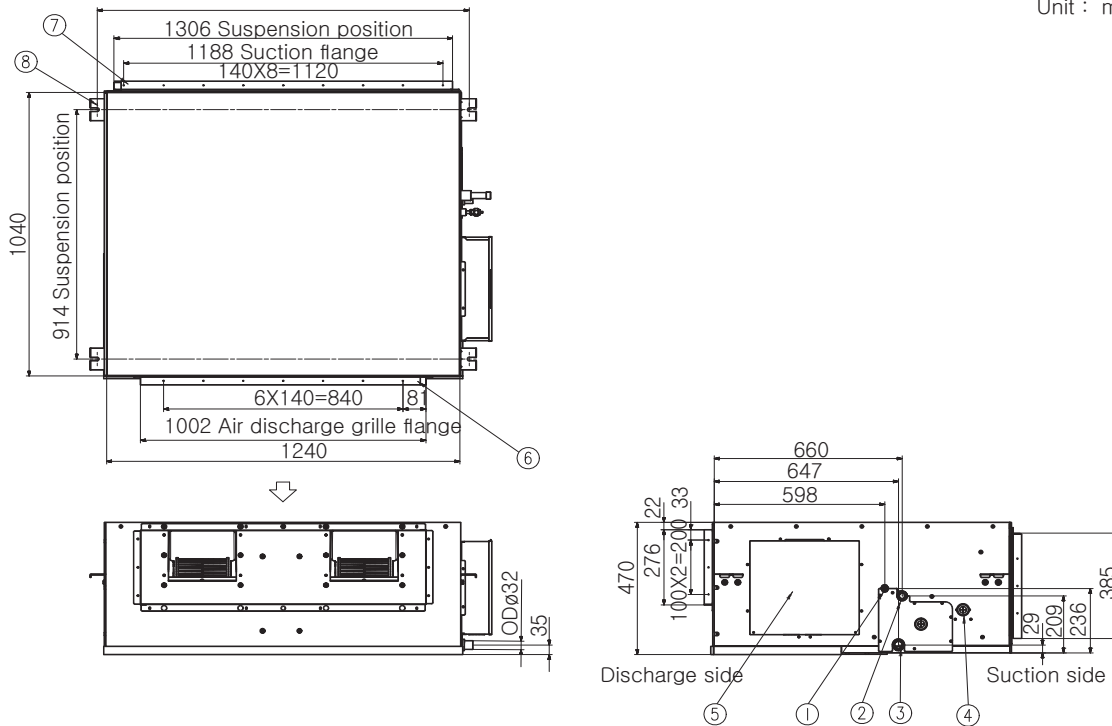

No.	Name	Description
1	Diameter of liquid pipe	ø9.52
2	Diameter of air pipe	ND220E** : ø19.05 ND280E** : ø22.22
3	Diameter of drain pipe	VP25 (OD ø32, ID ø25)
4	Diameter of drain pipe (Optional drain pump)	VP25 (OD ø32, ID ø25)
5	Power supply / Communication connection	
6	Air discharge grille flange	
7	Suction flange	
8	Hook	ø9.52 or M10

4 Electrical Wiring Diagram

OAP Duct

AM140JNEPEH/EU

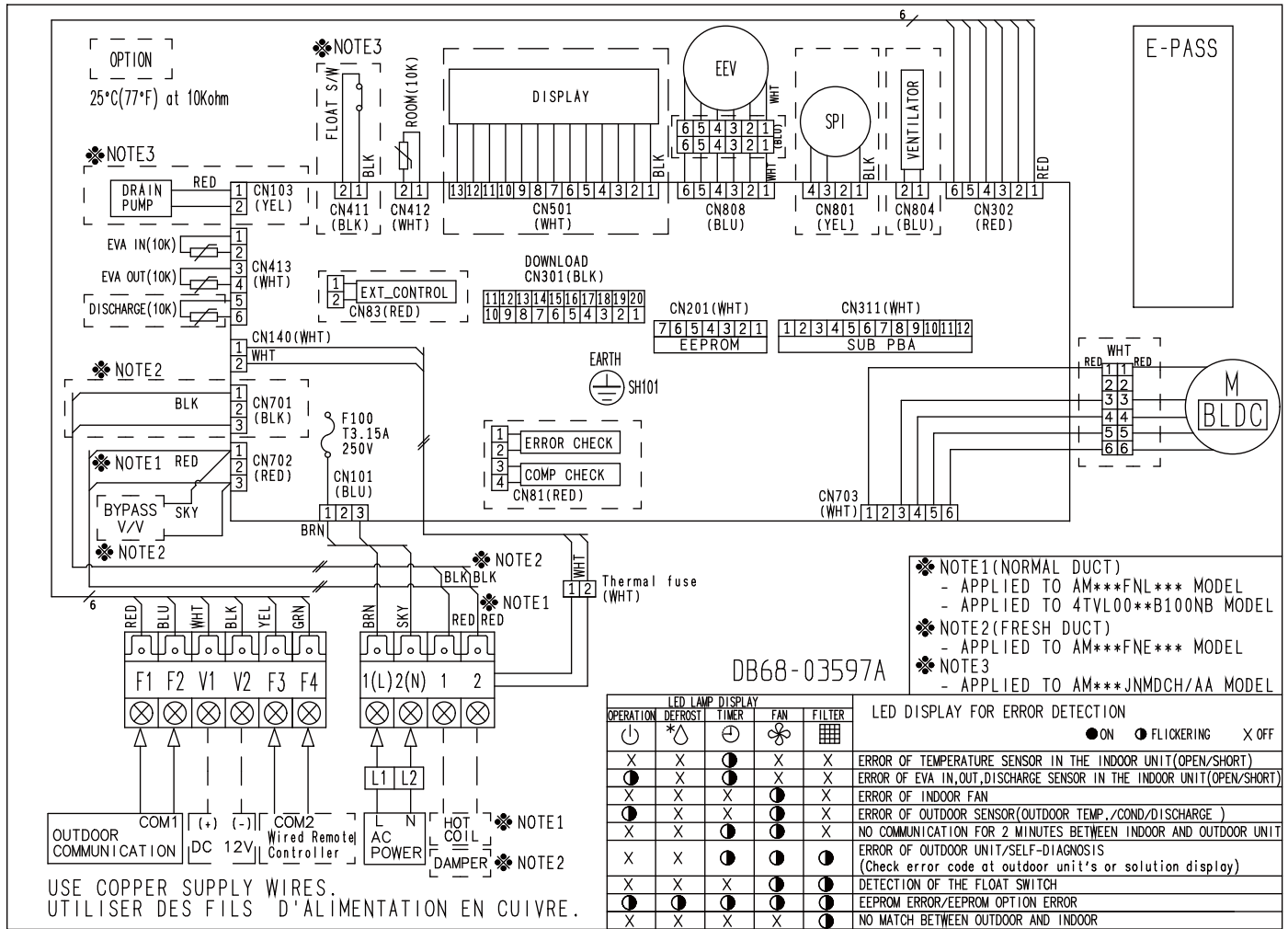

M [BLDC]	Motor (BLDC)	EEV	electronic expansion valve	EVA-IN(10K)	Thermistor EVA IN(10K)
DISCHARGE(10K)	Thermistor DISCHARGE(10K)	SPI	S-Plasma ion	EVA-OUT(10K)	Thermistor EVA OUT(10K)

NOTE

1. This wiring diagram applies only to the indoor unit.
2. Symbols show as follow;
 BLK : black, RED : red, BLU : blue, WHT:white, YEL : yellow, BRN : brown, SKY : sky-blue, GRN : green
3. For connection wiring indoor-outdoor transmission F1-F2, indoor-wired remotecontroller transmission F3-F4.
4. : Protective earth(screw), : Connector, n : The wire quantity

4 Electrical Wiring Diagram

OAP Duct

AM220/280JNEPEH/EU

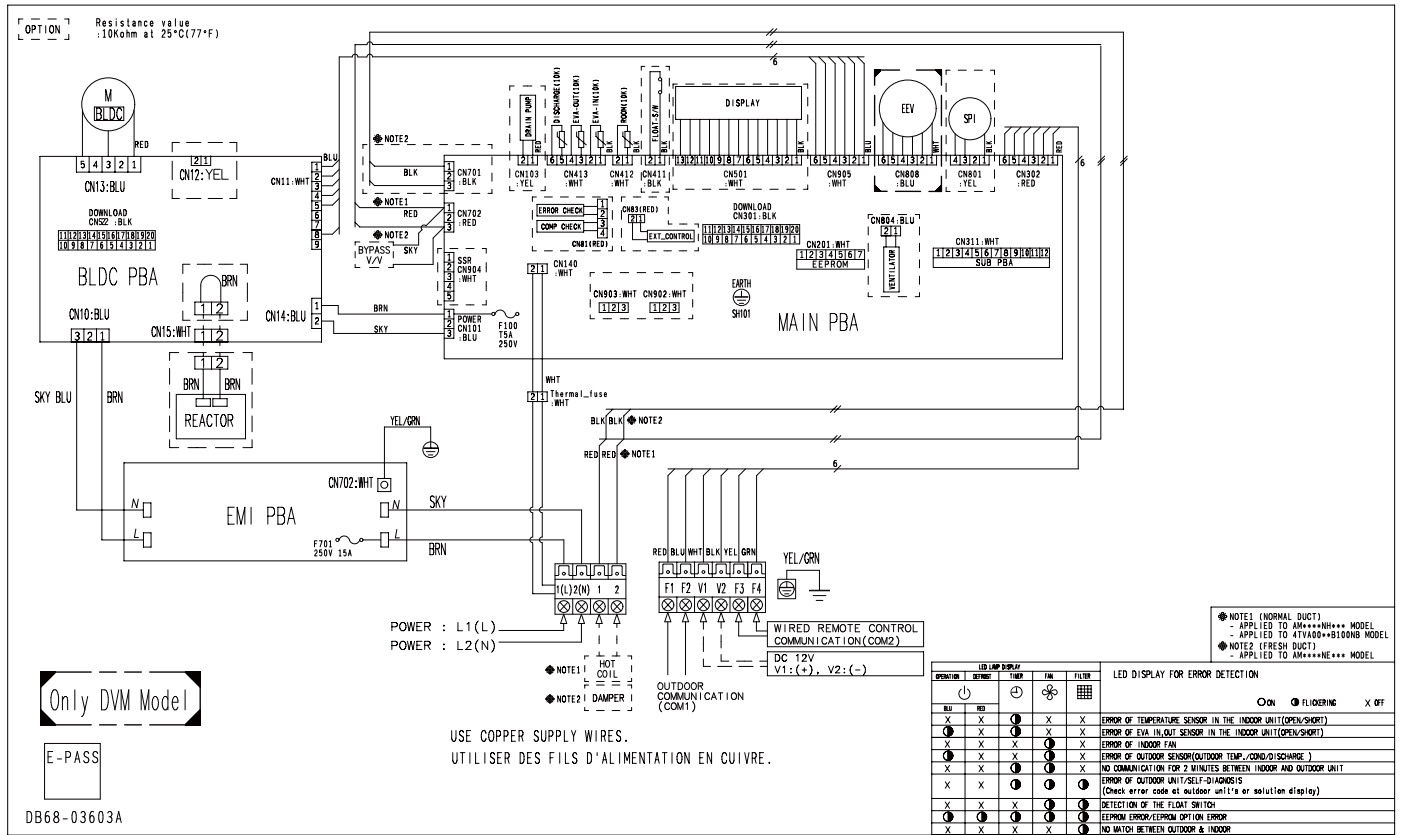

NOTE

1. This wiring diagram applies only to the indoor unit.
2. Symbols show as follow;
BLK : black, RED : red, BLU : blue, WHT:white, YEL : yellow, BRN : brown, SKY : sky-blue, GRN : green
3. For connection wiring indoor-outdoor transmission F1-F2, indoor-wired remotecontroller transmission F3-F4.
4. : Protective earth(screw), : Connector, n : The wire quantity

5 Sound pressure level

OAP Duct

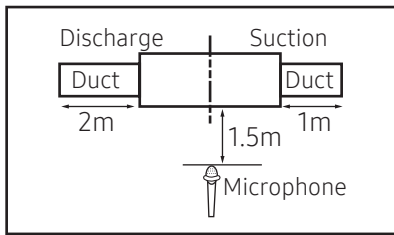

Unit: dB(A)	
Model	High
AM140JNEPEH/EU	42
AM220JNEPEH/EU	46
AM280JNEPEH/EU	47

Note

Specifications may be subject to change without prior notice.
 Sound pressure level is obtained in an anechoic room.
 Sound pressure level is a relative value, depending on the distance and acoustic environment.
 Sound pressure level may differ depending on operation condition.
 dBA = A-weighted sound pressure level
 Reference acoustic pressure 0 dB= 20 uPa

NR curves

1) AM140JNEPEH/EU

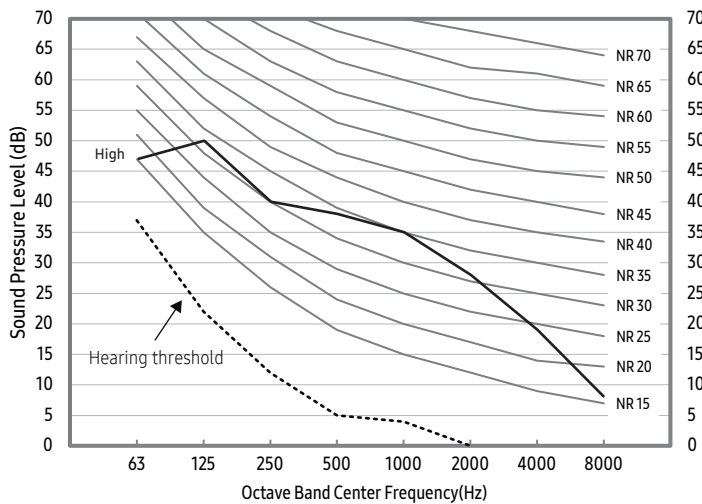

2) AM220JNEPEH/EU

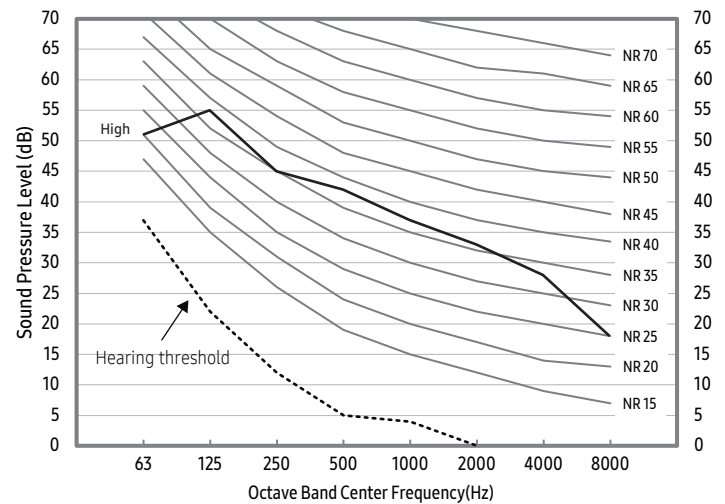

3) AM280JNEPEH/EU

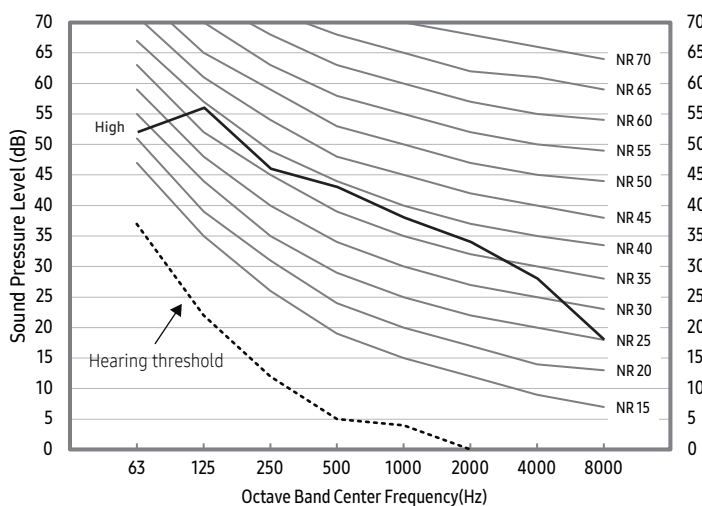

6 Sound power level

OAP Duct

Note

- . Specifications may be subject to change without prior notice.
- . Sound power level is an absolute value that a sound source generates.
- . dBA = A-weighted sound power level.
- . Reference power : 1pW.
- . Measured according to ISO 3741

Unit: dB(A)

Model	Power
AM140JNEPEH/EU	63
AM220JNEPEH/EU	64
AM280JNEPEH/EU	68

1)AM140JNEPEH/EU

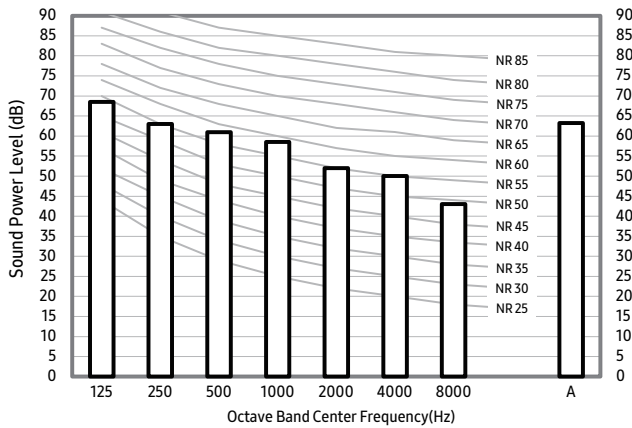

2)AM220JNEPEH/EU

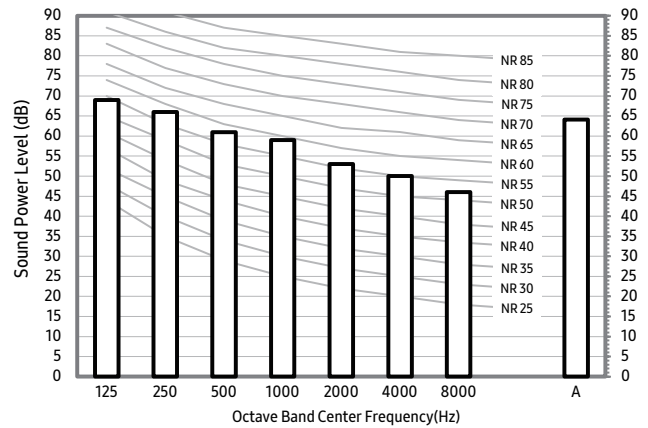

3)AM280JNEPEH/EU

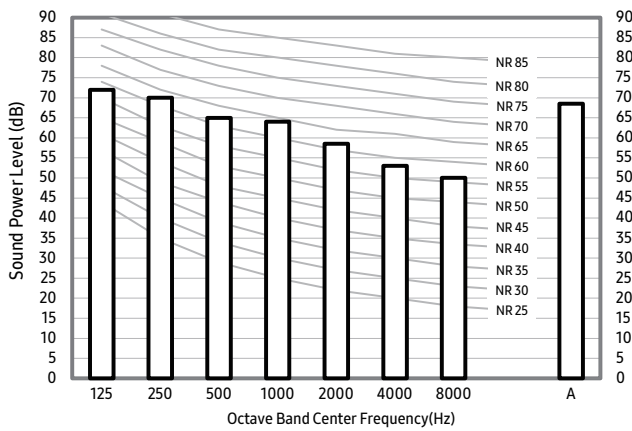

7 Fan Characteristics

OAP Duct

1) AM140JNEPEH/EU

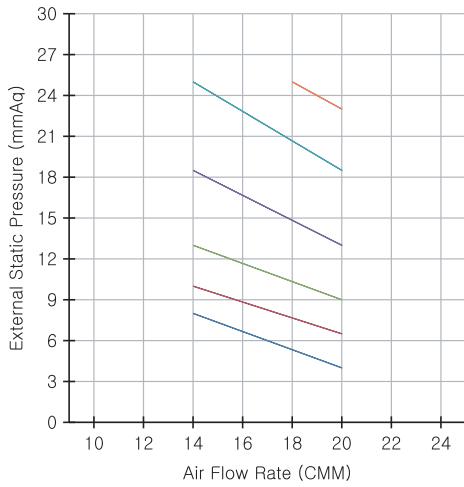

External Static Pressure (mmAq)	Option Code
4~8	01B064-1B490B-208C8C-333000
6.5~10	01B064-1B4A51-208C8C-333000
9~13	01B064-1B4AA6-208C8C-333000
13~18.5	01B064-1B4E2E-208C8C-333000
18.5~25	01B064-1B4F95-208C8C-333000
23~25	01B064-1B4FFB-208C8C-333000

2) AM220JNEPEH/EU

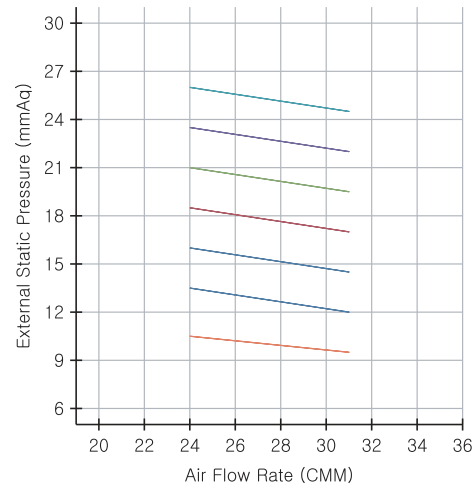

External Static Pressure (mmAq)	Option Code
9.5~10.5	01B064-194064-231616-333000
12~13.5	01B064-194075-231616-333000
14.5~16	01B064-1940CA-231616-333000
17~18.5	01B064-1940CA-231616-333000
19.5~21	01B064-1940EC-231616-333000
22~23.5	01B064-19441F-231616-333000
24.5~26	01B064-194530-231616-333000

3) AM280JNEPEH/EU

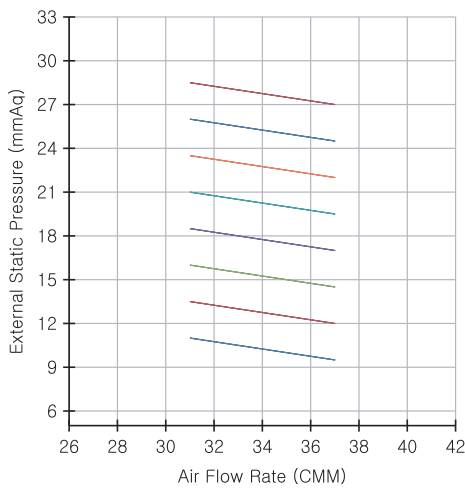

External Static Pressure (mmAq)	Option Code
9.5~10.5	01B064-194064-231C1C-333000
12~13.5	01B064-194086-231C1C-333000
14.5~16	01B064-1940A8-231C1C-333000
17~18.5	01B064-1940DB-231C1C-333000
19.5~21	01B064-19440E-231C1C-333000
22~23.5	01B064-194530-231C1C-333000
24.5~26	01B064-194550-231C1C-333000
27~28.5	01B064-194550-231C1C-333000

NOTE

1. ESP = External Static Pressuer
2. The graphs display the available external static pressure range of installed indoor units. Therefore, they do not reflect teh actual change of external static pressure and airflow rate according to adjusted airflow (High-Mid-Low) of installed indoor units.

Neo Forte

- 1 *Specifications*
- 2 *Capacity Table*
- 3 *Dimensional Drawing*
- 4 *Electrical Wiring Diagram*
- 5 *Sound Pressure Level*
- 6 *Sound Power Level*
- 7 *Temperature and air flow distribution*

1 Specifications

Neo Forte

Type			Neo Forte (EEV)		Neo Forte	
Model			AM015HNQDEH/EU		AM015HNTDEH/EU	
Power Supply			Ø, #, V, Hz	1,2,220-240,50	1,2,220-240,50	
Mode			-	HP/HR	HP/HR	
Performance	Capacity (Nominal)	Cooling	kW	1.50	1.50	
			Btu/h	5,100	5,100	
		Heating	kW	1.70	1.70	
			Btu/h	5,800	5,800	
Power	Power Input (Nominal)	Cooling	W	25.00	25.00	
		Heating		25.00	25.00	
	Current Input (Nominal)	Cooling	A	0.16	0.16	
		Heating		0.16	0.16	
Fan	Motor	Type	-	Crossflow Fan	Crossflow Fan	
		Output x n	w	23 x 1	23 x 1	
	Air Flow Rate	H/M/L (UL)	CMM	5.40 / 5.10 / 4.80	5.40 / 5.10 / 4.80	
			I/s	90.00 / 85.00 / 80.00	90.00 / 85.00 / 80.00	
	External Pressure	Min/Std/Max	mmAq	-	-	
Pa			-	-		
Piping Connections	Liquid Pipe	Ø, mm	6.35	6.35		
		Ø, inch	1/4"	1/4"		
	Gas Pipe	Ø, mm	12.70	12.70		
		Ø, inch	1/2"	1/2"		
Drain Pipe	Ø, mm	ID18 HOSE	ID18 HOSE			
Field Wiring	Power Source Wire	mm ²	1.5 - 2.5	1.5 - 2.5		
	Transmission Cable	mm ²	0.75 - 1.50	0.75 - 1.50		
Refrigerant	Type	-	R410A	R410A		
	Control Method	-	EEV INCLUDED	EEV NOT INCLUDED		
Sound	Pressure	High / Mid / Low	dB(A)	26 / 25 / 24	26 / 25 / 24	
	Power	Cooling		43	43	
Dimension	Net Weight		kg	8.3	8.0	
	Shipping Weight		kg	11.3	11.0	
	Net Dimensions (WxHxD)		mm	825 x 285 x 189	825 x 285 x 189	
	Shipping Dimensions (WxHxD)		mm	904 x 353 x 263	904 x 353 x 263	
Panel Size	Panel model		-	-	-	
	Panel Net Weight		kg	-	-	
	Shipping Weight		kg	-	-	
	Net Dimensions (WxHxD)		mm	-	-	
	Shipping Dimensions (WxHxD)		mm	-	-	
Additional Accessories	Drain Pump	Drain Pump	- / Model	-	-	
		Max. lifting Height / Displacement	mm/liter/h	-	-	
	Air Filter		-	-	-	

- Mode : HP(Heat Pump), HR(Heat Recovery)

- Nominal Cooling : Indoor temperature 27°CDB / 19°CWB, Outdoor temperature 35°CDB/24°CWB, Refrigerant pipe length 7.5m, Level difference 0m.

- Nominal Heating : Indoor temperature 20°CDB/15°CWB, Outdoor temperature 7°CDB / 6°CWB, Refrigerant pipe length 7.5m, Level difference 0m.

- Sound level was acquired in an anechoic room. Thus actual noise level may be different depending on the installation conditions.

- These products contain R410A which is fluorinated greenhouse gas.

- Specifications may be subject to change without prior notice.

* Heat Exchanger type : Fin & Tube (Fin : Al, Tube : Cu)

1 Specifications

Neo Forte

Type				Neo Forte (EEV)	Neo Forte
Model				AM022FNQDEH/EU	AM022FNTDEH/EU
Power Supply			Ø, #, V, Hz	1,2,220-240,50	1,2,220-240,50
Mode				HP/HR	HP/HR
Performance	Capacity (Nominal)	Cooling	kW	2.20	2.20
			Btu/h	7,500	7,500
		Heating	kW	2.50	2.50
			Btu/h	8,500	8,500
Power	Power Input (Nominal)	Cooling	W	25.00	25.00
		Heating	W	25.00	25.00
	Current Input (Nominal)	Cooling	A	0.16	0.16
		Heating	A	0.16	0.16
Fan	Motor	Type	-	Crossflow Fan	Crossflow Fan
		Output x n	w	23 x 1	23 x 1
	Air Flow Rate	H/M/L (UL)	CMM	7.80 / 6.80 / 5.80	7.80 / 6.80 / 5.80
			I/s	130.00 / 113.33 / 96.67	130.00 / 113.33 / 96.67
	External Pressure	Min/Std/Max	mmAq	-	-
Pa			-	-	
Piping Connections	Liquid Pipe		Ø, mm	6.35	6.35
			Ø, inch	1/4"	1/4"
	Gas Pipe		Ø, mm	12.70	12.70
			Ø, inch	1/2"	1/2"
	Drain Pipe		Ø, mm	ID18 HOSE	ID18 HOSE
Field Wiring	Power Source Wire		mm ²	1.5 - 2.5	1.5 - 2.5
	Transmission Cable		mm ²	0.75 - 1.50	0.75 - 1.50
Refrigerant	Type		-	R410A	R410A
	Control Method		-	EEV INCLUDED	EEV NOT INCLUDED
Sound	Pressure	High / Mid / Low	dB(A)	31 / 29 / 26	30 / 28 / 26
	Power	Cooling		49	48
Dimension	Net Weight		kg	8.3	8.0
	Shipping Weight		kg	11.3	11.0
	Net Dimensions (WxHxD)		mm	825 x 285 x 189	825 x 285 x 189
	Shipping Dimensions (WxHxD)		mm	904 x 353 x 263	904 x 353 x 263
Panel Size	Panel model		-	-	-
	Panel Net Weight		kg	-	-
	Shipping Weight		kg	-	-
	Net Dimensions (WxHxD)		mm	-	-
	Shipping Dimensions (WxHxD)		mm	-	-
Additional Accessories	Drain Pump	Drain Pump	- / Model	-	-
		Max. lifting Height / Displacement	mm/liter/h	-	-
	Air Filter		-	-	-

- Mode : HP(Heat Pump), HR(Heat Recovery)

- Nominal Cooling : Indoor temperature 27°CDB / 19°CWB, Outdoor temperature 35°CDB/24°CWB, Refrigerant pipe length 7.5m, Level difference 0m.

- Nominal Heating : Indoor temperature 20°CDB/15°CWB, Outdoor temperature 7°CDB / 6°CWB, Refrigerant pipe length 7.5m, Level difference 0m.

- Sound level was acquired in an anechoic room. Thus actual noise level may be different depending on the installation conditions.

- These products contain R410A which is fluorinated greenhouse gas.

- Specifications may be subject to change without prior notice.

* Heat Exchanger type : Fin & Tube (Fin : Al, Tube : Cu)

1 Specifications

Neo Forte

Type			Neo Forte (EEV)		Neo Forte	
Model			AM028FNQDEH/EU		AM028FNTDEH/EU	
Power Supply			Ø, #, V, Hz	1,2,220-240,50	1,2,220-240,50	
Mode			-	HP/HR	HP/HR	
Performance	Capacity (Nominal)	Cooling	kW	2.80	2.80	
			Btu/h	9,600	9,600	
		Heating	kW	3.20	3.20	
			Btu/h	10,900	10,900	
Power	Power Input (Nominal)	Cooling	W	25.00	25.00	
		Heating		25.00	25.00	
	Current Input (Nominal)	Cooling	A	0.16	0.16	
		Heating		0.16	0.16	
Fan	Motor	Type	-	Crossflow Fan	Crossflow Fan	
		Output x n	w	23 x 1	23 x 1	
	Air Flow Rate	H/M/L (UL)	CMM	7.80 / 6.80 / 5.80	7.80 / 6.80 / 5.80	
			I/s	130.00 / 113.33 / 96.67	130.00 / 113.33 / 96.67	
	External Pressure	Min/Std/Max	mmAq	-	-	
Pa			-	-		
Piping Connections	Liquid Pipe	Ø, mm	6.35	6.35		
		Ø, inch	1/4"	1/4"		
	Gas Pipe	Ø, mm	12.70	12.70		
		Ø, inch	1/2"	1/2"		
	Drain Pipe	Ø, mm	ID18 HOSE	ID18 HOSE		
Field Wiring	Power Source Wire	mm ²	1.5 - 2.5	1.5 - 2.5		
	Transmission Cable	mm ²	0.75 - 1.50	0.75 - 1.50		
Refrigerant	Type	-	R410A	R410A		
	Control Method	-	EEV INCLUDED	EEV NOT INCLUDED		
Sound	Pressure	High / Mid / Low	dB(A)	31 / 29 / 26	30 / 28 / 26	
	Power	Cooling		49	48	
Dimension	Net Weight		kg	8.3	8.0	
	Shipping Weight		kg	11.3	11.0	
	Net Dimensions (WxHxD)		mm	825 x 285 x 189	825 x 285 x 189	
	Shipping Dimensions (WxHxD)		mm	904 x 353 x 263	910 x 358 x 258	
Panel Size	Panel model		-	-	-	
	Panel Net Weight		kg	-	-	
	Shipping Weight		kg	-	-	
	Net Dimensions (WxHxD)		mm	-	-	
	Shipping Dimensions (WxHxD)		mm	-	-	
Additional Accessories	Drain Pump	Drain Pump	- / Model	-	-	
		Max. lifting Height / Displacement	mm/liter/h	-	-	
	Air Filter		-	-	-	

- Mode : HP(Heat Pump), HR(Heat Recovery)

- Nominal Cooling : Indoor temperature 27°CDB / 19°CWB, Outdoor temperature 35°CDB/24°CWB, Refrigerant pipe length 7.5m, Level difference 0m.

- Nominal Heating : Indoor temperature 20°CDB/15°CWB, Outdoor temperature 7°CDB / 6°CWB, Refrigerant pipe length 7.5m, Level difference 0m.

- Sound level was acquired in an anechoic room. Thus actual noise level may be different depending on the installation conditions.

- These products contain R410A which is fluorinated greenhouse gas.

- Specifications may be subject to change without prior notice.

* Heat Exchanger type : Fin & Tube (Fin : Al, Tube : Cu)

1 Specifications

Neo Forte

Type			Neo Forte (EEV)		Neo Forte	
Model			AM036FNQDEH/EU		AM036FNTDEH/EU	
Power Supply			Ø, #, V, Hz	1,2,220-240,50	1,2,220-240,50	
Mode			-	HP/HR	HP/HR	
Performance	Capacity (Nominal)	Cooling	kW	3.60	3.60	
			Btu/h	12,300	12,300	
		Heating	kW	4.00	4.00	
			Btu/h	13,600	13,600	
Power	Power Input (Nominal)	Cooling	W	30.00	30.00	
		Heating	W	30.00	30.00	
	Current Input (Nominal)	Cooling	A	0.18	0.18	
		Heating	A	0.18	0.18	
Fan	Motor	Type	-	Crossflow Fan	Crossflow Fan	
		Output x n	w	23 x 1	23 x 1	
	Air Flow Rate	H/M/L (UL)	CMM	9.30 / 8.30 / 7.30	9.30 / 8.30 / 7.30	
			I/s	155.00 / 138.33 / 121.67	155.00 / 138.33 / 121.67	
	External Pressure	Min/Std/Max	mmAq	-	-	
Pa			-	-		
Piping Connections	Liquid Pipe	Ø, mm	6.35	6.35		
		Ø, inch	1/4"	1/4"		
	Gas Pipe	Ø, mm	12.70	12.70		
		Ø, inch	1/2"	1/2"		
Drain Pipe	Ø, mm	ID18 HOSE	ID18 HOSE			
Field Wiring	Power Source Wire	mm ²	1.5 - 2.5	1.5 - 2.5		
	Transmission Cable	mm ²	0.75 - 1.50	0.75 - 1.50		
Refrigerant	Type	-	R410A	R410A		
	Control Method	-	EEV INCLUDED	EEV NOT INCLUDED		
Sound	Pressure	High / Mid / Low	dB(A)	37 / 33 / 29	36 / 32 / 28	
	Power	Cooling		54	53	
Dimension	Net Weight		kg	8.3	8.0	
	Shipping Weight		kg	11.3	11.0	
	Net Dimensions (WxHxD)		mm	825 x 285 x 189	825 x 285 x 189	
	Shipping Dimensions (WxHxD)		mm	904 x 353 x 263	910 x 358 x 258	
Panel Size	Panel model		-	-	-	
	Panel Net Weight		kg	-	-	
	Shipping Weight		kg	-	-	
	Net Dimensions (WxHxD)		mm	-	-	
	Shipping Dimensions (WxHxD)		mm	-	-	
Additional Accessories	Drain Pump	Drain Pump	- / Model	-	-	
		Max. lifting Height / Displacement	mm/liter/h	-	-	
	Air Filter		-	-	-	

- Mode : HP(Heat Pump), HR(Heat Recovery)

- Nominal Cooling : Indoor temperature 27°CDB / 19°CWB, Outdoor temperature 35°CDB/24°CWB, Refrigerant pipe length 7.5m, Level difference 0m.

- Nominal Heating : Indoor temperature 20°CDB/15°CWB, Outdoor temperature 7°CDB / 6°CWB, Refrigerant pipe length 7.5m, Level difference 0m.

- Sound level was acquired in an anechoic room. Thus actual noise level may be different depending on the installation conditions.

- These products contain R410A which is fluorinated greenhouse gas.

- Specifications may be subject to change without prior notice.

* Heat Exchanger type : Fin & Tube (Fin : Al, Tube : Cu)

1 Specifications

Neo Forte

Type			Neo Forte (EEV)		Neo Forte (EEV)		
Model			AM045FNQDEH/EU		AM056FNQDEH/EU		
Power Supply			Ø, #, V, Hz	1,2,220-240,50	1,2,220-240,50		
Mode			-	HP/HR	HP/HR		
Performance	Capacity (Nominal)	Cooling	kW	4.50	5.60		
			Btu/h	15,400	19,100		
		Heating	kW	5.00	6.30		
			Btu/h	17,100	21,500		
Power	Power Input (Nominal)	Cooling	W	40.00	45.00		
		Heating		40.00	45.00		
	Current Input (Nominal)	Cooling	A	0.24	0.27		
		Heating		0.24	0.27		
Fan	Motor	Type	-	Crossflow Fan	Crossflow Fan		
		Output x n	w	40 x 1	40 x 1		
	Air Flow Rate	H/M/L (UL)	CMM	11.70 / 10.20 / 8.70		13.00 / 10.50 / 9.00	
			I/s	195.00 / 170.00 / 145.00		216.67 / 175.00 / 150.00	
	External Pressure	Min/Std/Max	mmAq	-		-	
Pa			-		-		
Piping Connections	Liquid Pipe	Ø, mm	6.35		6.35		
		Ø, inch	1/4"		1/4"		
	Gas Pipe	Ø, mm	12.70		12.70		
		Ø, inch	1/2"		1/2"		
Drain Pipe	Ø, mm	ID18 HOSE		ID18 HOSE			
Field Wiring	Power Source Wire	mm ²	1.5 - 2.5		1.5 - 2.5		
	Transmission Cable	mm ²	0.75 - 1.50		0.75 - 1.50		
Refrigerant	Type	-	R410A		R410A		
	Control Method	-	EEV INCLUDED		EEV INCLUDED		
Sound	Pressure	High / Mid / Low	dB(A)	39 / 37 / 34		42 / 39 / 35	
	Power	Cooling		55		58	
Dimension	Net Weight		kg	13.5		13.5	
	Shipping Weight		kg	16.5		16.5	
	Net Dimensions (WxHxD)		mm	1,065 x 298 x 218		1,065 x 298 x 218	
	Shipping Dimensions (WxHxD)		mm	1,137 x 377 x 299		1,137 x 377 x 299	
Panel Size	Panel model		-	-		-	
	Panel Net Weight		kg	-		-	
	Shipping Weight		kg	-		-	
	Net Dimensions (WxHxD)		mm	-		-	
	Shipping Dimensions (WxHxD)		mm	-		-	
Additional Accessories	Drain Pump	Drain Pump	- / Model	-		-	
		Max. lifting Height / Displacement	mm/liter/h	-		-	
	Air Filter		-	-		-	

- Mode : HP(Heat Pump), HR(Heat Recovery)

- Nominal Cooling : Indoor temperature 27°CDB / 19°CWB, Outdoor temperature 35°CDB/24°CWB, Refrigerant pipe length 7.5m, Level difference 0m.

- Nominal Heating : Indoor temperature 20°CDB/15°CWB, Outdoor temperature 7°CDB / 6°CWB, Refrigerant pipe length 7.5m, Level difference 0m.

- Sound level was acquired in an anechoic room. Thus actual noise level may be different depending on the installation conditions.

- These products contain R410A which is fluorinated greenhouse gas.

- Specifications may be subject to change without prior notice.

* Heat Exchanger type : Fin & Tube (Fin : Al, Tube : Cu)

1 Specifications

Neo Forte

Type			Neo Forte		Neo Forte (EEV)		
Model			AM056FNTDEH/EU		AM071FNQDEH/EU		
Power Supply			Ø, #, V, Hz	1,2,220-240,50	1,2,220-240,50		
Mode			-	HP/HR	HP/HR		
Performance	Capacity (Nominal)	Cooling	kW	5.60	6.80		
			Btu/h	19,100	23,200		
		Heating	kW	6.30	7.00		
			Btu/h	21,500	23,900		
Power	Power Input (Nominal)	Cooling	W	45.00	50.00		
		Heating		45.00	50.00		
	Current Input (Nominal)	Cooling	A	0.27	0.30		
		Heating		0.27	0.30		
Fan	Motor	Type	-	Crossflow Fan			
		Output x n	w	40 x 1			
	Air Flow Rate	H/M/L (UL)	CMM	12.00 / 10.50 / 9.00		14.00 / 12.50 / 11.00	
			I/s	200.00 / 175.00 / 150.00		233.33 / 208.33 / 183.33	
	External Pressure	Min/Std/Max	mmAq	-		-	
Pa			-		-		
Piping Connections	Liquid Pipe	Ø, mm	6.35	9.52			
		Ø, inch	1/4"	3/8"			
	Gas Pipe	Ø, mm	12.70	15.88			
		Ø, inch	1/2"	5/8"			
Drain Pipe	Ø, mm	ID18 HOSE	ID18 HOSE				
Field Wiring	Power Source Wire	mm ²	1.5 - 2.5		1.5 - 2.5		
	Transmission Cable	mm ²	0.75 - 1.50		0.75 - 1.50		
Refrigerant	Type	-	R410A		R410A		
	Control Method	-	EEV NOT INCLUDED		EEV INCLUDED		
Sound	Pressure	High / Mid / Low	dB(A)	42 / 40 / 35		45 / 40 / 35	
	Power	Cooling		57		60	
Dimension	Net Weight		kg	13.0	13.5		
	Shipping Weight		kg	16.0	16.5		
	Net Dimensions (WxHxD)		mm	1,065 x 298 x 218		1,065 x 298 x 218	
	Shipping Dimensions (WxHxD)		mm	1,137 x 377 x 299		1,137 x 377 x 299	
Panel Size	Panel model		-	-	-		
	Panel Net Weight		kg	-	-		
	Shipping Weight		kg	-	-		
	Net Dimensions (WxHxD)		mm	-	-		
	Shipping Dimensions (WxHxD)		mm	-	-		
Additional Accessories	Drain Pump	Drain Pump	- / Model	-	-		
		Max. lifting Height / Displacement	mm/liter/h	-	-		
	Air Filter		-	-	-		

- Mode : HP(Heat Pump), HR(Heat Recovery)

- Nominal Cooling : Indoor temperature 27°CDB / 19°CWB, Outdoor temperature 35°CDB/24°CWB, Refrigerant pipe length 7.5m, Level difference 0m.

- Nominal Heating : Indoor temperature 20°CDB/15°CWB, Outdoor temperature 7°CDB / 6°CWB, Refrigerant pipe length 7.5m, Level difference 0m.

- Sound level was acquired in an anechoic room. Thus actual noise level may be different depending on the installation conditions.

- These products contain R410A which is fluorinated greenhouse gas.

- Specifications may be subject to change without prior notice.

* Heat Exchanger type : Fin & Tube (Fin : Al, Tube : Cu)

1 Specifications

Neo Forte

Type			Neo Forte		
Model			AM071FNTDEH/EU		
Power Supply		Ø, #, V, Hz	1,2,220-240,50		
Mode			- HP/HR		
Performance	Capacity (Nominal)	Cooling	kW	6.80	
			Btu/h	23,200	
		Heating	kW	7.00	
			Btu/h	23,900	
Power	Power Input (Nominal)	Cooling	W	50.00	
		Heating		50.00	
	Current Input (Nominal)	Cooling	A	0.30	
		Heating		0.30	
Fan	Motor	Type	Crossflow Fan		
		Output x n	w 40 x 1		
	Air Flow Rate	H/M/L (UL)	CMM	14.00 / 12.50 / 11.00	
			I/s	233.33 / 208.33 / 183.33	
	External Pressure	Min/Std/Max	mmAq	-	
Pa			-		
Piping Connections	Liquid Pipe	Ø, mm	9.52		
		Ø, inch	3/8"		
	Gas Pipe	Ø, mm	15.88		
		Ø, inch	5/8"		
	Drain Pipe	Ø, mm	ID18 HOSE		
Field Wiring	Power Source Wire	mm ²	1.5 - 2.5		
	Transmission Cable	mm ²	0.75 - 1.50		
Refrigerant	Type	-	R410A		
	Control Method	-	EEV NOT INCLUDED		
Sound	Pressure	High / Mid / Low	dB(A)	44 / 41 / 35	
	Power	Cooling		59	
Dimension	Net Weight		kg	13.0	
	Shipping Weight		kg	16.0	
	Net Dimensions (WxHxD)		mm	1,065 x 298 x 218	
	Shipping Dimensions (WxHxD)		mm	1,137 x 377 x 299	
Panel Size	Panel model		-	-	
	Panel Net Weight		kg	-	
	Shipping Weight		kg	-	
	Net Dimensions (WxHxD)		mm	-	
	Shipping Dimensions (WxHxD)		mm	-	
Additional Accessories	Drain Pump	Drain Pump	- / Model	-	
		Max. lifting Height / Displacement	mm/liter/h	-	
	Air Filter		-	-	

- Mode : HP(Heat Pump), HR(Heat Recovery)

- Nominal Cooling : Indoor temperature 27°CDB / 19°CWB, Outdoor temperature 35°CDB/24°CWB, Refrigerant pipe length 7.5m, Level difference 0m.

- Nominal Heating : Indoor temperature 20°CDB/15°CWB, Outdoor temperature 7°CDB / 6°CWB, Refrigerant pipe length 7.5m, Level difference 0m.

- Sound level was acquired in an anechoic room. Thus actual noise level may be different depending on the installation conditions.

- These products contain R410A which is fluorinated greenhouse gas.

- Specifications may be subject to change without prior notice.

* Heat Exchanger type : Fin & Tube (Fin : Al, Tube : Cu)

2 Capacity table

Neo Forte

Cooling

TC : Total Capacity, SHC : Sensible Heat Capacity

Capacity Index	Outdoor Air Temp. (°C, DB)	Indoor temperature													
		20(°C, DB)		23(°C, DB)		26(°C, DB)		27(°C, DB)		28(°C, DB)		30(°C, DB)		32(°C, DB)	
		14(°C, WB)		16(°C, WB)		18(°C, WB)		19(°C, WB)		20(°C, WB)		22(°C, WB)		24(°C, WB)	
		TC	SHC	TC	SHC	TC	SHC	TC	SHC	TC	SHC	TC	SHC	TC	SHC
015	10	1.0	0.9	1.2	1.0	1.4	1.0	1.5	1.0	1.6	1.0	1.7	1.1	1.8	1.0
	12	1.0	0.9	1.2	1.0	1.4	1.0	1.5	1.0	1.6	1.0	1.7	1.1	1.8	1.0
	14	1.0	0.9	1.2	1.0	1.4	1.0	1.5	1.0	1.6	1.0	1.7	1.1	1.8	1.0
	16	1.0	0.9	1.2	1.0	1.4	1.0	1.5	1.0	1.6	1.0	1.6	1.1	1.8	1.0
	18	1.0	0.9	1.2	1.0	1.4	1.0	1.5	1.0	1.6	1.0	1.6	1.1	1.8	1.0
	20	1.0	0.9	1.2	1.0	1.4	1.0	1.5	1.0	1.6	1.0	1.6	1.1	1.8	1.0
	21	1.0	0.9	1.2	1.0	1.4	1.0	1.5	1.0	1.6	1.0	1.6	1.1	1.8	1.0
	23	1.0	0.9	1.2	1.0	1.4	1.0	1.5	1.0	1.6	1.0	1.6	1.1	1.8	1.0
	25	1.0	0.9	1.2	1.0	1.4	1.0	1.5	1.0	1.6	1.0	1.6	1.1	1.8	1.0
	27	1.0	0.9	1.2	1.0	1.4	1.0	1.5	1.0	1.6	1.0	1.6	1.1	1.8	1.0
	29	1.0	0.9	1.2	1.0	1.4	1.0	1.5	1.0	1.6	1.0	1.6	1.1	1.8	1.0
	31	1.0	0.9	1.2	1.0	1.4	1.0	1.5	1.0	1.6	1.0	1.6	1.1	1.8	1.0
	33	1.0	0.9	1.2	1.0	1.4	1.0	1.5	1.0	1.6	1.0	1.6	1.1	1.8	1.0
	35	1.0	0.9	1.2	1.0	1.4	1.0	1.5	1.0	1.6	1.0	1.6	1.1	1.8	1.0
	37	1.0	0.9	1.2	1.0	1.4	1.0	1.5	1.0	1.6	1.0	1.6	1.1	1.8	1.0
39	1.0	0.9	1.2	1.0	1.4	1.0	1.5	1.0	1.6	1.0	1.6	1.1	1.7	0.9	
42	1.0	0.9	1.2	1.0	1.4	1.0	1.5	1.0	1.6	1.0	1.6	1.1	1.7	0.9	
44	1.0	0.9	1.2	1.0	1.4	1.0	1.4	1.0	1.5	1.0	1.5	1.0	1.6	0.8	
46	1.0	0.9	1.2	1.0	1.3	1.0	1.4	0.9	1.5	0.9	1.5	1.0	1.6	0.8	
48	1.0	0.9	1.2	1.0	1.3	0.9	1.3	0.9	1.5	0.9	1.4	1.0	1.5	0.8	
022	10	1.5	1.3	1.8	1.5	2.1	1.5	2.2	1.5	2.3	1.5	2.5	1.6	2.6	1.4
	12	1.5	1.3	1.8	1.5	2.1	1.5	2.2	1.5	2.3	1.5	2.5	1.6	2.6	1.4
	14	1.5	1.3	1.8	1.5	2.1	1.5	2.2	1.5	2.3	1.5	2.5	1.6	2.6	1.4
	16	1.5	1.3	1.8	1.5	2.1	1.5	2.2	1.5	2.3	1.5	2.4	1.5	2.6	1.4
	18	1.5	1.3	1.8	1.5	2.1	1.5	2.2	1.5	2.3	1.5	2.4	1.5	2.6	1.4
	20	1.5	1.3	1.8	1.5	2.1	1.5	2.2	1.5	2.3	1.5	2.4	1.5	2.6	1.4
	21	1.5	1.3	1.8	1.5	2.1	1.5	2.2	1.5	2.3	1.5	2.4	1.5	2.6	1.4
	23	1.5	1.3	1.8	1.5	2.1	1.5	2.2	1.5	2.3	1.5	2.4	1.5	2.6	1.4
	25	1.5	1.3	1.8	1.5	2.1	1.5	2.2	1.5	2.3	1.5	2.4	1.5	2.6	1.4
	27	1.5	1.3	1.8	1.5	2.1	1.5	2.2	1.5	2.3	1.5	2.4	1.5	2.6	1.4
	29	1.5	1.3	1.8	1.5	2.1	1.5	2.2	1.5	2.3	1.5	2.4	1.5	2.6	1.4
	31	1.5	1.3	1.8	1.5	2.1	1.5	2.2	1.5	2.3	1.5	2.4	1.5	2.6	1.4
	33	1.5	1.3	1.8	1.5	2.1	1.5	2.2	1.5	2.3	1.5	2.4	1.5	2.6	1.4
	35	1.5	1.3	1.8	1.5	2.1	1.5	2.2	1.5	2.3	1.5	2.4	1.5	2.6	1.4
	37	1.5	1.3	1.8	1.5	2.1	1.5	2.2	1.5	2.3	1.5	2.4	1.5	2.6	1.4
39	1.5	1.3	1.8	1.5	2.1	1.5	2.2	1.5	2.3	1.5	2.4	1.5	2.5	1.3	
42	1.5	1.3	1.8	1.5	2.1	1.5	2.2	1.5	2.3	1.5	2.4	1.5	2.4	1.3	
44	1.5	1.3	1.8	1.5	2.0	1.4	2.1	1.4	2.2	1.4	2.3	1.4	2.4	1.2	
46	1.5	1.3	1.8	1.5	2.0	1.4	2.0	1.4	2.1	1.4	2.2	1.4	2.3	1.2	
48	1.5	1.3	1.8	1.5	2.0	1.4	2.0	1.3	2.1	1.4	2.1	1.3	2.2	1.1	
028	10	1.9	1.6	2.3	1.8	2.6	2.0	2.8	1.9	2.9	1.9	3.1	1.9	3.4	1.9
	12	1.9	1.6	2.3	1.8	2.6	2.0	2.8	1.9	2.9	1.9	3.1	1.9	3.3	1.8
	14	1.9	1.6	2.3	1.8	2.6	2.0	2.8	1.9	2.9	1.9	3.1	1.9	3.3	1.8
	16	1.9	1.6	2.3	1.8	2.6	2.0	2.8	1.9	2.9	1.9	3.1	1.9	3.3	1.8
	18	1.9	1.6	2.3	1.8	2.6	2.0	2.8	1.9	2.9	1.9	3.1	1.9	3.3	1.8
	20	1.9	1.6	2.3	1.8	2.6	2.0	2.8	1.9	2.9	1.9	3.1	1.9	3.3	1.8
	21	1.9	1.6	2.3	1.8	2.6	2.0	2.8	1.9	2.9	1.9	3.1	1.9	3.3	1.8
	23	1.9	1.6	2.3	1.8	2.6	2.0	2.8	1.9	2.9	1.9	3.1	1.9	3.3	1.8
	25	1.9	1.6	2.3	1.8	2.6	2.0	2.8	1.9	2.9	1.9	3.1	1.9	3.3	1.8
	27	1.9	1.6	2.3	1.8	2.6	2.0	2.8	1.9	2.9	1.9	3.1	1.9	3.3	1.8
	29	1.9	1.6	2.3	1.8	2.6	2.0	2.8	1.9	2.9	1.9	3.1	1.9	3.3	1.8
	31	1.9	1.6	2.3	1.8	2.6	2.0	2.8	1.9	2.9	1.9	3.1	1.9	3.3	1.8
	33	1.9	1.6	2.3	1.8	2.6	2.0	2.8	1.9	2.9	1.9	3.1	1.9	3.3	1.8
	35	1.9	1.6	2.3	1.8	2.6	2.0	2.8	1.9	2.9	1.9	3.1	1.9	3.3	1.8
	37	1.9	1.6	2.3	1.8	2.6	2.0	2.8	1.9	2.9	1.9	3.1	1.9	3.3	1.8
39	1.9	1.6	2.3	1.8	2.6	2.0	2.8	1.9	2.9	1.9	3.0	1.8	3.2	1.7	
42	1.9	1.6	2.3	1.8	2.6	2.0	2.8	1.9	2.9	1.9	2.9	1.8	3.1	1.7	
44	1.9	1.6	2.3	1.8	2.5	1.9	2.7	1.8	2.8	1.8	2.8	1.7	3.0	1.6	
46	1.9	1.6	2.3	1.8	2.5	1.9	2.6	1.8	2.7	1.8	2.7	1.6	2.9	1.6	
48	1.9	1.6	2.2	1.8	2.4	1.9	2.5	1.7	2.6	1.7	2.7	1.6	2.8	1.5	

2 Capacity table

Neo Forte

Cooling

TC : Total Capacity, SHC : Sensible Heat Capacity

Capacity Index	Outdoor Air Temp. (°C,DB)	Indoor temperature													
		20(°C,DB)		23(°C,DB)		26(°C,DB)		27(°C,DB)		28(°C,DB)		30(°C,DB)		32(°C,DB)	
		14(°C,WB)		16(°C,WB)		18(°C,WB)		19(°C,WB)		20(°C,WB)		22(°C,WB)		24(°C,WB)	
		TC	SHC	TC	SHC	TC	SHC	TC	SHC	TC	SHC	TC	SHC	TC	SHC
036	10	2.5	2.1	2.9	2.2	3.4	2.3	3.6	2.4	3.7	2.4	4.0	2.4	4.3	2.3
	12	2.5	2.1	2.9	2.2	3.4	2.3	3.6	2.4	3.7	2.4	4.0	2.4	4.3	2.3
	14	2.5	2.1	2.9	2.2	3.4	2.3	3.6	2.4	3.7	2.4	4.0	2.4	4.3	2.3
	16	2.5	2.1	2.9	2.2	3.4	2.3	3.6	2.4	3.7	2.4	4.0	2.4	4.3	2.3
	18	2.5	2.1	2.9	2.2	3.4	2.3	3.6	2.4	3.7	2.4	4.0	2.4	4.3	2.3
	20	2.5	2.1	2.9	2.2	3.4	2.3	3.6	2.4	3.7	2.4	4.0	2.4	4.2	2.3
	21	2.5	2.1	2.9	2.2	3.4	2.3	3.6	2.4	3.7	2.4	4.0	2.4	4.2	2.3
	23	2.5	2.1	2.9	2.2	3.4	2.3	3.6	2.4	3.7	2.4	4.0	2.4	4.2	2.3
	25	2.5	2.1	2.9	2.2	3.4	2.3	3.6	2.4	3.7	2.4	4.0	2.4	4.2	2.3
	27	2.5	2.1	2.9	2.2	3.4	2.3	3.6	2.4	3.7	2.4	4.0	2.4	4.2	2.3
	29	2.5	2.1	2.9	2.2	3.4	2.3	3.6	2.4	3.7	2.4	4.0	2.4	4.2	2.3
	31	2.5	2.1	2.9	2.2	3.4	2.3	3.6	2.4	3.7	2.4	4.0	2.4	4.2	2.3
	33	2.5	2.1	2.9	2.2	3.4	2.3	3.6	2.4	3.7	2.4	4.0	2.4	4.2	2.3
	35	2.5	2.1	2.9	2.2	3.4	2.3	3.6	2.4	3.7	2.4	4.0	2.4	4.2	2.3
	37	2.5	2.1	2.9	2.2	3.4	2.3	3.6	2.4	3.7	2.4	3.9	2.3	4.2	2.3
	39	2.5	2.1	2.9	2.2	3.4	2.3	3.6	2.4	3.7	2.4	3.9	2.3	4.1	2.2
42	2.5	2.1	2.9	2.2	3.4	2.3	3.6	2.4	3.7	2.4	3.8	2.3	4.0	2.1	
44	2.5	2.1	2.9	2.2	3.3	2.2	3.4	2.3	3.6	2.3	3.7	2.2	3.9	2.1	
46	2.5	2.1	2.9	2.2	3.2	2.2	3.3	2.2	3.4	2.2	3.6	2.1	3.8	2.0	
48	2.5	2.1	2.8	2.2	3.2	2.1	3.2	2.2	3.4	2.2	3.5	2.0	3.6	1.9	
045	10	3.1	2.4	3.7	2.7	4.3	2.9	4.5	3.0	4.7	3.0	5.1	3.1	5.4	2.8
	12	3.1	2.4	3.7	2.7	4.3	2.9	4.5	3.0	4.7	3.0	5.1	3.1	5.4	2.8
	14	3.1	2.4	3.7	2.7	4.3	2.9	4.5	3.0	4.7	3.0	5.0	3.0	5.4	2.8
	16	3.1	2.4	3.7	2.7	4.3	2.9	4.5	3.0	4.7	3.0	5.0	3.0	5.3	2.8
	18	3.1	2.4	3.7	2.7	4.3	2.9	4.5	3.0	4.7	3.0	5.0	3.0	5.3	2.8
	20	3.1	2.4	3.7	2.7	4.3	2.9	4.5	3.0	4.7	3.0	5.0	3.0	5.3	2.8
	21	3.1	2.4	3.7	2.7	4.3	2.9	4.5	3.0	4.7	3.0	5.0	3.0	5.3	2.8
	23	3.1	2.4	3.7	2.7	4.3	2.9	4.5	3.0	4.7	3.0	5.0	3.0	5.3	2.8
	25	3.1	2.4	3.7	2.7	4.3	2.9	4.5	3.0	4.7	3.0	5.0	3.0	5.3	2.8
	27	3.1	2.4	3.7	2.7	4.3	2.9	4.5	3.0	4.7	3.0	5.0	3.0	5.3	2.8
	29	3.1	2.4	3.7	2.7	4.3	2.9	4.5	3.0	4.7	3.0	5.0	3.0	5.3	2.8
	31	3.1	2.4	3.7	2.7	4.3	2.9	4.5	3.0	4.7	3.0	5.0	3.0	5.3	2.8
	33	3.1	2.4	3.7	2.7	4.3	2.9	4.5	3.0	4.7	3.0	5.0	3.0	5.3	2.8
	35	3.1	2.4	3.7	2.7	4.3	2.9	4.5	3.0	4.7	3.0	5.0	3.0	5.3	2.8
	37	3.1	2.4	3.7	2.7	4.3	2.9	4.5	3.0	4.7	3.0	4.9	2.9	5.2	2.7
	39	3.1	2.4	3.7	2.7	4.3	2.9	4.5	3.0	4.7	3.0	4.9	2.9	5.1	2.6
42	3.1	2.4	3.7	2.7	4.2	2.9	4.4	3.0	4.6	3.0	4.8	2.9	5.0	2.5	
44	3.1	2.4	3.7	2.7	4.1	2.8	4.3	2.9	4.5	2.9	4.6	2.8	4.8	2.5	
46	3.1	2.4	3.7	2.7	4.0	2.8	4.2	2.8	4.3	2.8	4.5	2.7	4.7	2.4	
48	3.1	2.3	3.6	2.6	4.0	2.7	4.0	2.7	4.3	2.7	4.3	2.6	4.5	2.3	
056	10	3.9	3.0	4.6	3.4	5.3	3.7	5.6	3.8	5.8	3.8	6.3	3.9	6.7	3.6
	12	3.9	3.0	4.6	3.4	5.3	3.7	5.6	3.8	5.8	3.8	6.3	3.9	6.7	3.6
	14	3.9	3.0	4.6	3.4	5.3	3.7	5.6	3.8	5.8	3.8	6.2	3.8	6.7	3.6
	16	3.9	3.0	4.6	3.4	5.3	3.7	5.6	3.8	5.8	3.8	6.2	3.8	6.6	3.5
	18	3.9	3.0	4.6	3.4	5.3	3.7	5.6	3.8	5.8	3.8	6.2	3.8	6.6	3.5
	20	3.9	3.0	4.6	3.4	5.3	3.7	5.6	3.8	5.8	3.8	6.2	3.8	6.6	3.5
	21	3.9	3.0	4.6	3.4	5.3	3.7	5.6	3.8	5.8	3.8	6.2	3.8	6.6	3.5
	23	3.9	3.0	4.6	3.4	5.3	3.7	5.6	3.8	5.8	3.8	6.2	3.8	6.6	3.5
	25	3.9	3.0	4.6	3.4	5.3	3.7	5.6	3.8	5.8	3.8	6.2	3.8	6.6	3.5
	27	3.9	3.0	4.6	3.4	5.3	3.7	5.6	3.8	5.8	3.8	6.2	3.8	6.6	3.5
	29	3.9	3.0	4.6	3.4	5.3	3.7	5.6	3.8	5.8	3.8	6.2	3.8	6.6	3.5
	31	3.9	3.0	4.6	3.4	5.3	3.7	5.6	3.8	5.8	3.8	6.2	3.8	6.6	3.5
	33	3.9	3.0	4.6	3.4	5.3	3.7	5.6	3.8	5.8	3.8	6.2	3.8	6.6	3.5
	35	3.9	3.0	4.6	3.4	5.3	3.7	5.6	3.8	5.8	3.8	6.2	3.8	6.6	3.5
	37	3.9	3.0	4.6	3.4	5.3	3.7	5.6	3.8	5.8	3.8	6.1	3.7	6.5	3.4
	39	3.9	3.0	4.6	3.4	5.3	3.7	5.6	3.8	5.8	3.8	6.1	3.7	6.4	3.3
42	3.9	3.0	4.6	3.4	5.3	3.7	5.5	3.7	5.7	3.8	6.0	3.6	6.2	3.2	
44	3.9	3.0	4.6	3.4	5.1	3.6	5.3	3.6	5.6	3.6	5.8	3.5	6.0	3.1	
46	3.9	3.0	4.6	3.4	5.0	3.5	5.2	3.5	5.4	3.5	5.6	3.4	5.9	3.0	
48	3.9	3.0	4.5	3.3	5.0	3.5	5.0	3.4	5.3	3.5	5.4	3.3	5.7	2.9	

2 Capacity table

Neo Forte

Cooling

TC : Total Capacity, SHC : Sensible Heat Capacity

Capacity Index	Outdoor Air Temp. (°C, DB)	Indoor temperature													
		20(°C, DB)		23(°C, DB)		26(°C, DB)		27(°C, DB)		28(°C, DB)		30(°C, DB)		32(°C, DB)	
		14(°C, WB)		16(°C, WB)		18(°C, WB)		19(°C, WB)		20(°C, WB)		22(°C, WB)		24(°C, WB)	
		TC	SHC	TC	SHC	TC	SHC	TC	SHC	TC	SHC	TC	SHC	TC	SHC
071	10	4.9	3.9	5.7	4.3	6.7	4.7	7.1	4.8	7.4	4.8	7.9	4.8	8.6	4.6
	12	4.9	3.9	5.7	4.3	6.7	4.7	7.1	4.8	7.4	4.8	7.9	4.8	8.5	4.5
	14	4.9	3.9	5.7	4.3	6.7	4.7	7.1	4.8	7.4	4.8	7.9	4.8	8.5	4.5
	16	4.9	3.9	5.7	4.3	6.7	4.7	7.1	4.8	7.4	4.8	7.9	4.8	8.5	4.5
	18	4.9	3.9	5.7	4.3	6.7	4.7	7.1	4.8	7.3	4.8	7.8	4.7	8.4	4.4
	20	4.9	3.9	5.7	4.3	6.7	4.7	7.1	4.8	7.3	4.8	7.8	4.7	8.4	4.4
	21	4.9	3.9	5.7	4.3	6.7	4.7	7.1	4.8	7.3	4.8	7.8	4.7	8.4	4.4
	23	4.9	3.9	5.7	4.3	6.7	4.7	7.1	4.8	7.3	4.8	7.8	4.7	8.4	4.4
	25	4.9	3.9	5.7	4.3	6.7	4.7	7.1	4.8	7.3	4.8	7.8	4.7	8.4	4.4
	27	4.9	3.9	5.7	4.3	6.7	4.7	7.1	4.8	7.3	4.8	7.8	4.7	8.4	4.4
	29	4.9	3.9	5.7	4.3	6.7	4.7	7.1	4.8	7.3	4.8	7.8	4.7	8.4	4.4
	31	4.9	3.9	5.7	4.3	6.7	4.7	7.1	4.8	7.3	4.8	7.8	4.7	8.4	4.4
	33	4.9	3.9	5.7	4.3	6.7	4.7	7.1	4.8	7.3	4.8	7.8	4.7	8.4	4.4
	35	4.9	3.9	5.7	4.3	6.7	4.7	7.1	4.8	7.3	4.8	7.8	4.7	8.4	4.4
	37	4.9	3.9	5.7	4.3	6.7	4.7	7.1	4.8	7.3	4.8	7.8	4.7	8.2	4.3
	39	4.9	3.9	5.7	4.3	6.7	4.7	7.1	4.8	7.3	4.8	7.7	4.6	8.0	4.2
	42	4.9	3.9	5.7	4.3	6.6	4.7	7.0	4.7	7.2	4.7	7.6	4.5	7.8	4.1
44	4.9	3.9	5.7	4.3	6.5	4.5	6.8	4.6	7.0	4.6	7.3	4.3	7.6	3.9	
46	4.9	3.9	5.7	4.2	6.3	4.5	6.6	4.4	6.8	4.5	7.1	4.2	7.4	3.8	
48	4.8	3.8	5.6	4.2	6.2	4.4	6.4	4.3	6.7	4.4	6.9	4.1	7.1	3.7	

2 Capacity table

Neo Forte

Heating

TC : Total Capacity

Capacity Index	Outdoor Air Temp. (°C)		Indoor temperature (°C,DB)				
			16(°C,DB)	18(°C,DB)	20(°C,DB)	22(°C,DB)	24(°C,DB)
	DB	WB	TC kW	TC kW	TC kW	TC kW	TC kW
015	-19.8	-20.0	1.0	1.0	1.0	1.0	1.0
	-18.8	-19.0	1.0	1.0	1.0	1.0	1.0
	-16.7	-17.0	1.1	1.1	1.1	1.1	1.1
	-14.7	-15.0	1.2	1.1	1.1	1.1	1.1
	-12.6	-13.0	1.2	1.2	1.2	1.2	1.2
	-10.5	-11.0	1.4	1.4	1.3	1.3	1.3
	-9.5	-10.0	1.4	1.4	1.3	1.3	1.3
	-8.5	-9.1	1.5	1.5	1.4	1.4	1.4
	-7.0	-7.6	1.6	1.5	1.5	1.4	1.4
	-5.0	-5.6	1.6	1.6	1.6	1.5	1.5
	-3.0	-3.7	1.7	1.7	1.6	1.6	1.5
	0.0	-0.7	1.8	1.7	1.7	1.6	1.5
	3.0	2.2	1.8	1.8	1.7	1.6	1.5
	5.0	4.1	1.9	1.8	1.7	1.6	1.5
	7.0	6.0	1.9	1.8	1.7	1.6	1.5
9.0	7.9	2.0	1.8	1.7	1.6	1.5	
11.0	9.8	2.0	1.8	1.7	1.6	1.5	
13.0	11.8	2.0	1.8	1.7	1.6	1.5	
15.0	13.7	2.0	1.8	1.7	1.6	1.5	
022	-19.8	-20.0	1.5	1.5	1.5	1.5	1.5
	-18.8	-19.0	1.5	1.5	1.5	1.5	1.5
	-16.7	-17.0	1.6	1.6	1.6	1.6	1.6
	-14.7	-15.0	1.7	1.6	1.6	1.6	1.6
	-12.6	-13.0	1.8	1.8	1.8	1.8	1.7
	-10.5	-11.0	2.0	2.0	1.9	1.9	1.9
	-9.5	-10.0	2.1	2.0	2.0	1.9	1.9
	-8.5	-9.1	2.2	2.1	2.1	2.0	2.0
	-7.0	-7.6	2.3	2.2	2.2	2.0	2.0
	-5.0	-5.6	2.4	2.3	2.3	2.2	2.2
	-3.0	-3.7	2.5	2.5	2.4	2.3	2.2
	0.0	-0.7	2.6	2.5	2.5	2.3	2.2
	3.0	2.2	2.7	2.6	2.5	2.3	2.2
	5.0	4.1	2.8	2.7	2.5	2.3	2.2
	7.0	6.0	2.8	2.7	2.5	2.3	2.2
9.0	7.9	3.0	2.7	2.5	2.3	2.2	
11.0	9.8	3.0	2.7	2.5	2.3	2.2	
13.0	11.8	3.0	2.7	2.5	2.3	2.2	
15.0	13.7	3.0	2.7	2.5	2.3	2.2	
028	-19.8	-20.0	1.9	1.9	1.9	1.9	1.9
	-18.8	-19.0	1.9	1.9	1.9	1.9	1.9
	-16.7	-17.0	2.0	2.0	2.0	2.0	1.9
	-14.7	-15.0	2.1	2.1	2.0	2.0	1.9
	-12.6	-13.0	2.2	2.2	2.2	2.1	2.1
	-10.5	-11.0	2.3	2.3	2.3	2.3	2.2
	-9.5	-10.0	2.3	2.3	2.3	2.3	2.2
	-8.5	-9.1	2.4	2.4	2.4	2.4	2.3
	-7.0	-7.6	2.5	2.4	2.4	2.4	2.3
	-5.0	-5.6	2.6	2.6	2.5	2.5	2.4
	-3.0	-3.7	2.8	2.7	2.7	2.6	2.5
	0.0	-0.7	2.9	2.8	2.8	2.7	2.6
	3.0	2.2	3.0	3.0	2.9	2.8	2.7
	5.0	4.1	3.2	3.1	3.1	2.9	2.7
	7.0	6.0	3.3	3.2	3.2	3.0	2.7
9.0	7.9	3.4	3.3	3.2	3.0	2.7	
11.0	9.8	3.5	3.3	3.2	3.0	2.7	
13.0	11.8	3.6	3.4	3.2	3.0	2.7	
15.0	13.7	3.7	3.4	3.2	3.0	2.7	

2 Capacity table

Neo Forte

Heating

TC : Total Capacity

Capacity Index	Outdoor Air Temp. (°C)		Indoor temperature (°C,DB)				
			16(°C,DB)	18(°C,DB)	20(°C,DB)	22(°C,DB)	24(°C,DB)
	DB	WB	TC kW	TC kW	TC kW	TC kW	TC kW
036	-19.8	-20.0	2.4	2.4	2.3	2.3	2.3
	-18.8	-19.0	2.5	2.4	2.3	2.3	2.3
	-16.7	-17.0	2.6	2.5	2.4	2.4	2.3
	-14.7	-15.0	2.7	2.6	2.5	2.5	2.4
	-12.6	-13.0	2.8	2.7	2.7	2.6	2.6
	-10.5	-11.0	2.9	2.9	2.9	2.8	2.8
	-9.5	-10.0	2.9	2.9	2.9	2.8	2.8
	-8.5	-9.1	3.0	3.0	3.0	2.9	2.9
	-7.0	-7.6	3.1	3.1	3.0	3.0	2.9
	-5.0	-5.6	3.3	3.2	3.2	3.1	3.0
	-3.0	-3.7	3.4	3.4	3.3	3.2	3.1
	0.0	-0.7	3.6	3.6	3.5	3.4	3.2
	3.0	2.2	3.8	3.7	3.7	3.5	3.4
	5.0	4.1	3.9	3.9	3.8	3.6	3.4
	7.0	6.0	4.1	4.1	4.0	3.7	3.4
9.0	7.9	4.2	4.1	4.0	3.7	3.4	
11.0	9.8	4.4	4.2	4.0	3.7	3.4	
13.0	11.8	4.5	4.2	4.0	3.7	3.4	
15.0	13.7	4.6	4.3	4.0	3.7	3.4	
045	-19.8	-20.0	3.1	3.0	3.0	2.9	2.9
	-18.8	-19.0	3.1	3.1	3.1	3.0	3.0
	-16.7	-17.0	3.2	3.2	3.1	3.0	3.0
	-14.7	-15.0	3.3	3.3	3.2	3.1	3.0
	-12.6	-13.0	3.5	3.4	3.3	3.3	3.2
	-10.5	-11.0	3.6	3.6	3.5	3.5	3.4
	-9.5	-10.0	3.7	3.7	3.6	3.5	3.5
	-8.5	-9.1	3.8	3.7	3.7	3.6	3.5
	-7.0	-7.6	3.9	3.8	3.8	3.7	3.6
	-5.0	-5.6	4.1	4.1	4.0	3.9	3.7
	-3.0	-3.7	4.3	4.2	4.2	4.1	3.9
	0.0	-0.7	4.5	4.4	4.4	4.2	4.0
	3.0	2.2	4.7	4.7	4.6	4.4	4.2
	5.0	4.1	4.9	4.8	4.8	4.5	4.2
	7.0	6.0	5.2	5.1	5.0	4.6	4.2
9.0	7.9	5.3	5.2	5.0	4.6	4.2	
11.0	9.8	5.5	5.2	5.0	4.6	4.2	
13.0	11.8	5.6	5.3	5.0	4.6	4.2	
15.0	13.7	5.8	5.4	5.0	4.6	4.2	
056	-19.8	-20.0	3.9	3.8	3.8	3.7	3.7
	-18.8	-19.0	3.9	3.9	3.8	3.7	3.7
	-16.7	-17.0	4.0	4.0	3.9	3.8	3.8
	-14.7	-15.0	4.2	4.1	4.0	3.9	3.8
	-12.6	-13.0	4.4	4.3	4.2	4.1	4.0
	-10.5	-11.0	4.6	4.5	4.4	4.4	4.3
	-9.5	-10.0	4.7	4.6	4.6	4.5	4.4
	-8.5	-9.1	4.8	4.7	4.7	4.6	4.5
	-7.0	-7.6	4.9	4.8	4.8	4.7	4.5
	-5.0	-5.6	5.2	5.1	5.0	4.9	4.7
	-3.0	-3.7	5.4	5.3	5.3	5.1	4.9
	0.0	-0.7	5.7	5.6	5.5	5.3	5.0
	3.0	2.2	5.9	5.9	5.8	5.6	5.3
	5.0	4.1	6.2	6.1	6.0	5.7	5.3
	7.0	6.0	6.5	6.4	6.3	5.8	5.3
9.0	7.9	6.7	6.5	6.3	5.8	5.3	
11.0	9.8	6.9	6.6	6.3	5.8	5.3	
13.0	11.8	7.1	6.7	6.3	5.8	5.3	
15.0	13.7	7.3	6.8	6.3	5.8	5.3	

2 Capacity table

Neo Forte

Heating

TC : Total Capacity

Capacity Index	Outdoor Air Temp. (°C)		Indoor temperature (°C, DB)				
			16(°C, DB)	18(°C, DB)	20(°C, DB)	22(°C, DB)	24(°C, DB)
	DB	WB	TC kW	TC kW	TC kW	TC kW	TC kW
071	-19.8	-20.0	5.0	4.9	4.8	4.8	4.8
	-18.8	-19.0	5.1	5.0	4.8	4.8	4.8
	-16.7	-17.0	5.2	5.1	4.9	4.9	4.8
	-14.7	-15.0	5.4	5.3	5.1	4.9	4.8
	-12.6	-13.0	5.6	5.4	5.3	5.2	5.1
	-10.5	-11.0	5.8	5.7	5.6	5.5	5.5
	-9.5	-10.0	5.9	5.9	5.8	5.7	5.6
	-8.5	-9.1	6.0	6.0	5.9	5.8	5.7
	-7.0	-7.6	6.2	6.2	6.1	5.9	5.8
	-5.0	-5.6	6.5	6.4	6.4	6.2	5.9
	-3.0	-3.7	6.9	6.7	6.7	6.4	6.2
	0.0	-0.7	7.2	7.1	7.0	6.7	6.4
	3.0	2.2	7.5	7.4	7.3	7.1	6.7
	5.0	4.1	7.9	7.8	7.7	7.2	6.7
	7.0	6.0	8.2	8.1	8.0	7.4	6.7
	9.0	7.9	8.5	8.2	8.0	7.4	6.7
11.0	9.8	8.7	8.3	8.0	7.4	6.7	
13.0	11.8	9.0	8.5	8.0	7.4	6.7	
15.0	13.7	9.3	8.6	8.0	7.4	6.7	

3 Dimensional drawing

Neo Forte

AM015HNQDEH/EU, AM015HNTDEH/EU, AM022FNQDEH/EU, AM022FNTDEH/EU, AM028FNQDEH/EU, AM028FNTDEH/EU, AM036FNQDEH/EU, AM036FNTDEH/EU

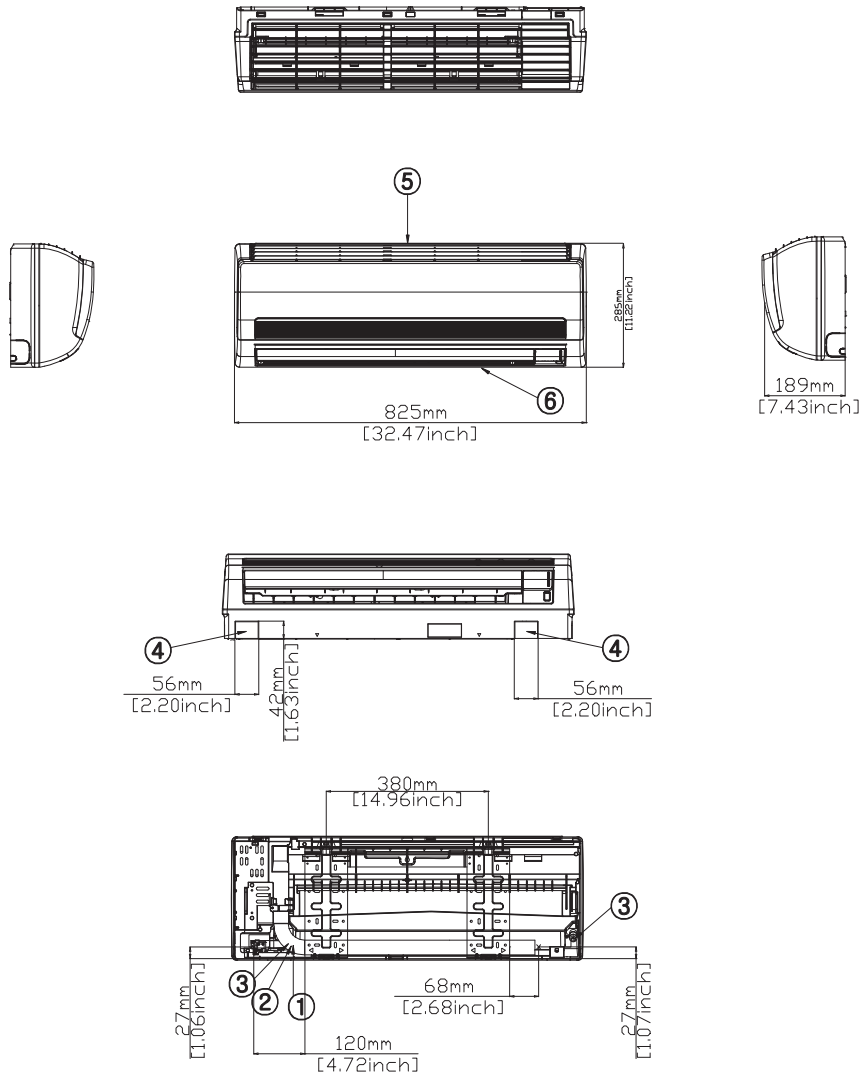

No.	Name
①	Liquid Ref. Pipe
②	Gas Ref. Pipe
③	Drain Pipe Connection
④	Conduit for power supply & Communication wiring
⑤	Air inlet grille
⑥	Air outlet louver

3 Dimensional drawing

Neo Forte

AM045FNQDEH/EU, AM056FNQDEH/EU, AM056FNTDEH/EU, AM071FNQDEH/EU, AM071FNTDEH/EU

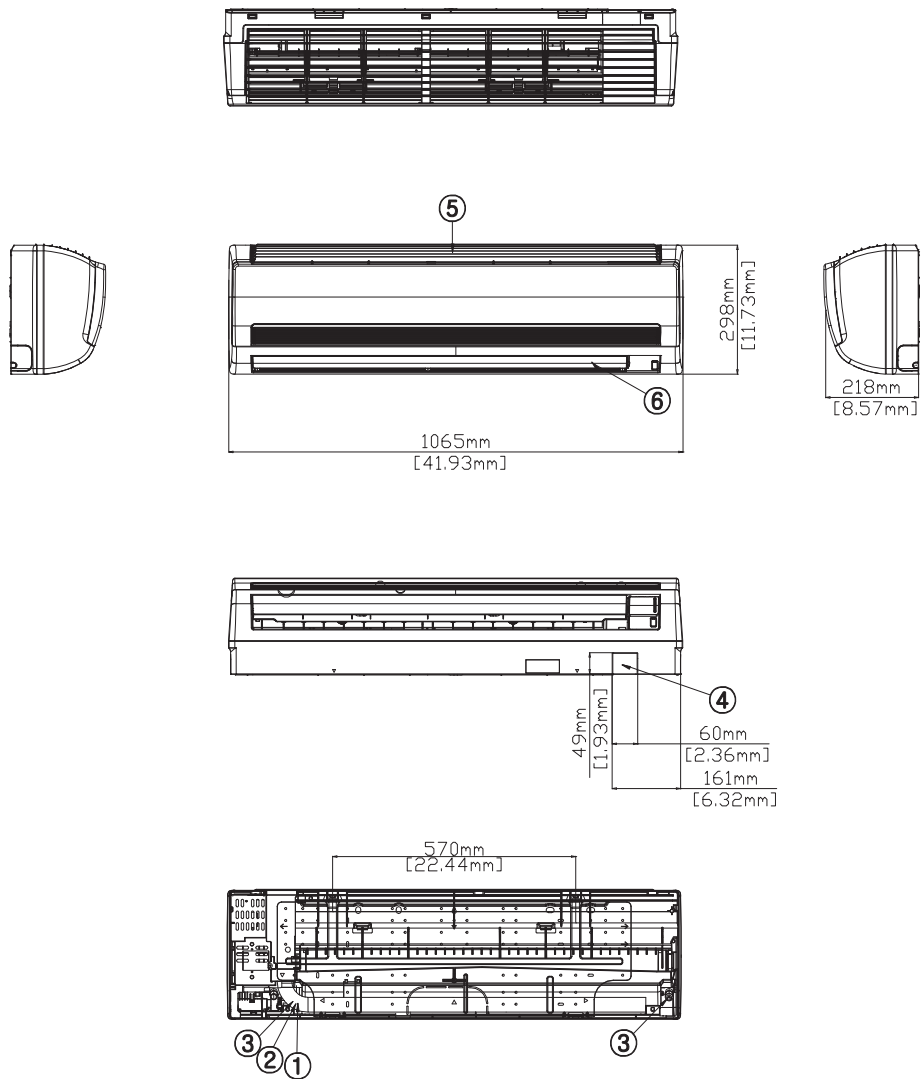

No.	Name
①	Liquid Ref. Pipe
②	Gas Ref. Pipe
③	Drain Pipe Connection
④	Conduit for power supply & Communication wiring
⑤	Air inlet grille
⑥	Air outlet louver

4 Electrical Wiring Diagram

Neo Forte

AM015HNTDEH/EU, AM015HNQDEH/EU, AM022/028/036/056/071FNTDEH/EU, AM022/028/036/045/056/071FNQDEH/EU

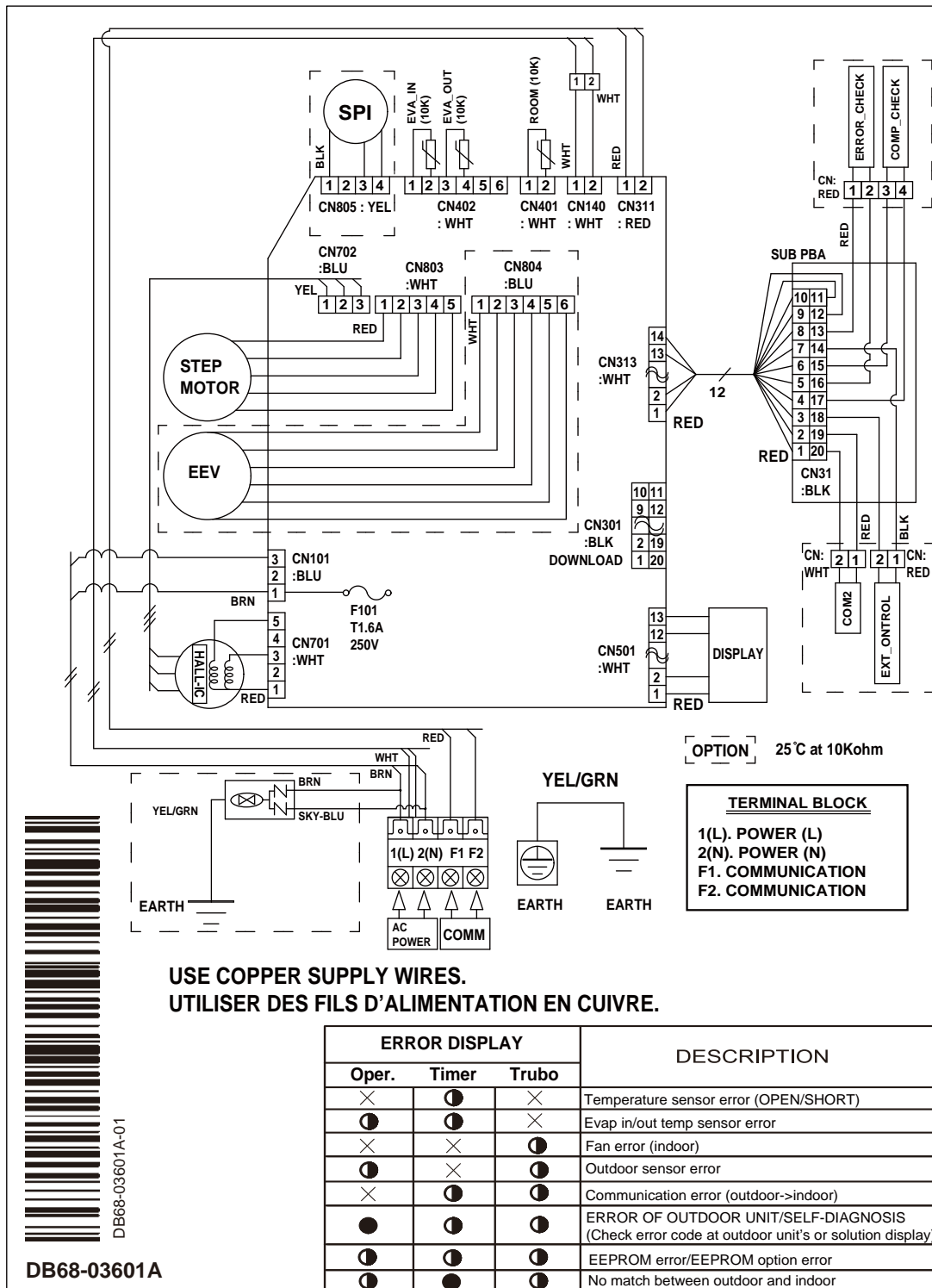

NOTE

1. This wiring diagram applies only to the indoor unit.
2. Symbols show as follow;
 BLK : black, RED : red, BLU : blue, WHT:white, YEL : yellow, BRN : brown, SKY : sky-blue, GRN : green
3. For connection wiring indoor-outdoor transmission F1-F2, indoor-wired remotecontroller transmission F3-F4.
4. : Protective earth(screw), : Connector, n : The wire quantity

5 Sound pressure level

Neo Forte

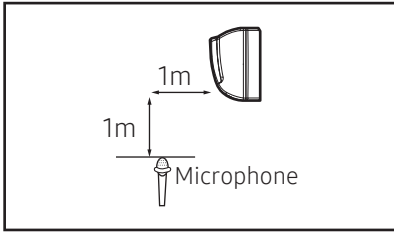

Unit: dB(A)

Model	High	Low
AM015HNQDEH/EU	26	24
AM015HNTDEH/EU	26	24
AM022FNQDEH/EU	31	26
AM022FNTDEH/EU	30	26

Note

Specifications may be subject to change without prior notice.
 Sound pressure level is obtained in an anechoic room.
 Sound pressure level is a relative value, depending on the distance and acoustic environment.
 Sound pressure level may differ depending on operation condition.
 dBA = A-weighted sound pressure level
 Reference acoustic pressure 0 dB= 20 uPa

NR curve

1) AM015HNQDEH/EU

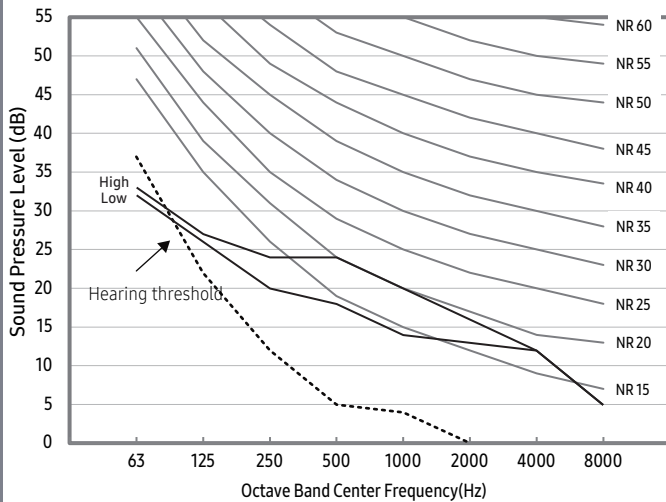

2) AM015HNTDEH/EU

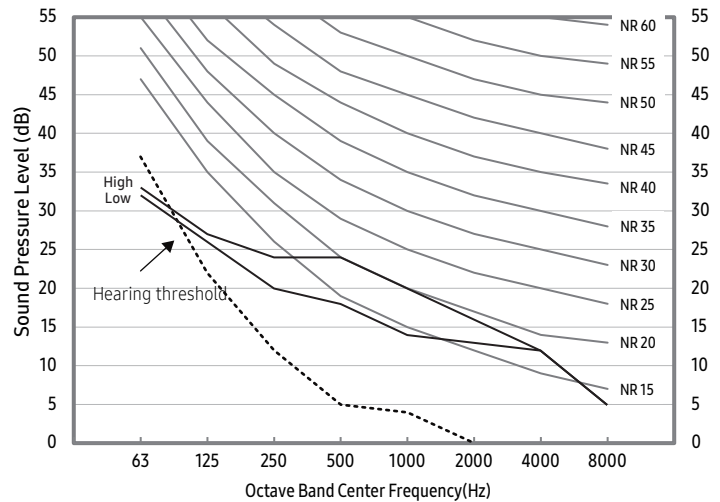

3) AM022FNQDEH/EU

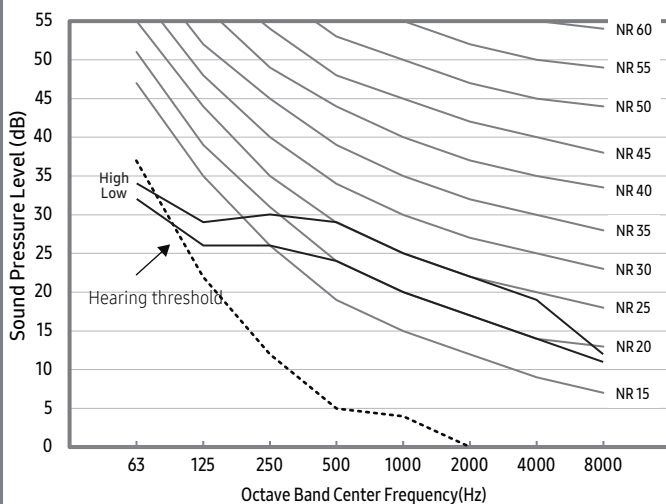

4) AM022FNTDEH/EU

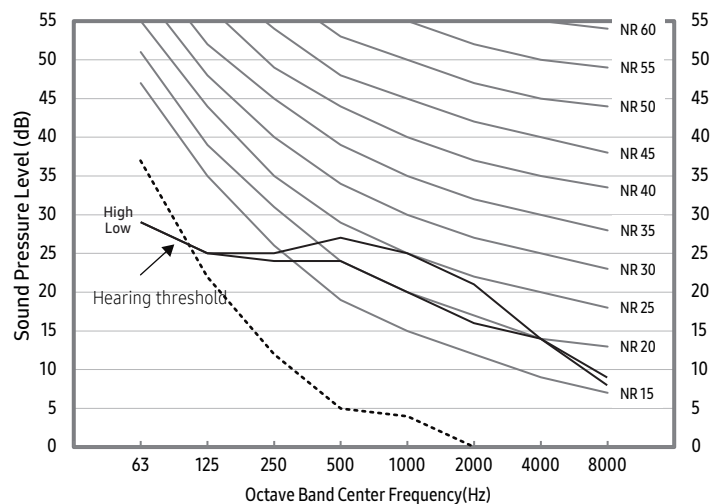

5 Sound pressure level

Neo Forte

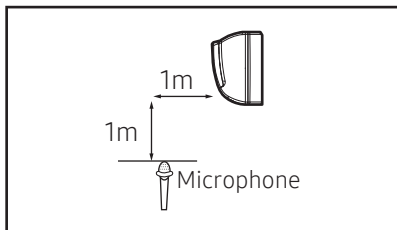

Unit: dB(A)

Model	High	Low
AM028FNQDEH/EU	31	26
AM028FNTDEH/EU	30	26
AM036FNQDEH/EU	37	29
AM036FNTDEH/EU	36	28

Note

Specifications may be subject to change without prior notice.
 Sound pressure level is obtained in an anechoic room.
 Sound pressure level is a relative value, depending on the distance and acoustic environment.
 Sound pressure level may differ depending on operation condition.
 dBA = A-weighted sound pressure level
 Reference acoustic pressure 0 dB= 20 uPa

NR curve

1) AM028FNQDEH/EU

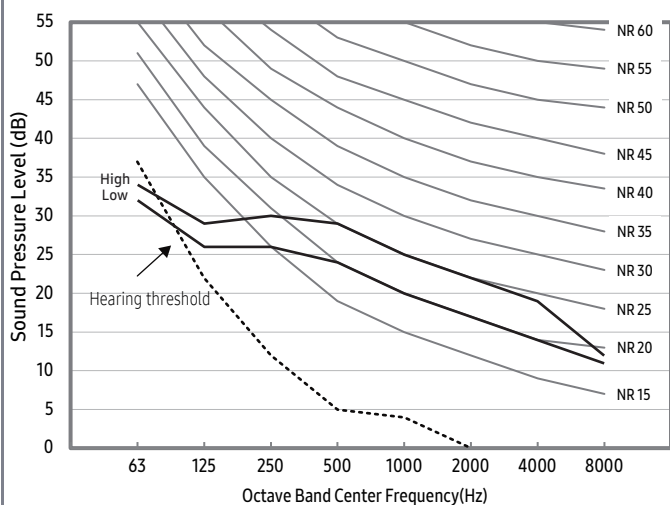

2) AM028FNTDEH/EU

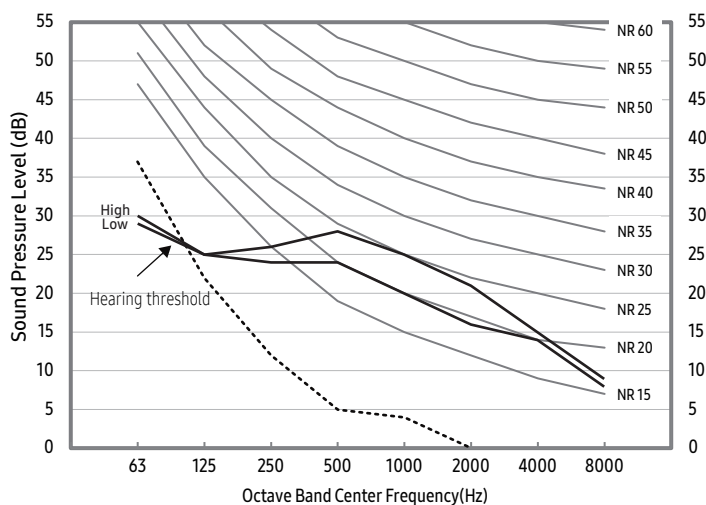

3) AM036FNQDEH/EU

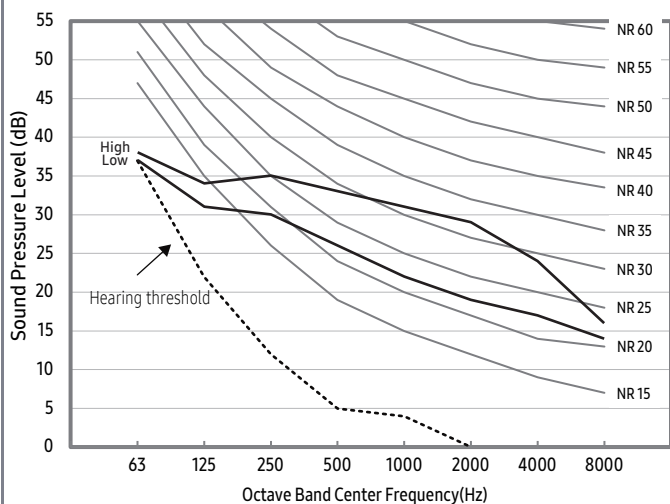

4) AM036FNTDEH/EU

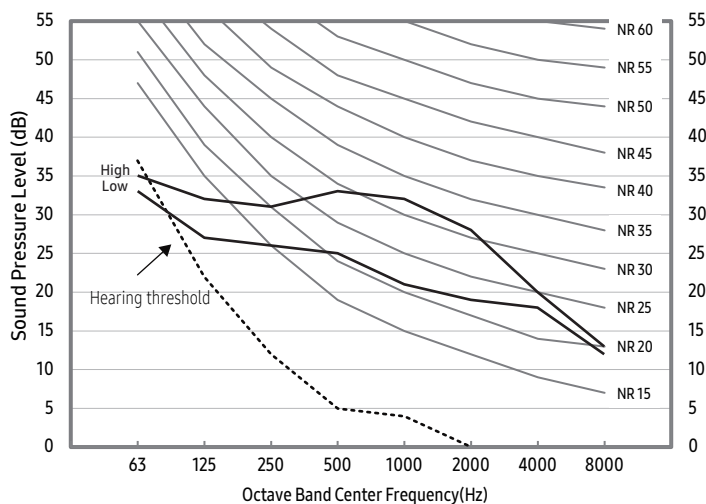

5 Sound pressure level

Neo Forte

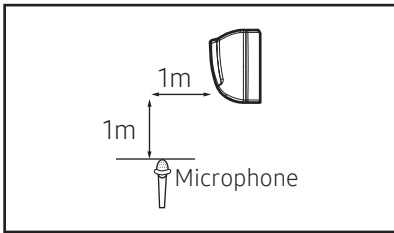

Unit: dB(A)

Model	High	Low
AM045FNQDEH/EU	39	34
AM056FNQDEH/EU	42	35
AM056FNTDEH/EU	42	35
AM071FNQDEH/EU	45	35

Note

Specifications may be subject to change without prior notice.
 Sound pressure level is obtained in an anechoic room.
 Sound pressure level is a relative value, depending on the distance and acoustic environment.
 Sound pressure level may differ depending on operation condition.
 dBA = A-weighted sound pressure level
 Reference acoustic pressure 0 dB= 20 uPa

NR curve

1) AM045FNQDEH/EU

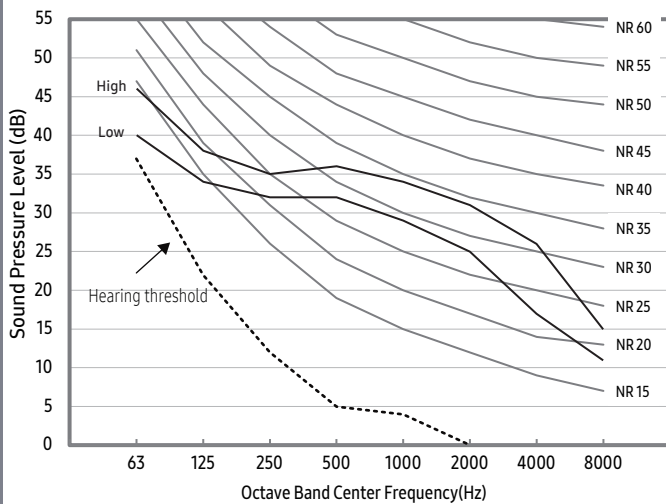

2) AM056FNQDEH/EU

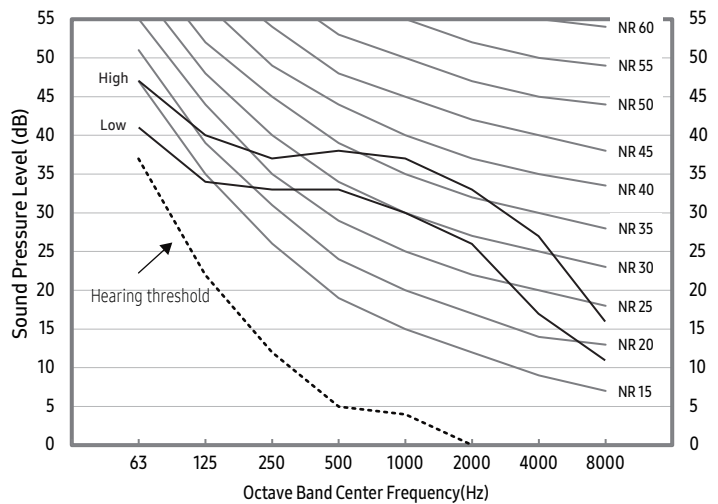

3) AM056FNTDEH/EU

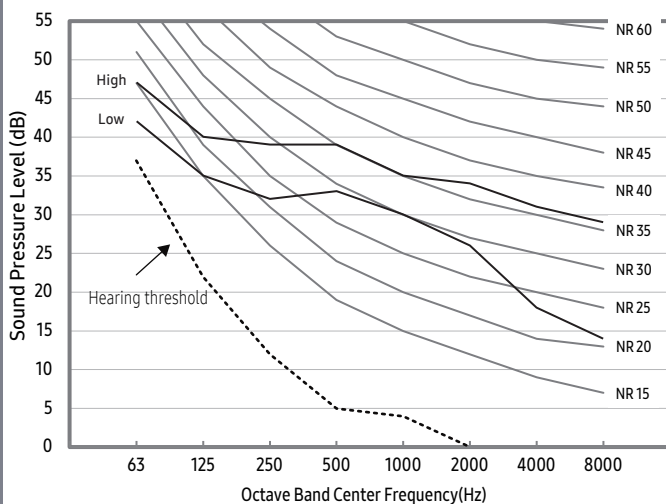

4) AM071FNQDEH/EU

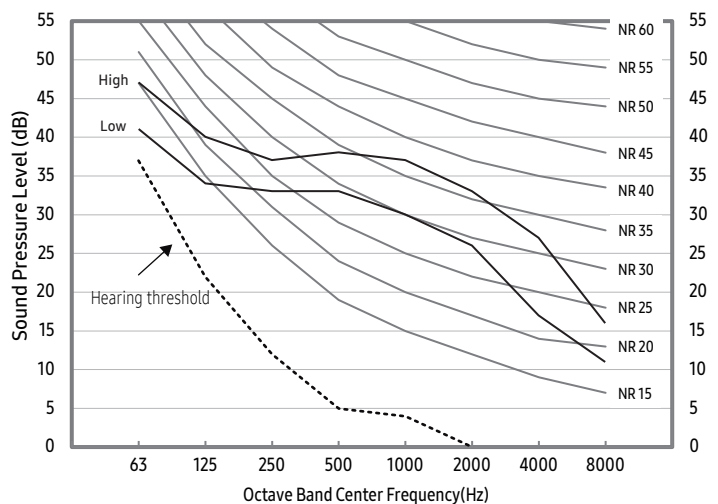

5 Sound pressure level

Neo Forte

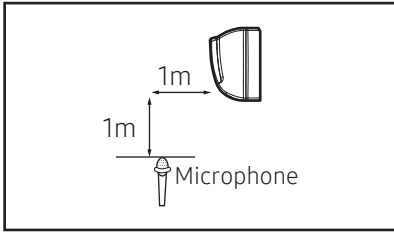

Unit: dB(A)

Model	High	Low
AM071FNTDEH/EU	44	35

Note

Specifications may be subject to change without prior notice.
 Sound pressure level is obtained in an anechoic room.
 Sound pressure level is a relative value, depending on the distance and acoustic environment.
 Sound pressure level may differ depending on operation condition.
 dBA = A-weighted sound pressure level
 Reference acoustic pressure 0 dB= 20 uPa

NR curve

1) AM071FNTDEH/EU

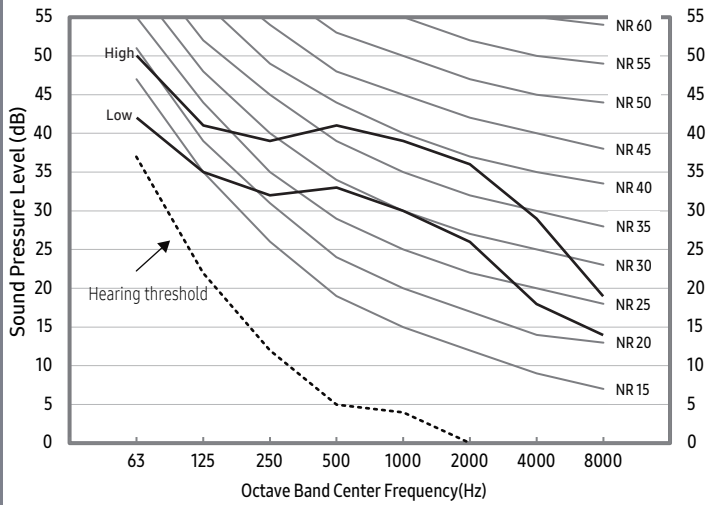

6 Sound power level

Neo Forte

Note

- . Specifications may be subject to change without prior notice.
- . Sound power level is an absolute value that a sound source generates.
- . dBA = A-weighted sound power level.
- . Reference power : 1pW.
- . Measured according to ISO 3741

Unit: dB(A)

Model	Power
AM015HNQDEH/EU	43
AM015HNTDEH/EU	43
AM022FNQDEH/EU	49
AM022FNTDEH/EU	48

1)AM015HNQDEH/EU

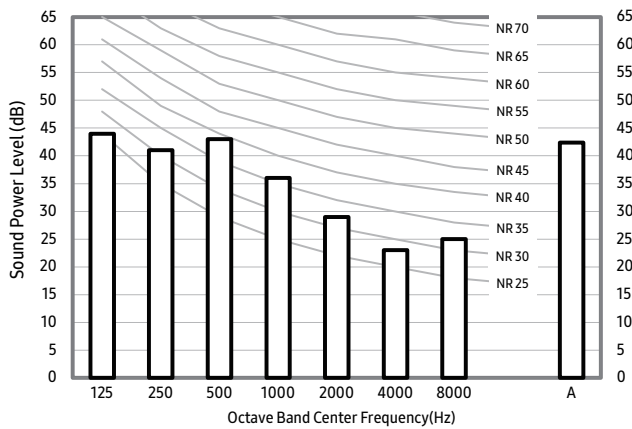

2)AM015HNTDEH/EU

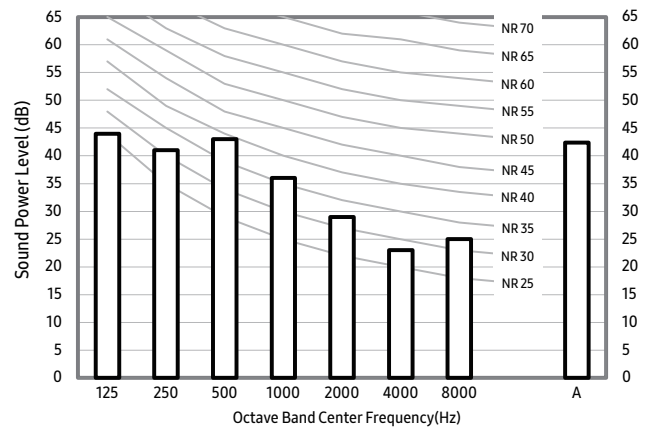

3)AM022FNQDEH/EU

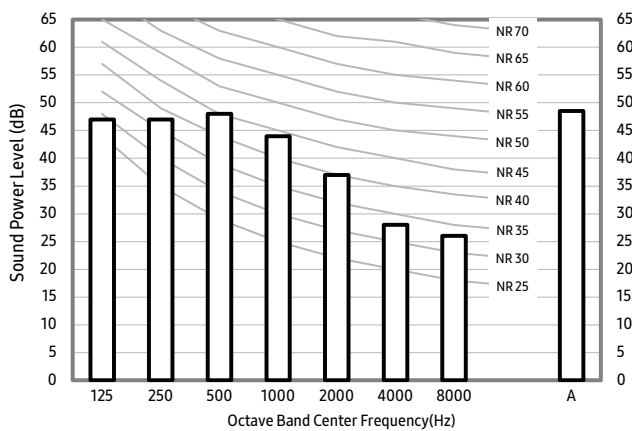

4)AM022FNTDEH/EU

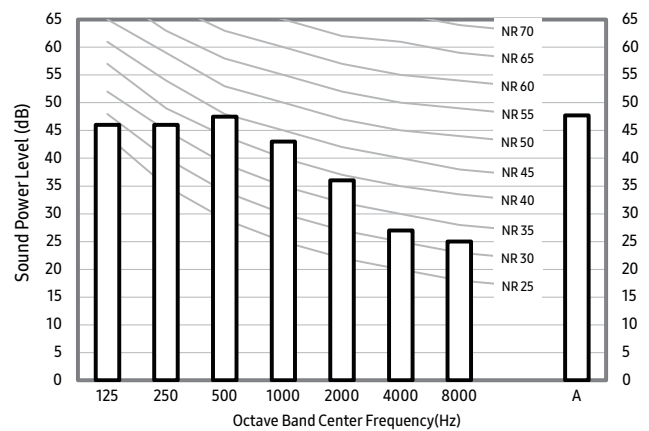

6 Sound power level

Neo Forte

Note

- . Specifications may be subject to change without prior notice.
- . Sound power level is an absolute value that a sound source generates.
- . dBA = A-weighted sound power level.
- . Reference power : 1pW.
- . Measured according to ISO 3741

Unit: dB(A)

Model	Power
AM028FNQDEH/EU	49
AM028FNTDEH/EU	48
AM036FNQDEH/EU	54
AM036FNTDEH/EU	53

1)AM028FNQDEH/EU

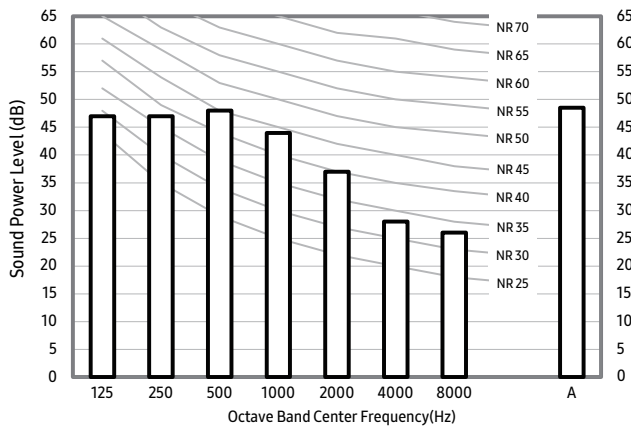

2)AM028FNTDEH/EU

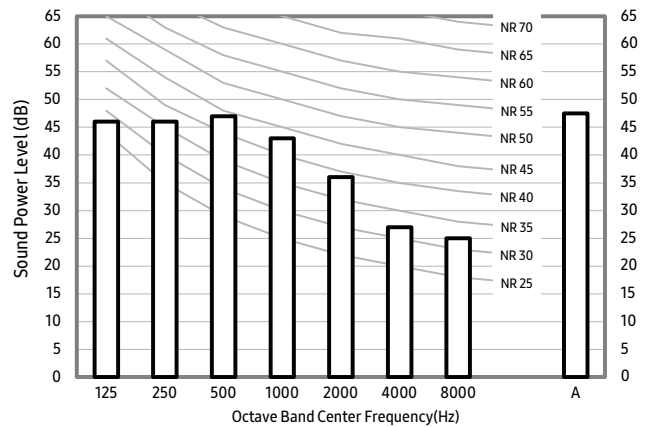

3)AM036FNQDEH/EU

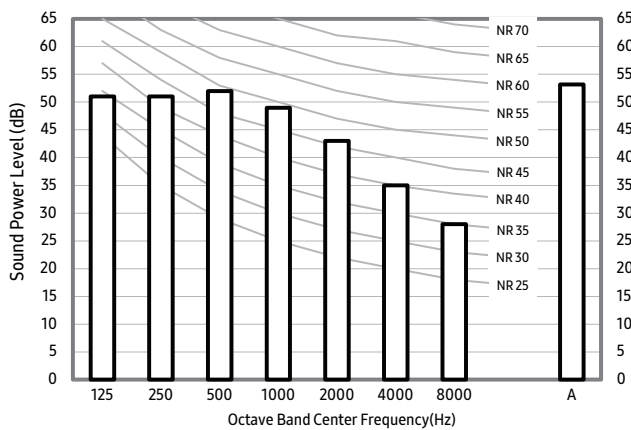

4)AM036FNTDEH/EU

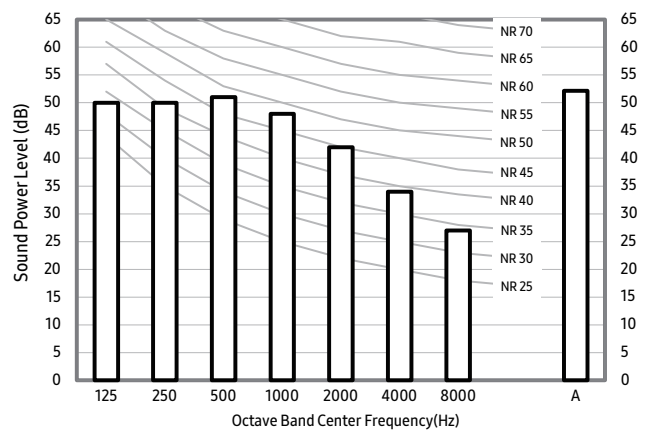

6 Sound power level

Neo Forte

Note

- . Specifications may be subject to change without prior notice.
- . Sound power level is an absolute value that a sound source generates.
- . dBA = A-weighted sound power level.
- . Reference power : 1pW.
- . Measured according to ISO 3741

Unit: dB(A)

Model	Power
AM045FNQDEH/EU	55
AM056FNQDEH/EU	58
AM056FNTDEH/EU	57
AM071FNQDEH/EU	60

1)AM045FNQDEH/EU

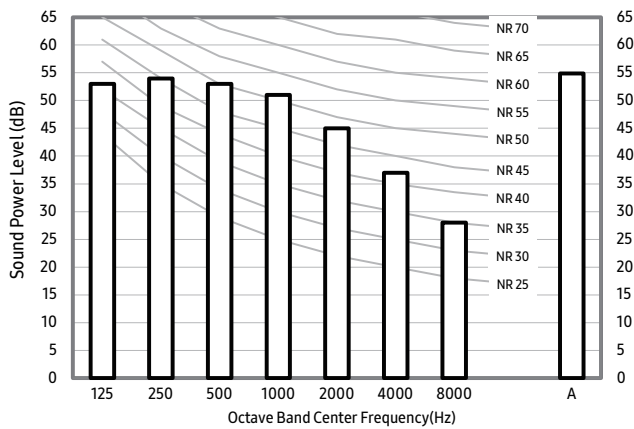

2)AM056FNQDEH/EU

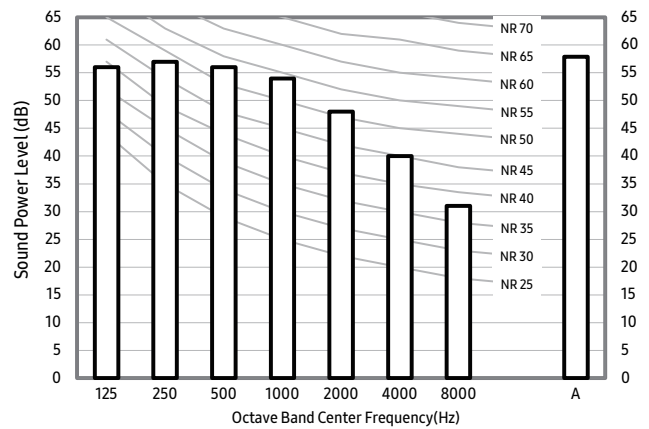

3)AM056FNTDEH/EU

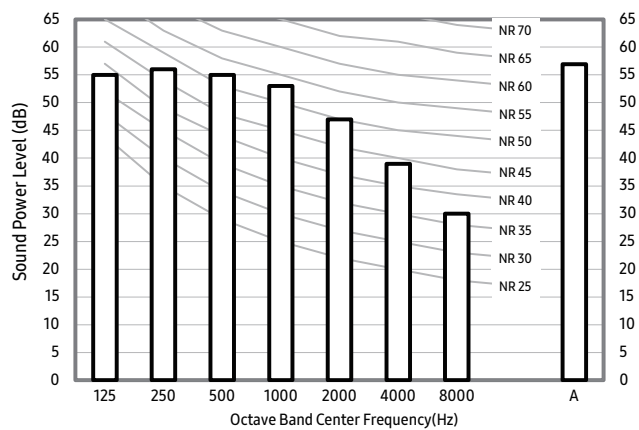

4)AM071FNQDEH/EU

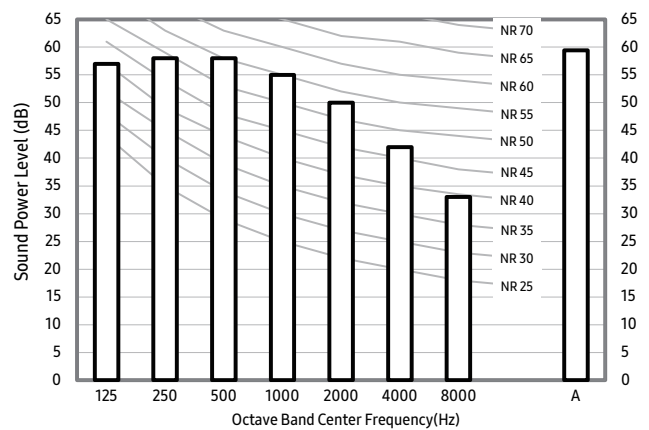

6 Sound power level

Neo Forte

Note

- . Specifications may be subject to change without prior notice.
- . Sound power level is an absolute value that a sound source generates.
- . dBA = A-weighted sound power level.
- . Reference power : 1pW.
- . Measured according to ISO 3741

Unit: dB(A)

Model	Power
AM071FNTDEH/EU	59

1)AM071FNTDEH/EU

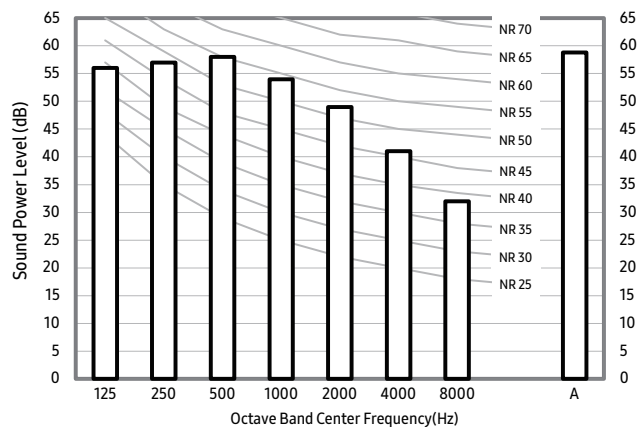

7 Temperature and air flow distribution

Neo Forte

AM036FNTDEH/EU, AM036FNQDEH/EU

(1) Cooling air velocity distribution

Discharge angle : 60°

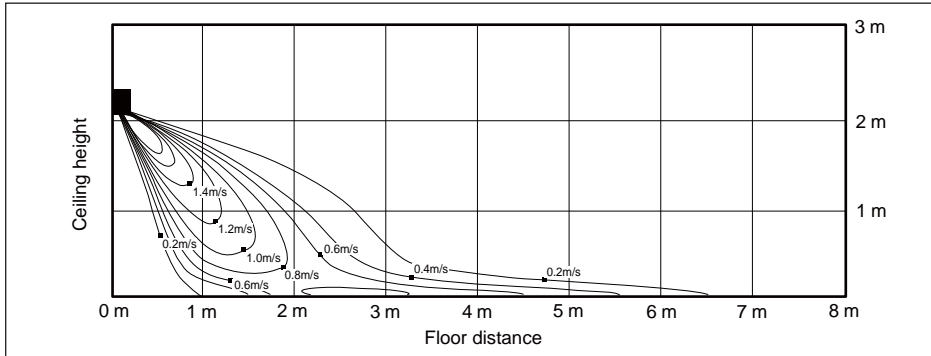

(2) Cooling temperature distribution

Discharge angle : 60°

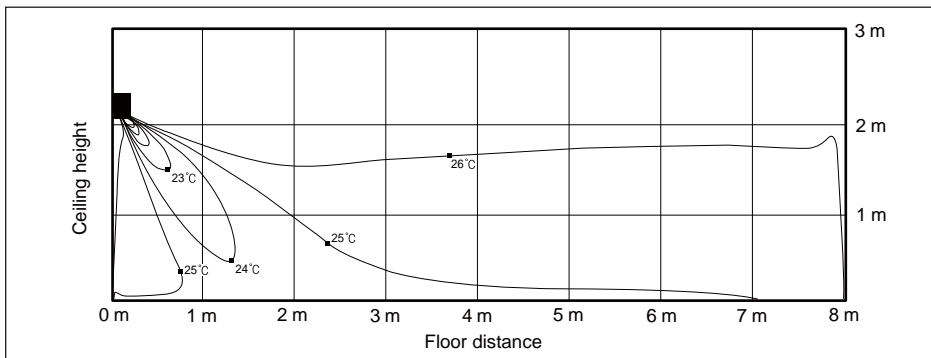

(3) Heating air velocity distribution

Discharge angle : 60°

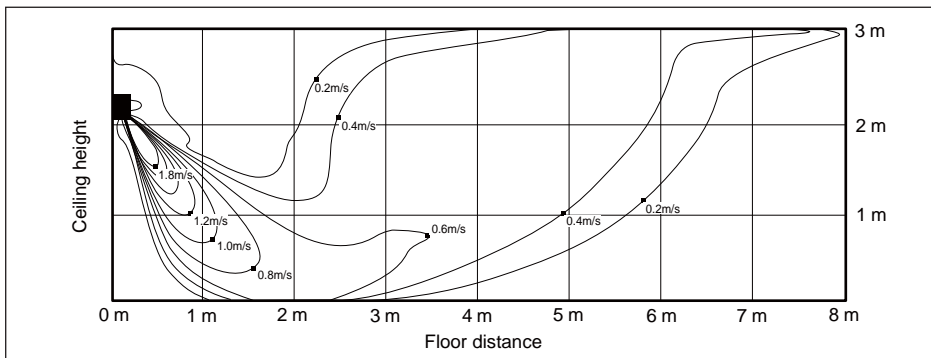

(4) Heating temperature distribution

Discharge angle : 60°

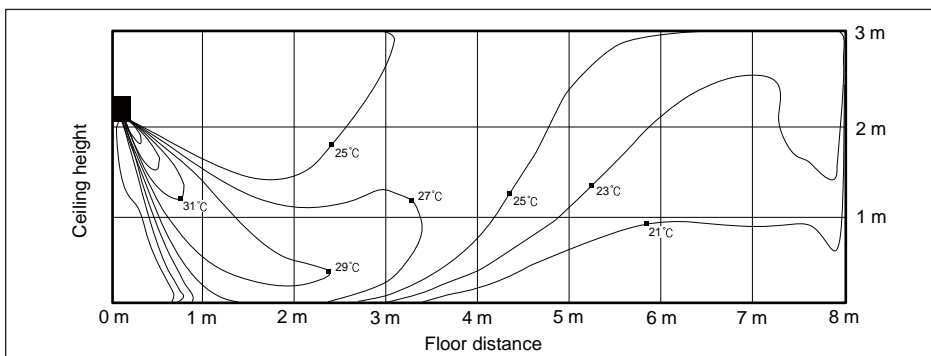

7 Temperature and air flow distribution

Neo Forte

AM071FNTDEH/EU, AM071FNQDEH/EU

(1) Cooling air velocity distribution

Discharge angle : 60°

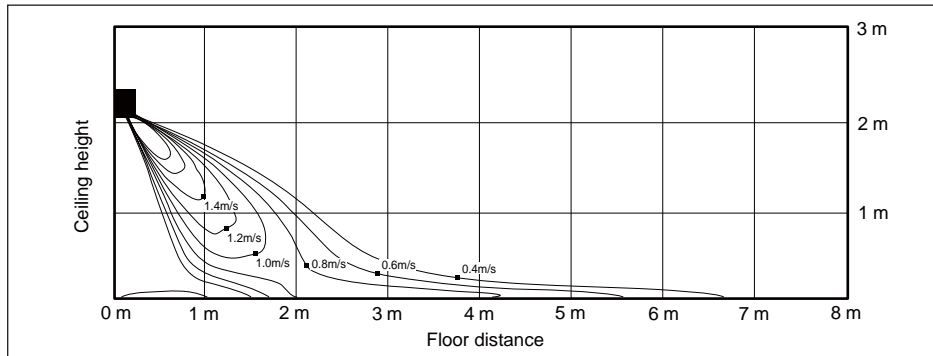

(2) Cooling temperature distribution

Discharge angle : 60°

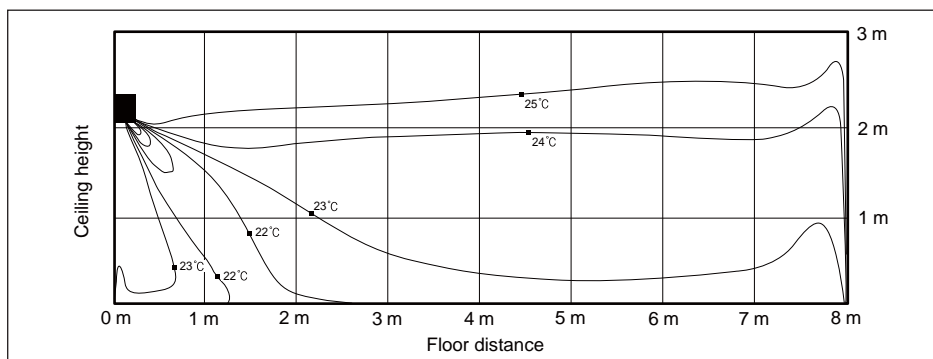

(3) Heating air velocity distribution

Discharge angle : 60°

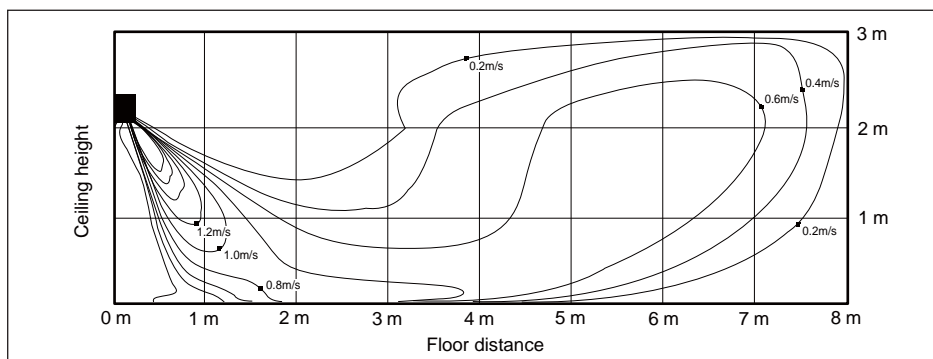

(4) Heating temperature distribution

Discharge angle : 60°

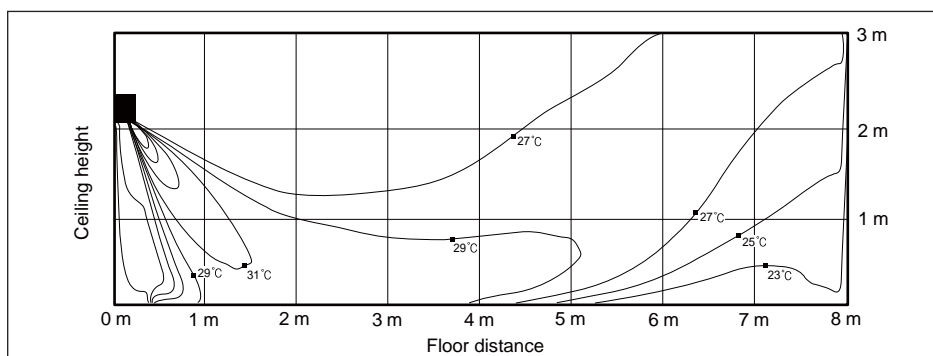

AR5000

- 1 *Specifications*
- 2 *Capacity Table*
- 3 *Dimensional Drawing*
- 4 *Electrical Wiring Diagram*
- 5 *Sound Pressure Level*
- 6 *Sound Power Level*
- 7 *Temperature and air flow distribution*

1 Specifications

AR5000

Type			AR5000	AR5000	AR5000	
Model			AM015JNVDKH/EU	AM022JNVDKH/EU	AM028JNVDKH/EU	
Power Supply		Ø, #, V, Hz	1,2,220-240,50/60	1,2,220-240,50/60	1,2,220-240,50/60	
Mode			-	HP/HR	HP/HR	
Performance	Capacity (Nominal)	Cooling	kW	1.50	2.20	2.80
			Btu/h	5,100	7,500	9,600
		Heating	kW	1.70	2.50	3.20
			Btu/h	5,800	8,500	10,900
Power	Power Input (Nominal)	Cooling	W	14.00	15.00	16.00
		Heating	W	16.00	18.00	24.00
	Current Input (Nominal)	Cooling	A	0.12	0.13	0.13
		Heating	A	0.13	0.15	0.19
Fan	Motor	Type	-	Crossflow Fan	Crossflow Fan	Crossflow Fan
		Output x n	w	27 x 1	27 x 1	27 x 1
	Air Flow Rate	H/M/L (UL)	CMM	4.40 / 4.20 / 3.80	5.40 / 4.70 / 4.00	5.70 / 5.00 / 4.30
			l/s	73.33 / 70.00 / 63.33	90.00 / 78.33 / 66.67	95.00 / 83.33 / 71.67
	External Pressure	Min/Std/Max	mmAq	-	-	-
Pa			-	-	-	
Piping Connections	Liquid Pipe	Ø, mm	6.35	6.35	6.35	
		Ø, inch	1/4"	1/4"	1/4"	
	Gas Pipe	Ø, mm	12.70	12.70	12.70	
		Ø, inch	1/2"	1/2"	1/2"	
Drain Pipe	Ø, mm	ID18 HOSE	ID18 HOSE	ID18 HOSE		
Field Wiring	Power Source Wire	mm ²	1.5 - 2.5	1.5 - 2.5	1.5 - 2.5	
	Transmission Cable	mm ²	0.75 - 1.50	0.75 - 1.50	0.75 - 1.50	
Refrigerant	Type	-	R410A	R410A	R410A	
	Control Method	-	EEV INCLUDED	EEV INCLUDED	EEV INCLUDED	
Sound	Pressure	High / Mid / Low	dB(A)	28 / 25 / 24	33 / 29 / 25	36 / 31 / 25
	Power	Cooling		44	50	53
Dimension	Net Weight		kg	7.9	7.9	8.0
	Shipping Weight		kg	9.3	9.3	9.4
	Net Dimensions (WxHxD)		mm	750 x 249 x 246	750 x 249 x 246	750 x 249 x 246
	Shipping Dimensions (WxHxD)		mm	800 x 298 x 302	800 x 298 x 302	800 x 298 x 302
Panel Size	Panel model		-	-	-	-
	Panel Net Weight		kg	-	-	-
	Shipping Weight		kg	-	-	-
	Net Dimensions (WxHxD)		mm	-	-	-
	Shipping Dimensions (WxHxD)		mm	-	-	-
Accessories	Drain Pump	Drain Pump	- / Model	-	-	-
		Max. lifting Height / Displacement	mm/liter/h	-	-	-
	Virus Doctor		-	INCLUDED	INCLUDED	INCLUDED

* Specifications may be subject to change without prior notice for product improvement.

*1) Mode

- HP : Heat Pump, HR : Heat Recovery

*2) Nominal cooling capacities are based on;

- Indoor temperature : 27°C DB, 19°C WB

- Outdoor temperature : 35°C DB, 24°C WB, Equivalent refrigerant piping : 7.5m, Level differences : 0m

*3) Nominal heating capacities are based on;

- Indoor temperature : 20°C DB, 15°C WB

- Outdoor temperature : 7°C DB, 6°C WB, Equivalent refrigerant piping : 7.5m, Level differences : 0m

*4) Sound pressure was acquired in an anechoic room. Thus actual noise level may be different depending on the installation conditions.

*5) These products contain R410A which have a global warming potential (GWP) greater than 150.

* Heat Exchanger type : Fin & Tube (Fin : Al, Tube : Cu)

1 Specifications

AR5000

Type			AR5000	AR5000	AR5000	
Model			AM036JNVDKH/EU	AM045JNVDKH/EU	AM056JNVDKH/EU	
Power Supply		Ø, #, V, Hz	1,2,220-240,50/60	1,2,220-240,50/60	1,2,220-240,50/60	
Mode			-	HP/HR	HP/HR	
Performance	Capacity (Nominal)	Cooling	kW	3.60	4.50	5.60
			Btu/h	12,300	15,400	19,100
		Heating	kW	4.00	5.00	6.30
			Btu/h	13,600	17,100	21,500
Power	Power Input (Nominal)	Cooling	W	20.00	31.00	27.00
		Heating	W	28.00	41.00	37.00
	Current Input (Nominal)	Cooling	A	0.15	0.24	0.21
		Heating	A	0.20	0.31	0.29
Fan	Motor	Type	-	Crossflow Fan	Crossflow Fan	Crossflow Fan
		Output x n	w	27 x 1	27 x 1	27 x 1
	Air Flow Rate	H/M/L (UL)	CMM	7.10 / 5.70 / 4.60	8.90 / 7.50 / 6.00	11.80 / 10.00 / 8.20
		l/s	l/s	118.33 / 95.00 / 76.67	148.33 / 125.00 / 100.00	196.67 / 166.67 / 136.67
	External Pressure	Min/Std/Max	mmAq	-	-	-
			Pa	-	-	-
Piping Connections	Liquid Pipe	Ø, mm	6.35	6.35	6.35	
		Ø, inch	1/4"	1/4"	1/4"	
	Gas Pipe	Ø, mm	12.70	12.70	12.70	
		Ø, inch	1/2"	1/2"	1/2"	
Drain Pipe	Ø, mm	ID18 HOSE	ID18 HOSE	ID18 HOSE		
Field Wiring	Power Source Wire	mm ²	1.5 - 2.5	1.5 - 2.5	1.5 - 2.5	
	Transmission Cable	mm ²	0.75 - 1.50	0.75 - 1.50	0.75 - 1.50	
Refrigerant	Type	-	R410A	R410A	R410A	
	Control Method	-	EEV INCLUDED	EEV INCLUDED	EEV INCLUDED	
Sound	Pressure	High / Mid / Low	dB(A)	37 / 34 / 30	41 / 38 / 34	39 / 36 / 33
	Power	Cooling	dB(A)	54	57	57
Dimension	Net Weight		kg	9.6	9.6	14.5
	Shipping Weight		kg	11.2	11.2	17.7
	Net Dimensions (WxHxD)		mm	826 x 261 x 261	826 x 261 x 261	1,065 x 301 x 294
	Shipping Dimensions (WxHxD)		mm	886 x 317 x 335	886 x 317 x 335	1,123 x 354 x 384
Panel Size	Panel model		-	-	-	-
	Panel Net Weight		kg	-	-	-
	Shipping Weight		kg	-	-	-
	Net Dimensions (WxHxD)		mm	-	-	-
	Shipping Dimensions (WxHxD)		mm	-	-	-
Accessories	Drain Pump	Drain Pump	- / Model	-	-	-
		Max. lifting Height / Displacement	mm/liter/h	-	-	-
	Virus Doctor		-	INCLUDED	INCLUDED	INCLUDED

* Specifications may be subject to change without prior notice for product improvement.

*1) Mode

- HP : Heat Pump, HR : Heat Recovery

*2) Nominal cooling capacities are based on;

- Indoor temperature : 27°C DB, 19°C WB

- Outdoor temperature : 35°C DB, 24°C WB, Equivalent refrigerant piping : 7.5m, Level differences : 0m

*3) Nominal heating capacities are based on;

- Indoor temperature : 20°C DB, 15°C WB

- Outdoor temperature : 7°C DB, 6°C WB, Equivalent refrigerant piping : 7.5m, Level differences : 0m

*4) Sound pressure was acquired in an anechoic room. Thus actual noise level may be different depending on the installation conditions.

*5) These products contain R410A which have a global warming potential (GWP) greater than 150.

* Heat Exchanger type : Fin & Tube (Fin : Al, Tube : Cu)

1 Specifications

AR5000

Type			AR5000		AR5000	
Model			AM071JNVDKH/EU		AM082JNVDKH/EU	
Power Supply			Ø, #, V, Hz	1,2,220-240,50/60		1,2,220-240,50/60
Mode			-	HP/HR		HP/HR
Performance	Capacity (Nominal)	Cooling	kW	7.10		8.20
			Btu/h	24,200		28,000
		Heating	kW	8.00		8.50
			Btu/h	27,300		29,000
Power	Power Input (Nominal)	Cooling	W	41.00		55.00
		Heating		53.00		72.00
	Current Input (Nominal)	Cooling	A	0.31		0.42
		Heating		0.41		0.55
Fan	Motor	Type	-	Crossflow Fan		Crossflow Fan
		Output x n	w	27 x 1		27 x 1
	Air Flow Rate	H/M/L (UL)	CMM	14.80 / 12.40 / 10.00		16.70 / 14.30 / 12.40
			l/s	246.67 / 206.67 / 166.67		278.33 / 238.33 / 206.67
	External Pressure	Min/Std/Max	mmAq	-		-
Pa			-		-	
Piping Connections	Liquid Pipe	Ø, mm	9.52		9.52	
		Ø, inch	3/8"		3/8"	
	Gas Pipe	Ø, mm	15.88		15.88	
		Ø, inch	5/8"		5/8"	
Drain Pipe	Ø, mm	ID18 HOSE		ID18 HOSE		
Field Wiring	Power Source Wire	mm ²	1.5 - 2.5		1.5 - 2.5	
	Transmission Cable	mm ²	0.75 - 1.50		0.75 - 1.50	
Refrigerant	Type	-	R410A		R410A	
	Control Method	-	EEV INCLUDED		EEV INCLUDED	
Sound	Pressure	High / Mid / Low	dB(A)	44 / 41 / 36		47 / 43 / 40
	Power	Cooling		61		65
Dimension	Net Weight		kg	14.5		14.5
	Shipping Weight		kg	17.7		17.7
	Net Dimensions (WxHxD)		mm	1,065 x 301 x 294		1,065 x 301 x 294
	Shipping Dimensions (WxHxD)		mm	1,123 x 354 x 384		1,123 x 354 x 384
Panel Size	Panel model		-	-		-
	Panel Net Weight		kg	-		-
	Shipping Weight		kg	-		-
	Net Dimensions (WxHxD)		mm	-		-
	Shipping Dimensions (WxHxD)		mm	-		-
Accessories	Drain Pump	Drain Pump	- / Model	-		-
		Max. lifting Height / Displacement	mm/liter/h	-		-
	Virus Doctor		-	INCLUDED		INCLUDED

* Specifications may be subject to change without prior notice for product improvement.

*1) Mode

- HP : Heat Pump, HR : Heat Recovery

*2) Nominal cooling capacities are based on;

- Indoor temperature : 27°C DB, 19°C WB

- Outdoor temperature : 35°C DB, 24°C WB, Equivalent refrigerant piping : 7.5m, Level differences : 0m

*3) Nominal heating capacities are based on;

- Indoor temperature : 20°C DB, 15°C WB

- Outdoor temperature : 7°C DB, 6°C WB, Equivalent refrigerant piping : 7.5m, Level differences : 0m

*4) Sound pressure was acquired in an anechoic room. Thus actual noise level may be different depending on the installation conditions.

*5) These products contain R410A which have a global warming potential (GWP) greater than 150.

* Heat Exchanger type : Fin & Tube (Fin : Al, Tube : Cu)

1 Specifications

AR5000

Type			AR5000	AR5000	AR5000	
Model			AM015JNADKH/EU	AM022JNADKH/EU	AM028JNADKH/EU	
Power Supply		Ø, #, V, Hz	1,2,220-240,50/60	1,2,220-240,50/60	1,2,220-240,50/60	
Mode			-	HP/HR	HP/HR	
Performance	Capacity (Nominal)	Cooling	kW	1.50	2.20	2.80
			Btu/h	5,100	7,500	9,600
		Heating	kW	1.70	2.50	3.20
			Btu/h	5,800	8,500	10,900
Power	Power Input (Nominal)	Cooling	W	14.00	15.00	16.00
		Heating	W	16.00	18.00	24.00
	Current Input (Nominal)	Cooling	A	0.12	0.13	0.13
		Heating	A	0.13	0.15	0.19
Fan	Motor	Type	-	Crossflow Fan	Crossflow Fan	Crossflow Fan
		Output x n	w	27 x 1	27 x 1	27 x 1
	Air Flow Rate	H/M/L (UL)	CMM	4.40 / 4.20 / 3.80	5.40 / 4.70 / 4.00	5.70 / 5.00 / 4.30
			l/s	73.33 / 70.00 / 63.33	90.00 / 78.33 / 66.67	95.00 / 83.33 / 71.67
	External Pressure	Min/Std/Max	mmAq	-	-	-
Pa			-	-	-	
Piping Connections	Liquid Pipe	Ø, mm	6.35	6.35	6.35	
		Ø, inch	1/4"	1/4"	1/4"	
	Gas Pipe	Ø, mm	12.70	12.70	12.70	
		Ø, inch	1/2"	1/2"	1/2"	
Drain Pipe	Ø, mm	ID18 HOSE	ID18 HOSE	ID18 HOSE		
Field Wiring	Power Source Wire	mm ²	1.5 - 2.5	1.5 - 2.5	1.5 - 2.5	
	Transmission Cable	mm ²	0.75 - 1.50	0.75 - 1.50	0.75 - 1.50	
Refrigerant	Type	-	R410A	R410A	R410A	
	Control Method	-	EEV NOT INCLUDED	EEV NOT INCLUDED	EEV NOT INCLUDED	
Sound	Pressure	High / Mid / Low	dB(A)	26 / 24 / 21	33 / 28 / 23	35 / 30 / 25
	Power	Cooling		44	50	53
Dimension	Net Weight		kg	7.7	7.7	7.8
	Shipping Weight		kg	9.1	9.1	9.2
	Net Dimensions (WxHxD)		mm	750 x 249 x 246	750 x 249 x 246	750 x 249 x 246
	Shipping Dimensions (WxHxD)		mm	800 x 298 x 302	800 x 298 x 302	800 x 298 x 302
Panel Size	Panel model		-	-	-	-
	Panel Net Weight		kg	-	-	-
	Shipping Weight		kg	-	-	-
	Net Dimensions (WxHxD)		mm	-	-	-
	Shipping Dimensions (WxHxD)		mm	-	-	-
Accessories	Drain Pump	Drain Pump	- / Model	-	-	-
		Max. lifting Height / Displacement	mm/liter/h	-	-	-
	Virus Doctor		-	INCLUDED	INCLUDED	INCLUDED

* Specifications may be subject to change without prior notice for product improvement.

*1) Mode

- HP : Heat Pump, HR : Heat Recovery

*2) Nominal cooling capacities are based on;

- Indoor temperature : 27°C DB, 19°C WB

- Outdoor temperature : 35°C DB, 24°C WB, Equivalent refrigerant piping : 7.5m, Level differences : 0m

*3) Nominal heating capacities are based on;

- Indoor temperature : 20°C DB, 15°C WB

- Outdoor temperature : 7°C DB, 6°C WB, Equivalent refrigerant piping : 7.5m, Level differences : 0m

*4) Sound pressure was acquired in an anechoic room. Thus actual noise level may be different depending on the installation conditions.

*5) These products contain R410A which have a global warming potential (GWP) greater than 150.

* Heat Exchanger type : Fin & Tube (Fin : Al, Tube : Cu)

1 Specifications

AR5000

Type			AR5000	AR5000	AR5000	
Model			AM036JNADKH/EU	AM045JNADKH/EU	AM056JNADKH/EU	
Power Supply		Ø, #, V, Hz	1,2,220-240,50/60	1,2,220-240,50/60	1,2,220-240,50/60	
Mode			-	HP/HR	HP/HR	
Performance	Capacity (Nominal)	Cooling	kW	3.60	4.50	5.60
			Btu/h	12,300	15,400	19,100
		Heating	kW	4.00	5.00	6.30
			Btu/h	13,600	17,100	21,500
Power	Power Input (Nominal)	Cooling	W	20.00	31.00	27.00
		Heating	W	28.00	41.00	37.00
	Current Input (Nominal)	Cooling	A	0.15	0.24	0.21
		Heating	A	0.20	0.31	0.29
Fan	Motor	Type	-	Crossflow Fan	Crossflow Fan	Crossflow Fan
		Output x n	w	27 x 1	27 x 1	27 x 1
	Air Flow Rate	H/M/L (UL)	CMM	7.10 / 5.70 / 4.60	8.90 / 7.50 / 6.00	11.80 / 10.00 / 8.20
		l/s	l/s	118.33 / 95.00 / 76.67	148.33 / 125.00 / 100.00	196.67 / 166.67 / 136.67
	External Pressure	Min/Std/Max	mmAq	-	-	-
			Pa	-	-	-
Piping Connections	Liquid Pipe	Ø, mm	6.35	6.35	6.35	
		Ø, inch	1/4"	1/4"	1/4"	
	Gas Pipe	Ø, mm	12.70	12.70	12.70	
		Ø, inch	1/2"	1/2"	1/2"	
Drain Pipe	Ø, mm	ID18 HOSE	ID18 HOSE	ID18 HOSE		
Field Wiring	Power Source Wire	mm ²	1.5 - 2.5	1.5 - 2.5	1.5 - 2.5	
	Transmission Cable	mm ²	0.75 - 1.50	0.75 - 1.50	0.75 - 1.50	
Refrigerant	Type	-	R410A	R410A	R410A	
	Control Method	-	EEV NOT INCLUDED	EEV NOT INCLUDED	EEV NOT INCLUDED	
Sound	Pressure	High / Mid / Low	dB(A)	36 / 32 / 29	40 / 37 / 33	39 / 35 / 32
	Power	Cooling	dB(A)	54	57	57
Dimension	Net Weight		kg	9.4	9.4	14.2
	Shipping Weight		kg	11.0	11.0	17.5
	Net Dimensions (WxHxD)		mm	826 x 261 x 261	826 x 261 x 261	1,065 x 301 x 294
	Shipping Dimensions (WxHxD)		mm	886 x 317 x 335	886 x 317 x 335	1,123 x 354 x 384
Panel Size	Panel model		-	-	-	-
	Panel Net Weight		kg	-	-	-
	Shipping Weight		kg	-	-	-
	Net Dimensions (WxHxD)		mm	-	-	-
	Shipping Dimensions (WxHxD)		mm	-	-	-
Accessories	Drain Pump	Drain Pump	- / Model	-	-	-
		Max. lifting Height / Displacement	mm/liter/h	-	-	-
	Virus Doctor		-	INCLUDED	INCLUDED	INCLUDED

* Specifications may be subject to change without prior notice for product improvement.

*1) Mode

- HP : Heat Pump, HR : Heat Recovery

*2) Nominal cooling capacities are based on;

- Indoor temperature : 27°C DB, 19°C WB

- Outdoor temperature : 35°C DB, 24°C WB, Equivalent refrigerant piping : 7.5m, Level differences : 0m

*3) Nominal heating capacities are based on;

- Indoor temperature : 20°C DB, 15°C WB

- Outdoor temperature : 7°C DB, 6°C WB, Equivalent refrigerant piping : 7.5m, Level differences : 0m

*4) Sound pressure was acquired in an anechoic room. Thus actual noise level may be different depending on the installation conditions.

*5) These products contain R410A which have a global warming potential (GWP) greater than 150.

* Heat Exchanger type : Fin & Tube (Fin : Al, Tube : Cu)

1 Specifications

AR5000

Type			AR5000		AR5000	
Model			AM071JNADKH/EU		AM082JNADKH/EU	
Power Supply			Ø, #, V, Hz	1,2,220-240,50/60		1,2,220-240,50/60
Mode			-	HP/HR		HP/HR
Performance	Capacity (Nominal)	Cooling	kW	7.10		8.20
			Btu/h	24,200		28,000
		Heating	kW	8.00		8.50
			Btu/h	27,300		29,000
Power	Power Input (Nominal)	Cooling	W	41.00		55.00
		Heating		53.00		72.00
	Current Input (Nominal)	Cooling	A	0.31		0.42
		Heating		0.41		0.55
Fan	Motor	Type	-	Crossflow Fan		Crossflow Fan
		Output x n	w	27 x 1		27 x 1
	Air Flow Rate	H/M/L (UL)	CMM	14.80 / 12.40 / 10.00		16.70 / 14.30 / 12.40
			l/s	246.67 / 206.67 / 166.67		278.33 / 238.33 / 206.67
	External Pressure	Min/Std/Max	mmAq	-		-
Pa			-		-	
Piping Connections	Liquid Pipe		Ø, mm	9.52		9.52
			Ø, inch	3/8"		3/8"
	Gas Pipe		Ø, mm	15.88		15.88
			Ø, inch	5/8"		5/8"
	Drain Pipe		Ø, mm	ID18 HOSE		ID18 HOSE
Field Wiring	Power Source Wire		mm ²	1.5 - 2.5		1.5 - 2.5
	Transmission Cable		mm ²	0.75 - 1.50		0.75 - 1.50
Refrigerant	Type	-	-	R410A		R410A
	Control Method	-	-	EEV NOT INCLUDED		EEV NOT INCLUDED
Sound	Pressure	High / Mid / Low	dB(A)	44 / 40 / 36		47 / 42 / 40
	Power	Cooling		61		65
Dimension	Net Weight		kg	14.2		14.2
	Shipping Weight		kg	17.5		17.5
	Net Dimensions (WxHxD)		mm	1,065 x 301 x 294		1,065 x 301 x 294
	Shipping Dimensions (WxHxD)		mm	1,123 x 354 x 384		1,123 x 354 x 384
Panel Size	Panel model		-	-		-
	Panel Net Weight		kg	-		-
	Shipping Weight		kg	-		-
	Net Dimensions (WxHxD)		mm	-		-
	Shipping Dimensions (WxHxD)		mm	-		-
Accessories	Drain Pump	Drain Pump	- / Model	-		-
		Max. lifting Height / Displacement	mm/liter/h	-		-
	Virus Doctor		-	-	INCLUDED	

* Specifications may be subject to change without prior notice for product improvement.

*1) Mode

- HP : Heat Pump, HR : Heat Recovery

*2) Nominal cooling capacities are based on;

- Indoor temperature : 27°C DB, 19°C WB

- Outdoor temperature : 35°C DB, 24°C WB, Equivalent refrigerant piping : 7.5m, Level differences : 0m

*3) Nominal heating capacities are based on;

- Indoor temperature : 20°C DB, 15°C WB

- Outdoor temperature : 7°C DB, 6°C WB, Equivalent refrigerant piping : 7.5m, Level differences : 0m

*4) Sound pressure was acquired in an anechoic room. Thus actual noise level may be different depending on the installation conditions.

*5) These products contain R410A which have a global warming potential (GWP) greater than 150.

* Heat Exchanger type : Fin & Tube (Fin : Al, Tube : Cu)

2 Capacity table

AR5000

Cooling

TC : Total Capacity, SHC : Sensible Heat Capacity

Capacity Index	Outdoor Air Temp. (°C, DB)	Indoor temperature													
		20(°C, DB)		23(°C, DB)		26(°C, DB)		27(°C, DB)		28(°C, DB)		30(°C, DB)		32(°C, DB)	
		14(°C, WB)		16(°C, WB)		18(°C, WB)		19(°C, WB)		20(°C, WB)		22(°C, WB)		24(°C, WB)	
		TC	SHC	TC	SHC	TC	SHC	TC	SHC	TC	SHC	TC	SHC	TC	SHC
015	10	1.0	0.9	1.2	1.0	1.4	1.0	1.5	1.0	1.6	1.0	1.7	1.1	1.8	1.0
	12	1.0	0.9	1.2	1.0	1.4	1.0	1.5	1.0	1.6	1.0	1.7	1.1	1.8	1.0
	14	1.0	0.9	1.2	1.0	1.4	1.0	1.5	1.0	1.6	1.0	1.7	1.1	1.8	1.0
	16	1.0	0.9	1.2	1.0	1.4	1.0	1.5	1.0	1.6	1.0	1.6	1.1	1.8	1.0
	18	1.0	0.9	1.2	1.0	1.4	1.0	1.5	1.0	1.6	1.0	1.6	1.1	1.8	1.0
	20	1.0	0.9	1.2	1.0	1.4	1.0	1.5	1.0	1.6	1.0	1.6	1.1	1.8	1.0
	21	1.0	0.9	1.2	1.0	1.4	1.0	1.5	1.0	1.6	1.0	1.6	1.1	1.8	1.0
	23	1.0	0.9	1.2	1.0	1.4	1.0	1.5	1.0	1.6	1.0	1.6	1.1	1.8	1.0
	25	1.0	0.9	1.2	1.0	1.4	1.0	1.5	1.0	1.6	1.0	1.6	1.1	1.8	1.0
	27	1.0	0.9	1.2	1.0	1.4	1.0	1.5	1.0	1.6	1.0	1.6	1.1	1.8	1.0
	29	1.0	0.9	1.2	1.0	1.4	1.0	1.5	1.0	1.6	1.0	1.6	1.1	1.8	1.0
	31	1.0	0.9	1.2	1.0	1.4	1.0	1.5	1.0	1.6	1.0	1.6	1.1	1.8	1.0
	33	1.0	0.9	1.2	1.0	1.4	1.0	1.5	1.0	1.6	1.0	1.6	1.1	1.8	1.0
	35	1.0	0.9	1.2	1.0	1.4	1.0	1.5	1.0	1.6	1.0	1.6	1.1	1.8	1.0
	37	1.0	0.9	1.2	1.0	1.4	1.0	1.5	1.0	1.6	1.0	1.6	1.1	1.8	1.0
	39	1.0	0.9	1.2	1.0	1.4	1.0	1.5	1.0	1.6	1.0	1.6	1.1	1.7	0.9
42	1.0	0.9	1.2	1.0	1.4	1.0	1.5	1.0	1.6	1.0	1.6	1.1	1.7	0.9	
44	1.0	0.9	1.2	1.0	1.4	1.0	1.4	1.0	1.5	1.0	1.5	1.0	1.6	0.8	
46	1.0	0.9	1.2	1.0	1.3	1.0	1.4	0.9	1.5	0.9	1.5	1.0	1.6	0.8	
48	1.0	0.9	1.2	1.0	1.3	0.9	1.3	0.9	1.5	0.9	1.4	1.0	1.5	0.8	
022	10	1.5	1.3	1.8	1.5	2.1	1.5	2.2	1.5	2.3	1.5	2.5	1.6	2.6	1.4
	12	1.5	1.3	1.8	1.5	2.1	1.5	2.2	1.5	2.3	1.5	2.5	1.6	2.6	1.4
	14	1.5	1.3	1.8	1.5	2.1	1.5	2.2	1.5	2.3	1.5	2.5	1.6	2.6	1.4
	16	1.5	1.3	1.8	1.5	2.1	1.5	2.2	1.5	2.3	1.5	2.4	1.5	2.6	1.4
	18	1.5	1.3	1.8	1.5	2.1	1.5	2.2	1.5	2.3	1.5	2.4	1.5	2.6	1.4
	20	1.5	1.3	1.8	1.5	2.1	1.5	2.2	1.5	2.3	1.5	2.4	1.5	2.6	1.4
	21	1.5	1.3	1.8	1.5	2.1	1.5	2.2	1.5	2.3	1.5	2.4	1.5	2.6	1.4
	23	1.5	1.3	1.8	1.5	2.1	1.5	2.2	1.5	2.3	1.5	2.4	1.5	2.6	1.4
	25	1.5	1.3	1.8	1.5	2.1	1.5	2.2	1.5	2.3	1.5	2.4	1.5	2.6	1.4
	27	1.5	1.3	1.8	1.5	2.1	1.5	2.2	1.5	2.3	1.5	2.4	1.5	2.6	1.4
	29	1.5	1.3	1.8	1.5	2.1	1.5	2.2	1.5	2.3	1.5	2.4	1.5	2.6	1.4
	31	1.5	1.3	1.8	1.5	2.1	1.5	2.2	1.5	2.3	1.5	2.4	1.5	2.6	1.4
	33	1.5	1.3	1.8	1.5	2.1	1.5	2.2	1.5	2.3	1.5	2.4	1.5	2.6	1.4
	35	1.5	1.3	1.8	1.5	2.1	1.5	2.2	1.5	2.3	1.5	2.4	1.5	2.6	1.4
	37	1.5	1.3	1.8	1.5	2.1	1.5	2.2	1.5	2.3	1.5	2.4	1.5	2.6	1.4
	39	1.5	1.3	1.8	1.5	2.1	1.5	2.2	1.5	2.3	1.5	2.4	1.5	2.5	1.3
42	1.5	1.3	1.8	1.5	2.1	1.5	2.2	1.5	2.3	1.5	2.4	1.5	2.4	1.3	
44	1.5	1.3	1.8	1.5	2.0	1.4	2.1	1.4	2.2	1.4	2.3	1.4	2.4	1.2	
46	1.5	1.3	1.8	1.5	2.0	1.4	2.0	1.4	2.1	1.4	2.2	1.4	2.3	1.2	
48	1.5	1.3	1.8	1.5	2.0	1.4	2.0	1.3	2.1	1.4	2.1	1.3	2.2	1.1	
028	10	1.9	1.6	2.3	1.8	2.6	2.0	2.8	1.9	2.9	1.9	3.1	1.9	3.4	1.9
	12	1.9	1.6	2.3	1.8	2.6	2.0	2.8	1.9	2.9	1.9	3.1	1.9	3.3	1.8
	14	1.9	1.6	2.3	1.8	2.6	2.0	2.8	1.9	2.9	1.9	3.1	1.9	3.3	1.8
	16	1.9	1.6	2.3	1.8	2.6	2.0	2.8	1.9	2.9	1.9	3.1	1.9	3.3	1.8
	18	1.9	1.6	2.3	1.8	2.6	2.0	2.8	1.9	2.9	1.9	3.1	1.9	3.3	1.8
	20	1.9	1.6	2.3	1.8	2.6	2.0	2.8	1.9	2.9	1.9	3.1	1.9	3.3	1.8
	21	1.9	1.6	2.3	1.8	2.6	2.0	2.8	1.9	2.9	1.9	3.1	1.9	3.3	1.8
	23	1.9	1.6	2.3	1.8	2.6	2.0	2.8	1.9	2.9	1.9	3.1	1.9	3.3	1.8
	25	1.9	1.6	2.3	1.8	2.6	2.0	2.8	1.9	2.9	1.9	3.1	1.9	3.3	1.8
	27	1.9	1.6	2.3	1.8	2.6	2.0	2.8	1.9	2.9	1.9	3.1	1.9	3.3	1.8
	29	1.9	1.6	2.3	1.8	2.6	2.0	2.8	1.9	2.9	1.9	3.1	1.9	3.3	1.8
	31	1.9	1.6	2.3	1.8	2.6	2.0	2.8	1.9	2.9	1.9	3.1	1.9	3.3	1.8
	33	1.9	1.6	2.3	1.8	2.6	2.0	2.8	1.9	2.9	1.9	3.1	1.9	3.3	1.8
	35	1.9	1.6	2.3	1.8	2.6	2.0	2.8	1.9	2.9	1.9	3.1	1.9	3.3	1.8
	37	1.9	1.6	2.3	1.8	2.6	2.0	2.8	1.9	2.9	1.9	3.1	1.9	3.3	1.8
	39	1.9	1.6	2.3	1.8	2.6	2.0	2.8	1.9	2.9	1.9	3.0	1.8	3.2	1.7
42	1.9	1.6	2.3	1.8	2.6	2.0	2.8	1.9	2.9	1.9	2.9	1.8	3.1	1.7	
44	1.9	1.6	2.3	1.8	2.5	1.9	2.7	1.8	2.8	1.8	2.8	1.7	3.0	1.6	
46	1.9	1.6	2.3	1.8	2.5	1.9	2.6	1.8	2.7	1.8	2.7	1.6	2.9	1.6	
48	1.9	1.6	2.2	1.8	2.4	1.9	2.5	1.7	2.6	1.7	2.7	1.6	2.8	1.5	

2 Capacity table

AR5000

Cooling

TC : Total Capacity, SHC : Sensible Heat Capacity

Capacity Index	Outdoor Air Temp. (°C, DB)	Indoor temperature													
		20(°C, DB)		23(°C, DB)		26(°C, DB)		27(°C, DB)		28(°C, DB)		30(°C, DB)		32(°C, DB)	
		14(°C, WB)		16(°C, WB)		18(°C, WB)		19(°C, WB)		20(°C, WB)		22(°C, WB)		24(°C, WB)	
		TC	SHC	TC	SHC	TC	SHC	TC	SHC	TC	SHC	TC	SHC	TC	SHC
036	10	2.5	2.1	2.9	2.2	3.4	2.3	3.6	2.4	3.7	2.4	4.0	2.4	4.3	2.3
	12	2.5	2.1	2.9	2.2	3.4	2.3	3.6	2.4	3.7	2.4	4.0	2.4	4.3	2.3
	14	2.5	2.1	2.9	2.2	3.4	2.3	3.6	2.4	3.7	2.4	4.0	2.4	4.3	2.3
	16	2.5	2.1	2.9	2.2	3.4	2.3	3.6	2.4	3.7	2.4	4.0	2.4	4.3	2.3
	18	2.5	2.1	2.9	2.2	3.4	2.3	3.6	2.4	3.7	2.4	4.0	2.4	4.3	2.3
	20	2.5	2.1	2.9	2.2	3.4	2.3	3.6	2.4	3.7	2.4	4.0	2.4	4.2	2.3
	21	2.5	2.1	2.9	2.2	3.4	2.3	3.6	2.4	3.7	2.4	4.0	2.4	4.2	2.3
	23	2.5	2.1	2.9	2.2	3.4	2.3	3.6	2.4	3.7	2.4	4.0	2.4	4.2	2.3
	25	2.5	2.1	2.9	2.2	3.4	2.3	3.6	2.4	3.7	2.4	4.0	2.4	4.2	2.3
	27	2.5	2.1	2.9	2.2	3.4	2.3	3.6	2.4	3.7	2.4	4.0	2.4	4.2	2.3
	29	2.5	2.1	2.9	2.2	3.4	2.3	3.6	2.4	3.7	2.4	4.0	2.4	4.2	2.3
	31	2.5	2.1	2.9	2.2	3.4	2.3	3.6	2.4	3.7	2.4	4.0	2.4	4.2	2.3
	33	2.5	2.1	2.9	2.2	3.4	2.3	3.6	2.4	3.7	2.4	4.0	2.4	4.2	2.3
	35	2.5	2.1	2.9	2.2	3.4	2.3	3.6	2.4	3.7	2.4	4.0	2.4	4.2	2.3
	37	2.5	2.1	2.9	2.2	3.4	2.3	3.6	2.4	3.7	2.4	3.9	2.3	4.2	2.3
	39	2.5	2.1	2.9	2.2	3.4	2.3	3.6	2.4	3.7	2.4	3.9	2.3	4.1	2.2
42	2.5	2.1	2.9	2.2	3.4	2.3	3.6	2.4	3.7	2.4	3.8	2.3	4.0	2.1	
44	2.5	2.1	2.9	2.2	3.3	2.2	3.4	2.3	3.6	2.3	3.7	2.2	3.9	2.1	
46	2.5	2.1	2.9	2.2	3.2	2.2	3.3	2.2	3.4	2.2	3.6	2.1	3.8	2.0	
48	2.5	2.1	2.8	2.2	3.2	2.1	3.2	2.2	3.4	2.2	3.5	2.0	3.6	1.9	
045	10	3.1	2.4	3.7	2.7	4.3	2.9	4.5	3.0	4.7	3.0	5.1	3.1	5.4	2.8
	12	3.1	2.4	3.7	2.7	4.3	2.9	4.5	3.0	4.7	3.0	5.1	3.1	5.4	2.8
	14	3.1	2.4	3.7	2.7	4.3	2.9	4.5	3.0	4.7	3.0	5.0	3.0	5.4	2.8
	16	3.1	2.4	3.7	2.7	4.3	2.9	4.5	3.0	4.7	3.0	5.0	3.0	5.3	2.8
	18	3.1	2.4	3.7	2.7	4.3	2.9	4.5	3.0	4.7	3.0	5.0	3.0	5.3	2.8
	20	3.1	2.4	3.7	2.7	4.3	2.9	4.5	3.0	4.7	3.0	5.0	3.0	5.3	2.8
	21	3.1	2.4	3.7	2.7	4.3	2.9	4.5	3.0	4.7	3.0	5.0	3.0	5.3	2.8
	23	3.1	2.4	3.7	2.7	4.3	2.9	4.5	3.0	4.7	3.0	5.0	3.0	5.3	2.8
	25	3.1	2.4	3.7	2.7	4.3	2.9	4.5	3.0	4.7	3.0	5.0	3.0	5.3	2.8
	27	3.1	2.4	3.7	2.7	4.3	2.9	4.5	3.0	4.7	3.0	5.0	3.0	5.3	2.8
	29	3.1	2.4	3.7	2.7	4.3	2.9	4.5	3.0	4.7	3.0	5.0	3.0	5.3	2.8
	31	3.1	2.4	3.7	2.7	4.3	2.9	4.5	3.0	4.7	3.0	5.0	3.0	5.3	2.8
	33	3.1	2.4	3.7	2.7	4.3	2.9	4.5	3.0	4.7	3.0	5.0	3.0	5.3	2.8
	35	3.1	2.4	3.7	2.7	4.3	2.9	4.5	3.0	4.7	3.0	5.0	3.0	5.3	2.8
	37	3.1	2.4	3.7	2.7	4.3	2.9	4.5	3.0	4.7	3.0	4.9	2.9	5.2	2.7
	39	3.1	2.4	3.7	2.7	4.3	2.9	4.5	3.0	4.7	3.0	4.9	2.9	5.1	2.6
42	3.1	2.4	3.7	2.7	4.2	2.9	4.4	3.0	4.6	3.0	4.8	2.9	5.0	2.5	
44	3.1	2.4	3.7	2.7	4.1	2.8	4.3	2.9	4.5	2.9	4.6	2.8	4.8	2.5	
46	3.1	2.4	3.7	2.7	4.0	2.8	4.2	2.8	4.3	2.8	4.5	2.7	4.7	2.4	
48	3.1	2.3	3.6	2.6	4.0	2.7	4.0	2.7	4.3	2.7	4.3	2.6	4.5	2.3	
056	10	3.9	3.0	4.6	3.4	5.3	3.7	5.6	3.8	5.8	3.8	6.3	3.9	6.7	3.6
	12	3.9	3.0	4.6	3.4	5.3	3.7	5.6	3.8	5.8	3.8	6.3	3.9	6.7	3.6
	14	3.9	3.0	4.6	3.4	5.3	3.7	5.6	3.8	5.8	3.8	6.2	3.8	6.7	3.6
	16	3.9	3.0	4.6	3.4	5.3	3.7	5.6	3.8	5.8	3.8	6.2	3.8	6.6	3.5
	18	3.9	3.0	4.6	3.4	5.3	3.7	5.6	3.8	5.8	3.8	6.2	3.8	6.6	3.5
	20	3.9	3.0	4.6	3.4	5.3	3.7	5.6	3.8	5.8	3.8	6.2	3.8	6.6	3.5
	21	3.9	3.0	4.6	3.4	5.3	3.7	5.6	3.8	5.8	3.8	6.2	3.8	6.6	3.5
	23	3.9	3.0	4.6	3.4	5.3	3.7	5.6	3.8	5.8	3.8	6.2	3.8	6.6	3.5
	25	3.9	3.0	4.6	3.4	5.3	3.7	5.6	3.8	5.8	3.8	6.2	3.8	6.6	3.5
	27	3.9	3.0	4.6	3.4	5.3	3.7	5.6	3.8	5.8	3.8	6.2	3.8	6.6	3.5
	29	3.9	3.0	4.6	3.4	5.3	3.7	5.6	3.8	5.8	3.8	6.2	3.8	6.6	3.5
	31	3.9	3.0	4.6	3.4	5.3	3.7	5.6	3.8	5.8	3.8	6.2	3.8	6.6	3.5
	33	3.9	3.0	4.6	3.4	5.3	3.7	5.6	3.8	5.8	3.8	6.2	3.8	6.6	3.5
	35	3.9	3.0	4.6	3.4	5.3	3.7	5.6	3.8	5.8	3.8	6.2	3.8	6.6	3.5
	37	3.9	3.0	4.6	3.4	5.3	3.7	5.6	3.8	5.8	3.8	6.1	3.7	6.5	3.4
	39	3.9	3.0	4.6	3.4	5.3	3.7	5.6	3.8	5.8	3.8	6.1	3.7	6.4	3.3
42	3.9	3.0	4.6	3.4	5.3	3.7	5.5	3.7	5.7	3.8	6.0	3.6	6.2	3.2	
44	3.9	3.0	4.6	3.4	5.1	3.6	5.3	3.6	5.6	3.6	5.8	3.5	6.0	3.1	
46	3.9	3.0	4.6	3.4	5.0	3.5	5.2	3.5	5.4	3.5	5.6	3.4	5.9	3.0	
48	3.9	3.0	4.5	3.3	5.0	3.5	5.0	3.4	5.3	3.5	5.4	3.3	5.7	2.9	

2 Capacity table

AR5000

Cooling

TC : Total Capacity, SHC : Sensible Heat Capacity

Capacity Index	Outdoor Air Temp. (°C, DB)	Indoor temperature													
		20(°C, DB)		23(°C, DB)		26(°C, DB)		27(°C, DB)		28(°C, DB)		30(°C, DB)		32(°C, DB)	
		14(°C, WB)		16(°C, WB)		18(°C, WB)		19(°C, WB)		20(°C, WB)		22(°C, WB)		24(°C, WB)	
		TC	SHC	TC	SHC	TC	SHC	TC	SHC	TC	SHC	TC	SHC	TC	SHC
071	10	4.9	3.9	5.7	4.3	6.7	4.7	7.1	4.8	7.4	4.8	7.9	4.8	8.6	4.6
	12	4.9	3.9	5.7	4.3	6.7	4.7	7.1	4.8	7.4	4.8	7.9	4.8	8.5	4.5
	14	4.9	3.9	5.7	4.3	6.7	4.7	7.1	4.8	7.4	4.8	7.9	4.8	8.5	4.5
	16	4.9	3.9	5.7	4.3	6.7	4.7	7.1	4.8	7.4	4.8	7.9	4.8	8.5	4.5
	18	4.9	3.9	5.7	4.3	6.7	4.7	7.1	4.8	7.3	4.8	7.8	4.7	8.4	4.4
	20	4.9	3.9	5.7	4.3	6.7	4.7	7.1	4.8	7.3	4.8	7.8	4.7	8.4	4.4
	21	4.9	3.9	5.7	4.3	6.7	4.7	7.1	4.8	7.3	4.8	7.8	4.7	8.4	4.4
	23	4.9	3.9	5.7	4.3	6.7	4.7	7.1	4.8	7.3	4.8	7.8	4.7	8.4	4.4
	25	4.9	3.9	5.7	4.3	6.7	4.7	7.1	4.8	7.3	4.8	7.8	4.7	8.4	4.4
	27	4.9	3.9	5.7	4.3	6.7	4.7	7.1	4.8	7.3	4.8	7.8	4.7	8.4	4.4
	29	4.9	3.9	5.7	4.3	6.7	4.7	7.1	4.8	7.3	4.8	7.8	4.7	8.4	4.4
	31	4.9	3.9	5.7	4.3	6.7	4.7	7.1	4.8	7.3	4.8	7.8	4.7	8.4	4.4
	33	4.9	3.9	5.7	4.3	6.7	4.7	7.1	4.8	7.3	4.8	7.8	4.7	8.4	4.4
	35	4.9	3.9	5.7	4.3	6.7	4.7	7.1	4.8	7.3	4.8	7.8	4.7	8.4	4.4
	37	4.9	3.9	5.7	4.3	6.7	4.7	7.1	4.8	7.3	4.8	7.8	4.7	8.2	4.3
	39	4.9	3.9	5.7	4.3	6.7	4.7	7.1	4.8	7.3	4.8	7.7	4.6	8.0	4.2
42	4.9	3.9	5.7	4.3	6.6	4.7	7.0	4.7	7.2	4.7	7.6	4.5	7.8	4.1	
44	4.9	3.9	5.7	4.3	6.5	4.5	6.8	4.6	7.0	4.6	7.3	4.3	7.6	3.9	
46	4.9	3.9	5.7	4.2	6.3	4.5	6.6	4.4	6.8	4.5	7.1	4.2	7.4	3.8	
48	4.8	3.8	5.6	4.2	6.2	4.4	6.4	4.3	6.7	4.4	6.9	4.1	7.1	3.7	
082	10	5.7	4.4	6.7	5.0	7.8	5.4	8.2	5.6	8.5	5.6	9.2	5.7	9.8	5.3
	12	5.7	4.4	6.7	5.0	7.8	5.4	8.2	5.6	8.5	5.6	9.2	5.7	9.8	5.3
	14	5.7	4.4	6.7	5.0	7.8	5.4	8.2	5.6	8.5	5.6	9.1	5.6	9.8	5.3
	16	5.7	4.4	6.7	5.0	7.8	5.4	8.2	5.6	8.5	5.6	9.1	5.6	9.7	5.1
	18	5.7	4.4	6.7	5.0	7.8	5.4	8.2	5.6	8.5	5.6	9.1	5.6	9.7	5.1
	20	5.7	4.4	6.7	5.0	7.8	5.4	8.2	5.6	8.5	5.6	9.1	5.6	9.7	5.1
	21	5.7	4.4	6.7	5.0	7.8	5.4	8.2	5.6	8.5	5.6	9.1	5.6	9.7	5.1
	23	5.7	4.4	6.7	5.0	7.8	5.4	8.2	5.6	8.5	5.6	9.1	5.6	9.7	5.1
	25	5.7	4.4	6.7	5.0	7.8	5.4	8.2	5.6	8.5	5.6	9.1	5.6	9.7	5.1
	27	5.7	4.4	6.7	5.0	7.8	5.4	8.2	5.6	8.5	5.6	9.1	5.6	9.7	5.1
	29	5.7	4.4	6.7	5.0	7.8	5.4	8.2	5.6	8.5	5.6	9.1	5.6	9.7	5.1
	31	5.7	4.4	6.7	5.0	7.8	5.4	8.2	5.6	8.5	5.6	9.1	5.6	9.7	5.1
	33	5.7	4.4	6.7	5.0	7.8	5.4	8.2	5.6	8.5	5.6	9.1	5.6	9.7	5.1
	35	5.7	4.4	6.7	5.0	7.8	5.4	8.2	5.6	8.5	5.6	9.1	5.6	9.7	5.1
	37	5.7	4.4	6.7	5.0	7.8	5.4	8.2	5.6	8.5	5.6	8.9	5.4	9.5	5.0
	39	5.7	4.4	6.7	5.0	7.8	5.4	8.2	5.6	8.5	5.6	8.9	5.4	9.4	4.8
42	5.7	4.4	6.7	5.0	7.7	5.4	8.1	5.5	8.4	5.5	8.7	5.3	9.2	4.7	
44	5.7	4.4	6.7	5.0	7.5	5.2	7.8	5.3	8.2	5.4	8.4	5.1	8.8	4.5	
46	5.7	4.4	6.6	5.0	7.4	5.1	7.6	5.2	7.9	5.2	8.1	4.9	8.6	4.4	
48	5.6	4.3	6.6	4.9	7.3	5.0	7.4	5.0	7.8	5.1	7.9	4.8	8.3	4.2	

2 Capacity table

AR5000

Heating

TC : Total Capacity

Capacity Index	Outdoor Air Temp. (°C)		Indoor temperature (°C,DB)				
			16(°C,DB)	18(°C,DB)	20(°C,DB)	22(°C,DB)	24(°C,DB)
	DB	WB	TC kW	TC kW	TC kW	TC kW	TC kW
015	-19.8	-20.0	1.0	1.0	1.0	1.0	1.0
	-18.8	-19.0	1.0	1.0	1.0	1.0	1.0
	-16.7	-17.0	1.1	1.1	1.1	1.1	1.1
	-14.7	-15.0	1.2	1.1	1.1	1.1	1.1
	-12.6	-13.0	1.2	1.2	1.2	1.2	1.2
	-10.5	-11.0	1.4	1.4	1.3	1.3	1.3
	-9.5	-10.0	1.4	1.4	1.3	1.3	1.3
	-8.5	-9.1	1.5	1.5	1.4	1.4	1.4
	-7.0	-7.6	1.6	1.5	1.5	1.4	1.4
	-5.0	-5.6	1.6	1.6	1.6	1.5	1.5
	-3.0	-3.7	1.7	1.7	1.6	1.6	1.5
	0.0	-0.7	1.8	1.7	1.7	1.6	1.5
	3.0	2.2	1.8	1.8	1.7	1.6	1.5
	5.0	4.1	1.9	1.8	1.7	1.6	1.5
	7.0	6.0	1.9	1.8	1.7	1.6	1.5
9.0	7.9	2.0	1.8	1.7	1.6	1.5	
11.0	9.8	2.0	1.8	1.7	1.6	1.5	
13.0	11.8	2.0	1.8	1.7	1.6	1.5	
15.0	13.7	2.0	1.8	1.7	1.6	1.5	
022	-19.8	-20.0	1.5	1.5	1.5	1.5	1.5
	-18.8	-19.0	1.5	1.5	1.5	1.5	1.5
	-16.7	-17.0	1.6	1.6	1.6	1.6	1.6
	-14.7	-15.0	1.7	1.6	1.6	1.6	1.6
	-12.6	-13.0	1.8	1.8	1.8	1.8	1.7
	-10.5	-11.0	2.0	2.0	1.9	1.9	1.9
	-9.5	-10.0	2.1	2.0	2.0	1.9	1.9
	-8.5	-9.1	2.2	2.1	2.1	2.0	2.0
	-7.0	-7.6	2.3	2.2	2.2	2.0	2.0
	-5.0	-5.6	2.4	2.3	2.3	2.2	2.2
	-3.0	-3.7	2.5	2.5	2.4	2.3	2.2
	0.0	-0.7	2.6	2.5	2.5	2.3	2.2
	3.0	2.2	2.7	2.6	2.5	2.3	2.2
	5.0	4.1	2.8	2.7	2.5	2.3	2.2
	7.0	6.0	2.8	2.7	2.5	2.3	2.2
9.0	7.9	3.0	2.7	2.5	2.3	2.2	
11.0	9.8	3.0	2.7	2.5	2.3	2.2	
13.0	11.8	3.0	2.7	2.5	2.3	2.2	
15.0	13.7	3.0	2.7	2.5	2.3	2.2	
028	-19.8	-20.0	1.9	1.9	1.9	1.9	1.9
	-18.8	-19.0	1.9	1.9	1.9	1.9	1.9
	-16.7	-17.0	2.0	2.0	2.0	2.0	1.9
	-14.7	-15.0	2.1	2.1	2.0	2.0	1.9
	-12.6	-13.0	2.2	2.2	2.2	2.1	2.1
	-10.5	-11.0	2.3	2.3	2.3	2.3	2.2
	-9.5	-10.0	2.3	2.3	2.3	2.3	2.2
	-8.5	-9.1	2.4	2.4	2.4	2.4	2.3
	-7.0	-7.6	2.5	2.4	2.4	2.4	2.3
	-5.0	-5.6	2.6	2.6	2.5	2.5	2.4
	-3.0	-3.7	2.8	2.7	2.7	2.6	2.5
	0.0	-0.7	2.9	2.8	2.8	2.7	2.6
	3.0	2.2	3.0	3.0	2.9	2.8	2.7
	5.0	4.1	3.2	3.1	3.1	2.9	2.7
	7.0	6.0	3.3	3.2	3.2	3.0	2.7
9.0	7.9	3.4	3.3	3.2	3.0	2.7	
11.0	9.8	3.5	3.3	3.2	3.0	2.7	
13.0	11.8	3.6	3.4	3.2	3.0	2.7	
15.0	13.7	3.7	3.4	3.2	3.0	2.7	

2 Capacity table

AR5000

Heating

TC : Total Capacity

Capacity Index	Outdoor Air Temp. (°C)		Indoor temperature (°C,DB)				
			16(°C,DB)	18(°C,DB)	20(°C,DB)	22(°C,DB)	24(°C,DB)
	DB	WB	TC kW	TC kW	TC kW	TC kW	TC kW
036	-19.8	-20.0	2.4	2.4	2.3	2.3	2.3
	-18.8	-19.0	2.5	2.4	2.3	2.3	2.3
	-16.7	-17.0	2.6	2.5	2.4	2.4	2.3
	-14.7	-15.0	2.7	2.6	2.5	2.5	2.4
	-12.6	-13.0	2.8	2.7	2.7	2.6	2.6
	-10.5	-11.0	2.9	2.9	2.9	2.8	2.8
	-9.5	-10.0	2.9	2.9	2.9	2.8	2.8
	-8.5	-9.1	3.0	3.0	3.0	2.9	2.9
	-7.0	-7.6	3.1	3.1	3.0	3.0	2.9
	-5.0	-5.6	3.3	3.2	3.2	3.1	3.0
	-3.0	-3.7	3.4	3.4	3.3	3.2	3.1
	0.0	-0.7	3.6	3.6	3.5	3.4	3.2
	3.0	2.2	3.8	3.7	3.7	3.5	3.4
	5.0	4.1	3.9	3.9	3.8	3.6	3.4
	7.0	6.0	4.1	4.1	4.0	3.7	3.4
9.0	7.9	4.2	4.1	4.0	3.7	3.4	
11.0	9.8	4.4	4.2	4.0	3.7	3.4	
13.0	11.8	4.5	4.2	4.0	3.7	3.4	
15.0	13.7	4.6	4.3	4.0	3.7	3.4	
045	-19.8	-20.0	3.1	3.0	3.0	2.9	2.9
	-18.8	-19.0	3.1	3.1	3.1	3.0	3.0
	-16.7	-17.0	3.2	3.2	3.1	3.0	3.0
	-14.7	-15.0	3.3	3.3	3.2	3.1	3.0
	-12.6	-13.0	3.5	3.4	3.3	3.3	3.2
	-10.5	-11.0	3.6	3.6	3.5	3.5	3.4
	-9.5	-10.0	3.7	3.7	3.6	3.5	3.5
	-8.5	-9.1	3.8	3.7	3.7	3.6	3.5
	-7.0	-7.6	3.9	3.8	3.8	3.7	3.6
	-5.0	-5.6	4.1	4.1	4.0	3.9	3.7
	-3.0	-3.7	4.3	4.2	4.2	4.1	3.9
	0.0	-0.7	4.5	4.4	4.4	4.2	4.0
	3.0	2.2	4.7	4.7	4.6	4.4	4.2
	5.0	4.1	4.9	4.8	4.8	4.5	4.2
	7.0	6.0	5.2	5.1	5.0	4.6	4.2
9.0	7.9	5.3	5.2	5.0	4.6	4.2	
11.0	9.8	5.5	5.2	5.0	4.6	4.2	
13.0	11.8	5.6	5.3	5.0	4.6	4.2	
15.0	13.7	5.8	5.4	5.0	4.6	4.2	
056	-19.8	-20.0	3.9	3.8	3.8	3.7	3.7
	-18.8	-19.0	3.9	3.9	3.8	3.7	3.7
	-16.7	-17.0	4.0	4.0	3.9	3.8	3.8
	-14.7	-15.0	4.2	4.1	4.0	3.9	3.8
	-12.6	-13.0	4.4	4.3	4.2	4.1	4.0
	-10.5	-11.0	4.6	4.5	4.4	4.4	4.3
	-9.5	-10.0	4.7	4.6	4.6	4.5	4.4
	-8.5	-9.1	4.8	4.7	4.7	4.6	4.5
	-7.0	-7.6	4.9	4.8	4.8	4.7	4.5
	-5.0	-5.6	5.2	5.1	5.0	4.9	4.7
	-3.0	-3.7	5.4	5.3	5.3	5.1	4.9
	0.0	-0.7	5.7	5.6	5.5	5.3	5.0
	3.0	2.2	5.9	5.9	5.8	5.6	5.3
	5.0	4.1	6.2	6.1	6.0	5.7	5.3
	7.0	6.0	6.5	6.4	6.3	5.8	5.3
9.0	7.9	6.7	6.5	6.3	5.8	5.3	
11.0	9.8	6.9	6.6	6.3	5.8	5.3	
13.0	11.8	7.1	6.7	6.3	5.8	5.3	
15.0	13.7	7.3	6.8	6.3	5.8	5.3	

2 Capacity table

AR5000

Heating

TC : Total Capacity

Capacity Index	Outdoor Air Temp. (°C)		Indoor temperature (°C,DB)				
			16(°C,DB)	18(°C,DB)	20(°C,DB)	22(°C,DB)	24(°C,DB)
	DB	WB	TC kW	TC kW	TC kW	TC kW	TC kW
071	-19.8	-20.0	5.0	4.9	4.8	4.8	4.8
	-18.8	-19.0	5.1	5.0	4.8	4.8	4.8
	-16.7	-17.0	5.2	5.1	4.9	4.9	4.8
	-14.7	-15.0	5.4	5.3	5.1	4.9	4.8
	-12.6	-13.0	5.6	5.4	5.3	5.2	5.1
	-10.5	-11.0	5.8	5.7	5.6	5.5	5.5
	-9.5	-10.0	5.9	5.9	5.8	5.7	5.6
	-8.5	-9.1	6.0	6.0	5.9	5.8	5.7
	-7.0	-7.6	6.2	6.2	6.1	5.9	5.8
	-5.0	-5.6	6.5	6.4	6.4	6.2	5.9
	-3.0	-3.7	6.9	6.7	6.7	6.4	6.2
	0.0	-0.7	7.2	7.1	7.0	6.7	6.4
	3.0	2.2	7.5	7.4	7.3	7.1	6.7
	5.0	4.1	7.9	7.8	7.7	7.2	6.7
	7.0	6.0	8.2	8.1	8.0	7.4	6.7
9.0	7.9	8.5	8.2	8.0	7.4	6.7	
11.0	9.8	8.7	8.3	8.0	7.4	6.7	
13.0	11.8	9.0	8.5	8.0	7.4	6.7	
15.0	13.7	9.3	8.6	8.0	7.4	6.7	
082	-19.8	-20.0	5.3	5.1	5.1	5.0	5.0
	-18.8	-19.0	5.3	5.2	5.2	5.0	5.0
	-16.7	-17.0	5.4	5.4	5.3	5.1	5.1
	-14.7	-15.0	5.7	5.5	5.4	5.3	5.1
	-12.6	-13.0	5.9	5.7	5.6	5.6	5.4
	-10.5	-11.0	6.1	6.1	6.0	5.9	5.8
	-9.5	-10.0	6.3	6.3	6.2	6.0	5.9
	-8.5	-9.1	6.4	6.4	6.3	6.1	6.0
	-7.0	-7.6	6.6	6.5	6.5	6.3	6.1
	-5.0	-5.6	7.0	6.9	6.7	6.6	6.3
	-3.0	-3.7	7.3	7.2	7.2	6.9	6.6
	0.0	-0.7	7.7	7.6	7.4	7.2	6.7
	3.0	2.2	8.0	8.0	7.8	7.6	7.2
	5.0	4.1	8.4	8.2	8.1	7.7	7.2
	7.0	6.0	8.8	8.6	8.5	7.8	7.2
9.0	7.9	9.0	8.8	8.5	7.8	7.2	
11.0	9.8	9.3	8.9	8.5	7.8	7.2	
13.0	11.8	9.6	9.0	8.5	7.8	7.2	
15.0	13.7	9.8	9.2	8.5	7.8	7.2	

3 Dimensional drawing

AR5000

AM015/022/028JN*DKH***

Units : mm / inches

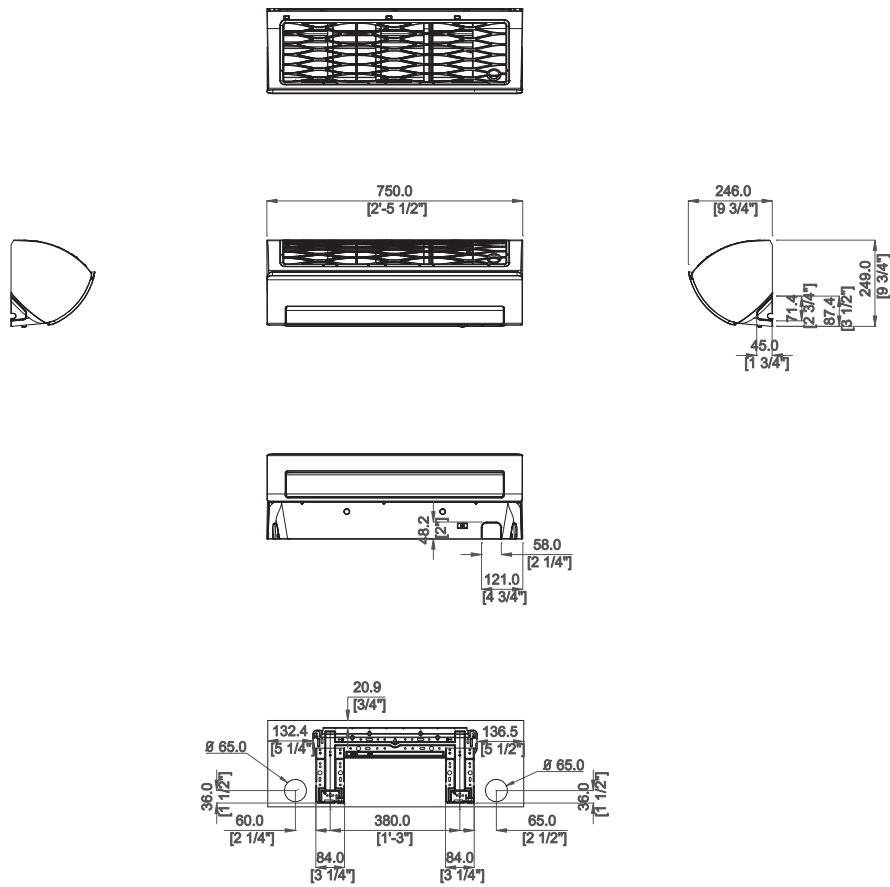

No.	Name	Description		
		1.5kW	2.2kW	2.8kW
1	Refrigerant gas pipe	Ø12.7 Flare		
2	Refrigerant liquid pipe	Ø6.35 Flare		
3	Drain pipe connection	ID 18 Hose		

3 Dimensional drawing

AR5000

AM036/045JN*DKH***

Units : mm / inches

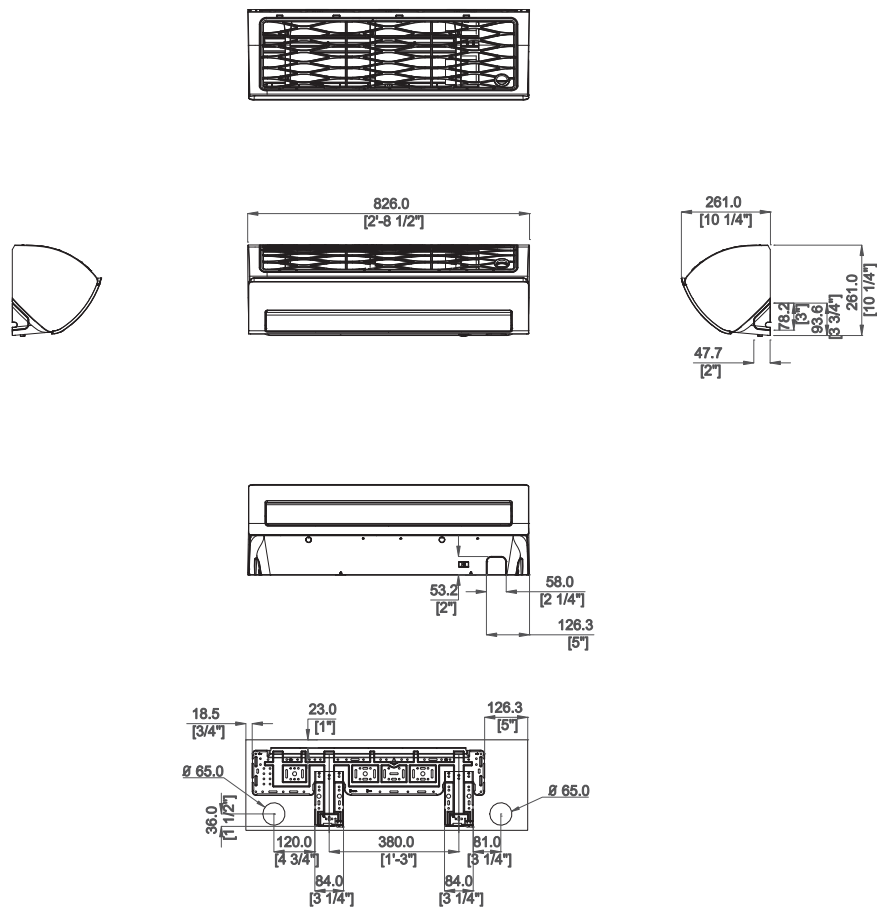

No.	Name	Description	
		3.6kW	4.5kW
1	Refrigerant gas pipe	Ø12.7 Flare	
2	Refrigerant liquid pipe	Ø6.35 Flare	
3	Drain pipe connection	ID 18 Hose	

3 Dimensional drawing

AR5000

AM056/071/082JN*DKH***

Units : mm / inches

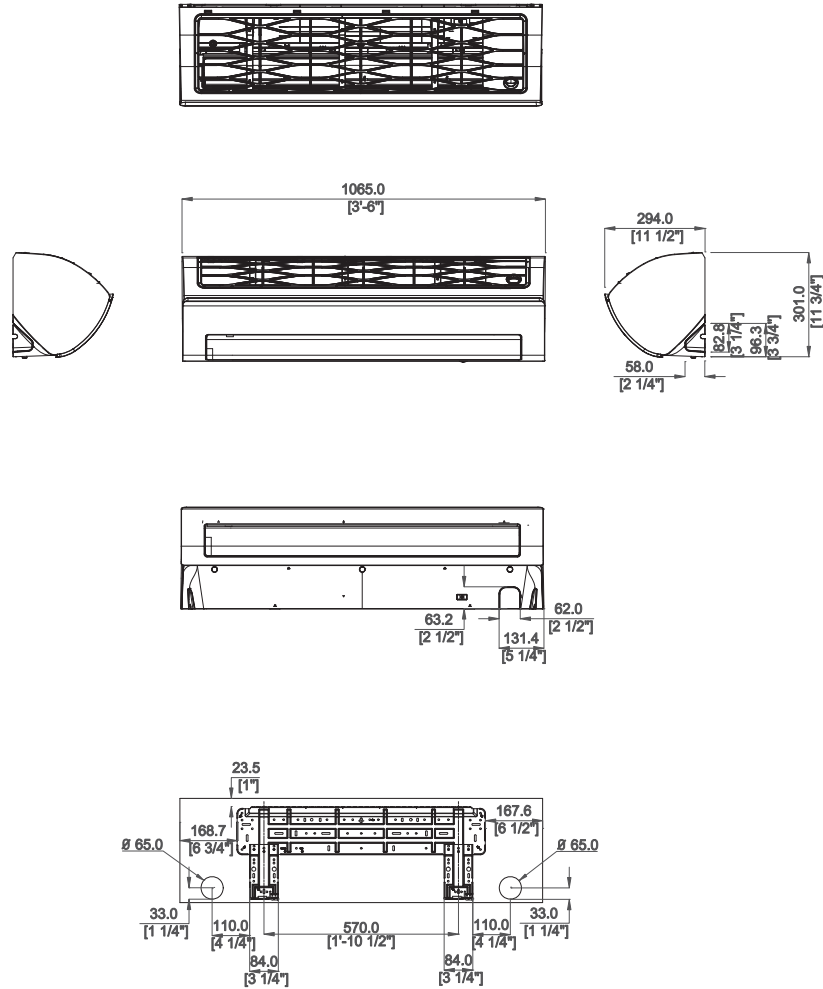

No.	Name	Description		
		5.6kW	7.1kW	8.2kW
1	Refrigerant gas pipe	$\varnothing 12.7$ Flare	$\varnothing 15.88$ Flare	
2	Refrigerant liquid pipe	$\varnothing 6.35$ Flare	$\varnothing 9.52$ Flare	
3	Drain pipe connection	ID 18 Hose		

4 Electrical Wiring Diagram

AR5000

AM015/022/028/036/045/056/071/082JNADKH/EU, AM015/022/028/036/045/056/071/082JNVDKH/EU

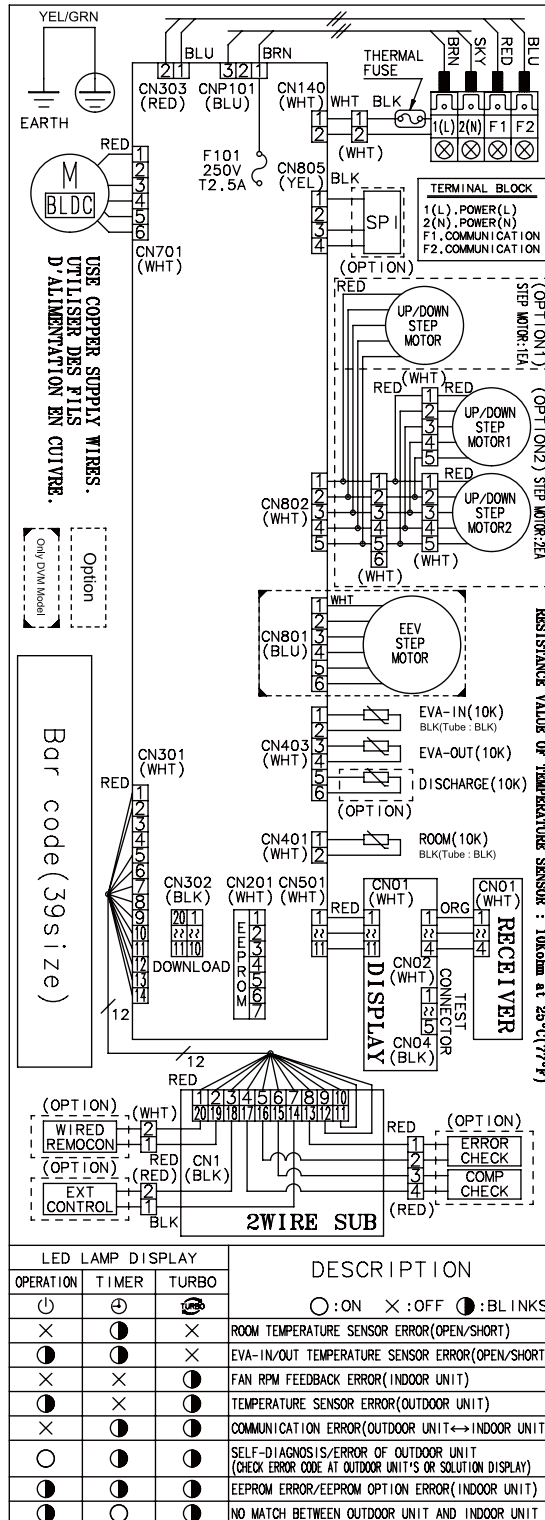

NOTE

1. This wiring diagram applies only to the indoor unit.
2. Symbols show as follow;
BLK : black, RED : red, BLU : blue, WHT: white, YEL : yellow, BRN : brown, SKY : sky-blue, GRN : green
3. For connection wiring indoor-outdoor transmission F1-F2, indoor-wired remotecontroller transmission F3-F4.
4. : Protective earth(screw), : Connector, _n : The wire quantity

5 Sound pressure level

AR5000

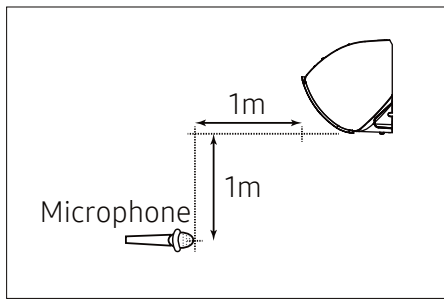

Unit: dB(A)

Model	High	Low
AM015JNVDKH/EU	28	24
AM022JNVDKH/EU	33	25
AM028JNVDKH/EU	36	25
AM036JNVDKH/EU	37	30

Note

Specifications may be subject to change without prior notice.
 Sound pressure level is obtained in an anechoic room.
 Sound pressure level is a relative value, depending on the distance and acoustic environment.
 Sound pressure level may differ depending on operation condition.
 dBA = A-weighted sound pressure level
 Reference acoustic pressure 0 dB= 20 uPa

NR curve

1) AM015JNVDKH/EU

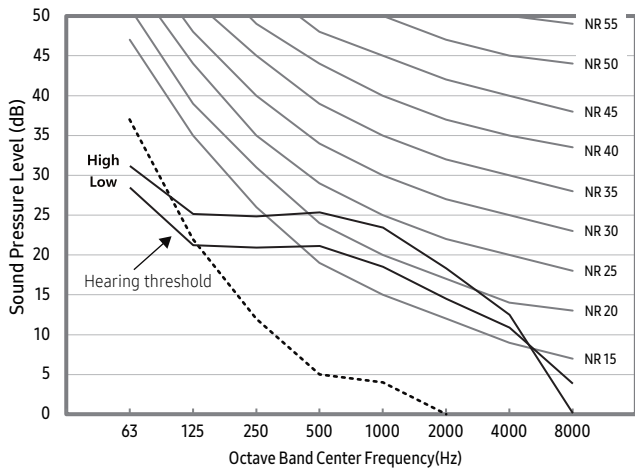

2) AM022JNVDKH/EU

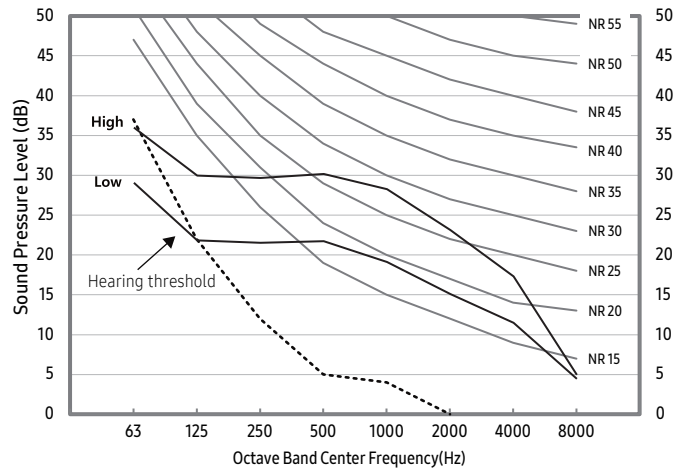

3) AM028JNVDKH/EU

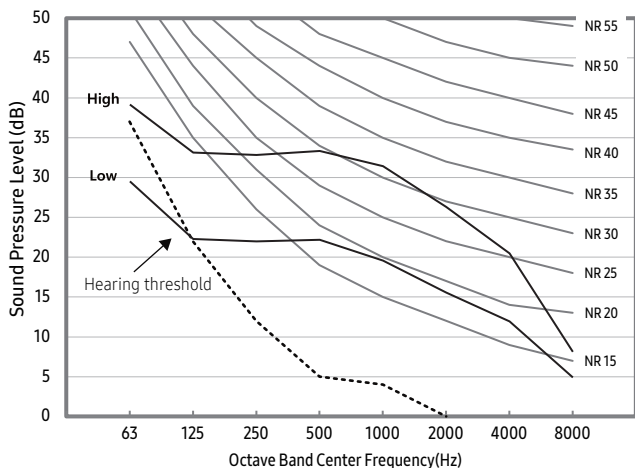

4) AM036JNVDKH/EU

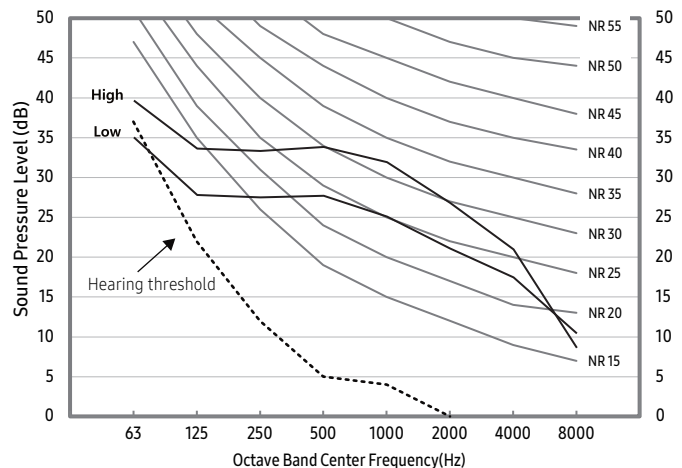

5 Sound pressure level

AR5000

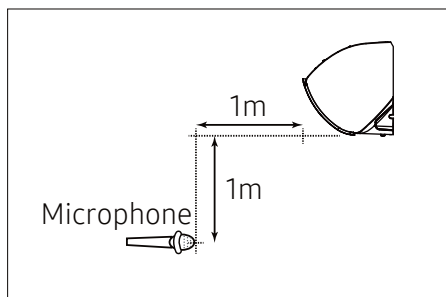

Unit: dB(A)

Model	High	Low
AM045JNVDKH/EU	41	34
AM056JNVDKH/EU	39	33
AM071JNVDKH/EU	44	36
AM082JNVDKH/EU	47	40

Note

Specifications may be subject to change without prior notice.
 Sound pressure level is obtained in an anechoic room.
 Sound pressure level is a relative value, depending on the distance and acoustic environment.
 Sound pressure level may differ depending on operation condition.
 dBA = A-weighted sound pressure level
 Reference acoustic pressure 0 dB= 20 uPa

NR curve

1) AM045JNVDKH/EU

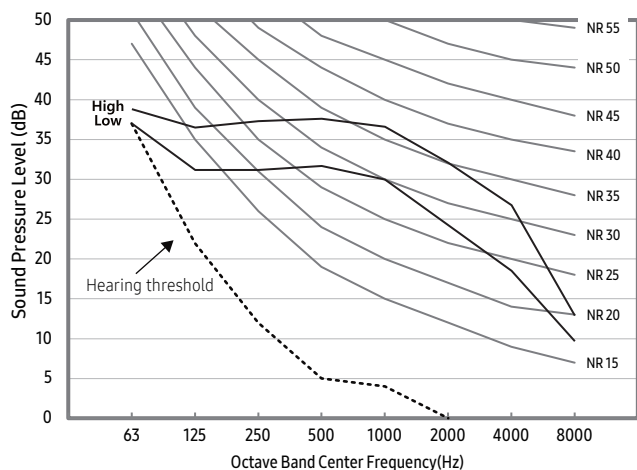

2) AM056JNVDKH/EU

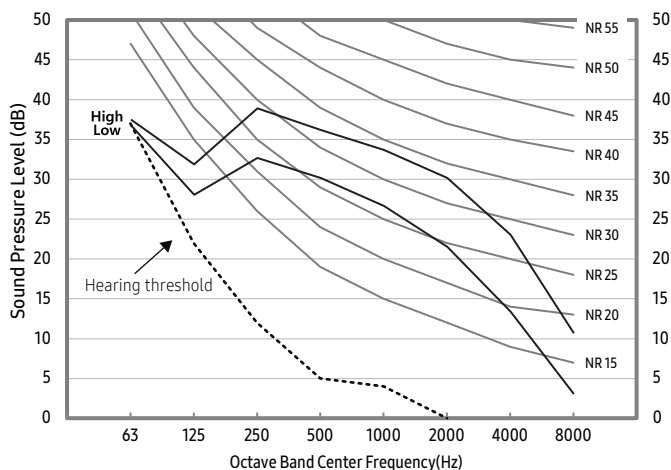

3) AM071JNVDKH/EU

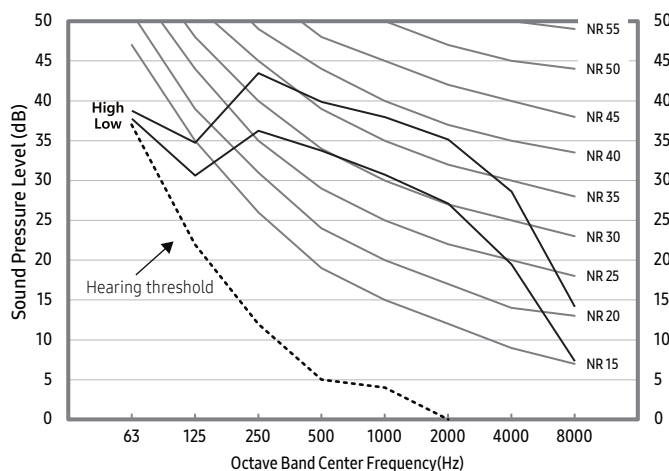

4) AM082JNVDKH/EU

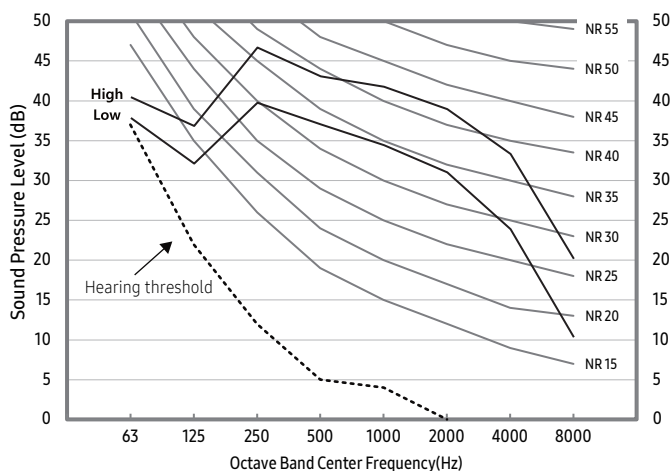

5 Sound pressure level

AR5000

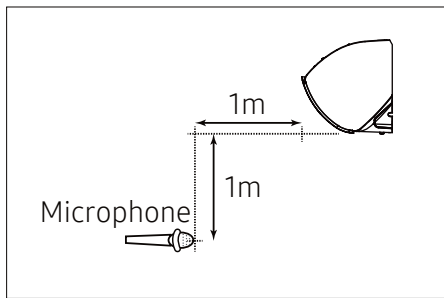

Unit: dB(A)

Model	High	Low
AM015JNADKH/EU	26	21
AM022JNADKH/EU	33	23
AM028JNADKH/EU	35	25
AM036JNADKH/EU	36	29

Note

Specifications may be subject to change without prior notice.
 Sound pressure level is obtained in an anechoic room.
 Sound pressure level is a relative value, depending on the distance and acoustic environment.
 Sound pressure level may differ depending on operation condition.
 dBA = A-weighted sound pressure level
 Reference acoustic pressure 0 dB= 20 uPa

NR curve

1) AM015JNADKH/EU

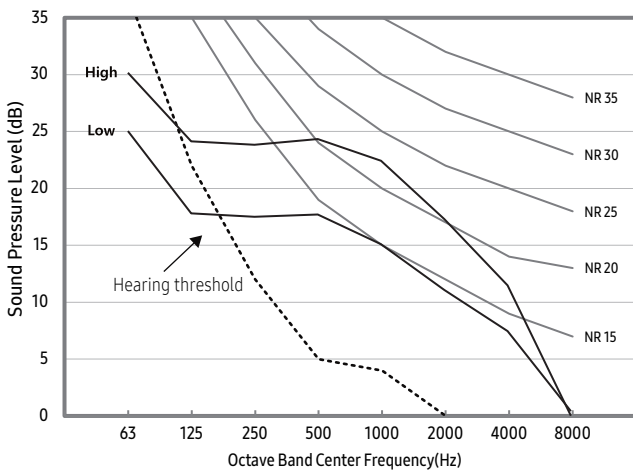

2) AM022JNADKH/EU

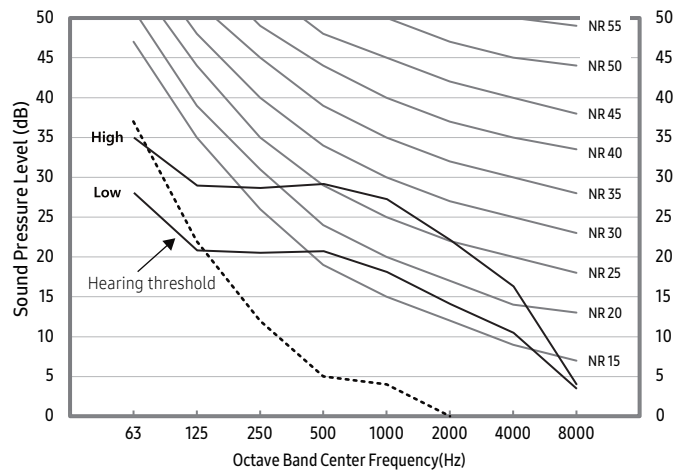

3) AM028JNADKH/EU

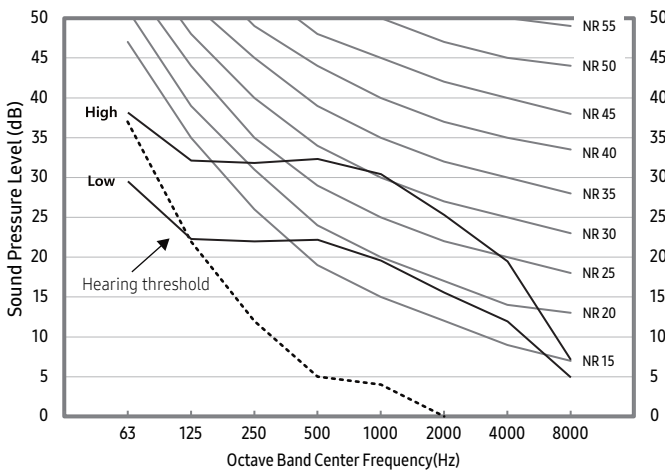

4) AM036JNADKH/EU

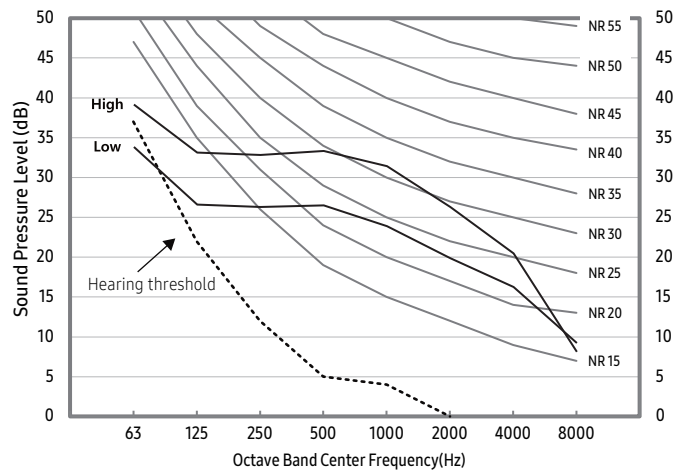

5 Sound pressure level

AR5000

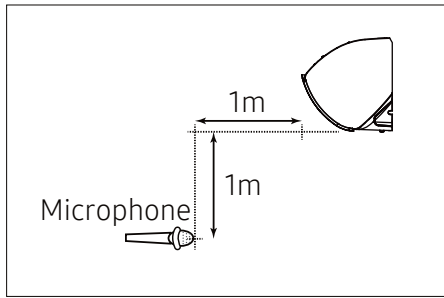

Unit: dB(A)

Model	High	Low
AM045JNADKH/EU	40	33
AM056JNADKH/EU	39	32
AM071JNADKH/EU	44	36
AM082JNADKH/EU	47	40

Note

Specifications may be subject to change without prior notice.
 Sound pressure level is obtained in an anechoic room.
 Sound pressure level is a relative value, depending on the distance and acoustic environment.
 Sound pressure level may differ depending on operation condition.
 dBA = A-weighted sound pressure level
 Reference acoustic pressure 0 dB= 20 uPa

NR curve

1) AM045JNADKH/EU

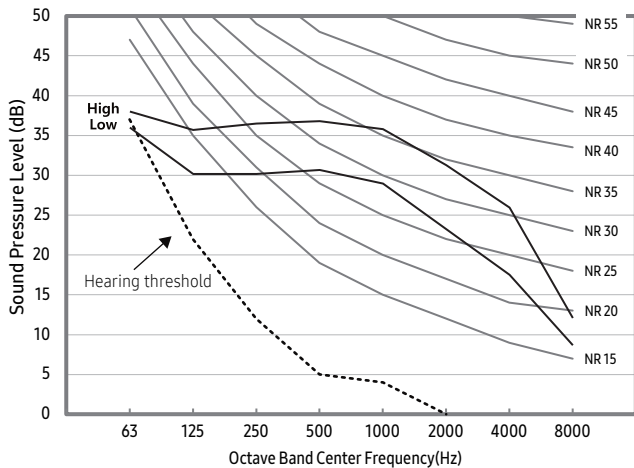

2) AM056JNADKH/EU

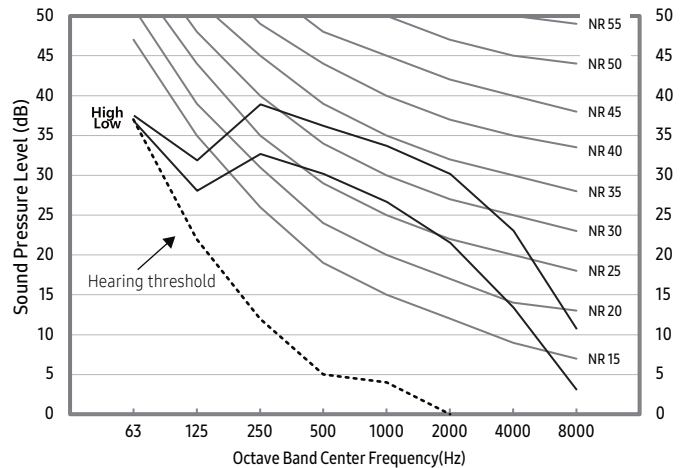

3) AM071JNADKH/EU

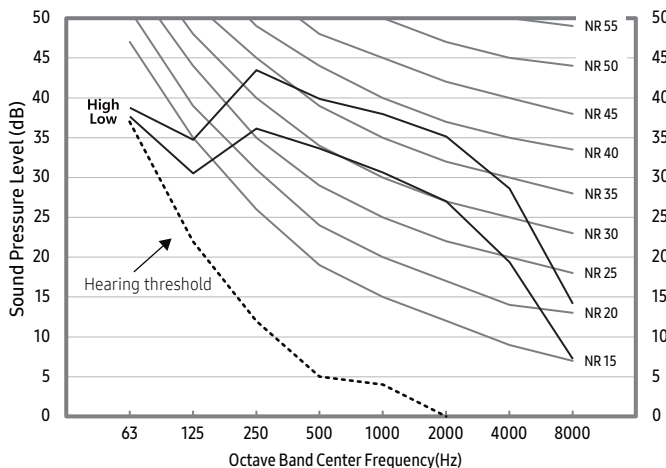

4) AM082JNADKH/EU

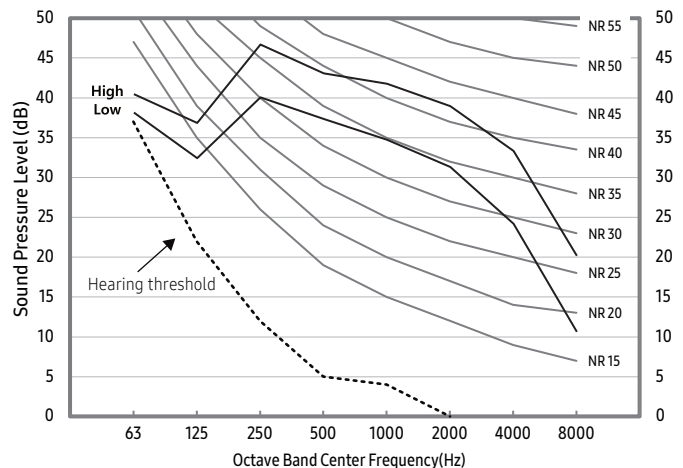

6 Sound power level

AR5000

Note

- . Specifications may be subject to change without prior notice.
- . Sound power level is an absolute value that a sound source generates.
- . dBA = A-weighted sound power level.
- . Reference power : 1pW.
- . Measured according to ISO 3741

Unit: dB(A)

Model	Power
AM015JN*DKH/EU	44
AM022JN*DKH/EU	50
AM028JN*DKH/EU	53
AM036JN*DKH/EU	54

1)AM015JN*DKH/EU

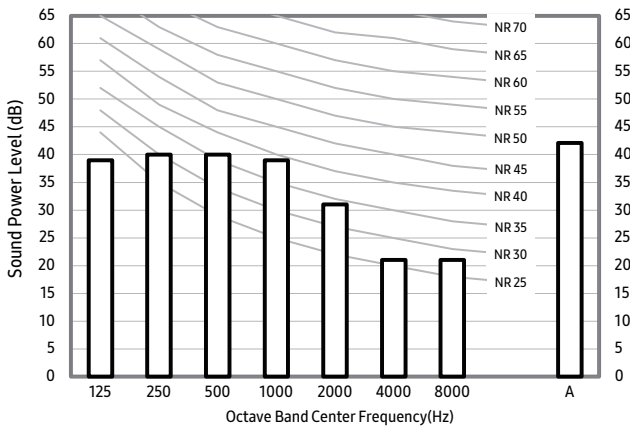

2)AM022JN*DKH/EU

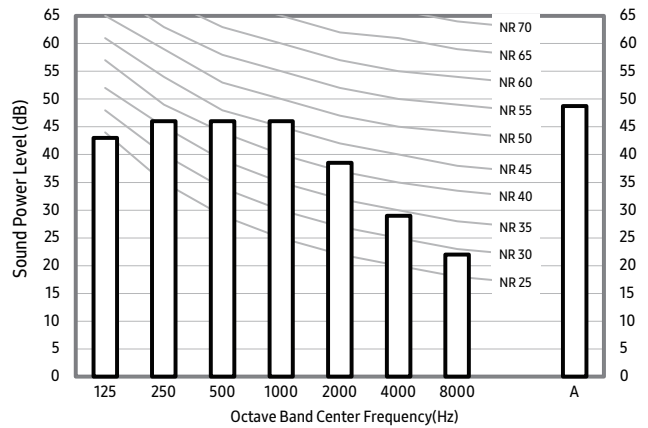

3)AM028JN*DKH/EU

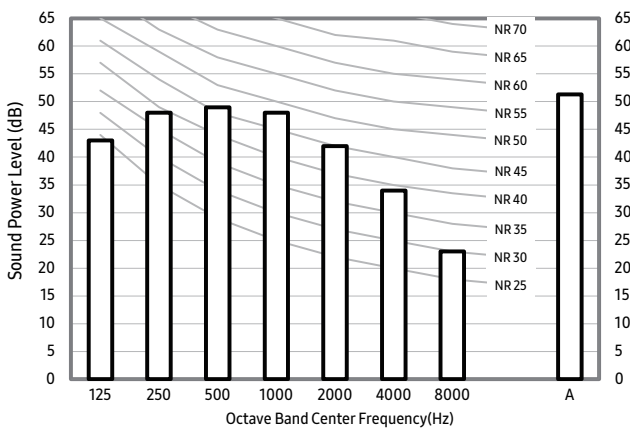

4)AM036JN*DKH/EU

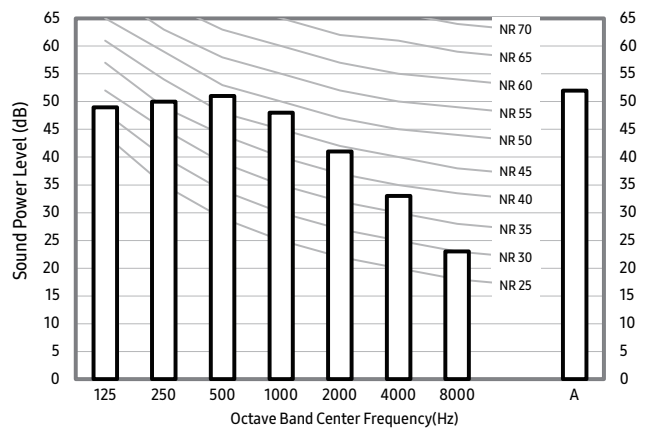

6 Sound power level

AR5000

Note

- . Specifications may be subject to change without prior notice.
- . Sound power level is an absolute value that a sound source generates.
- . dBA = A-weighted sound power level.
- . Reference power : 1pW.
- . Measured according to ISO 3741

Unit: dB(A)

Model	Power
AM045JN*DKH/EU	57
AM056JN*DKH/EU	57
AM071JN*DKH/EU	61
AM082JN*DKH/EU	65

1)AM045JN*DKH/EU

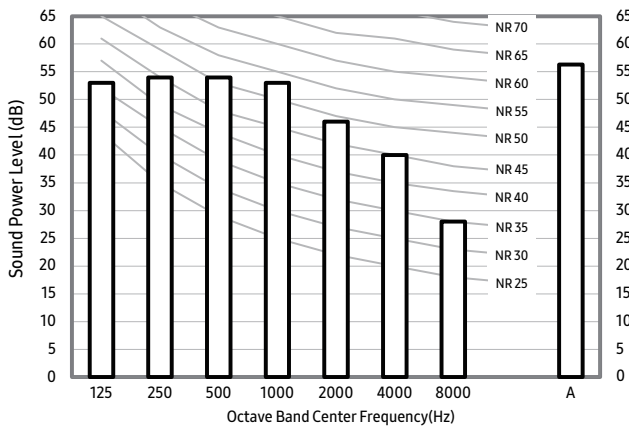

2)AM056JN*DKH/EU

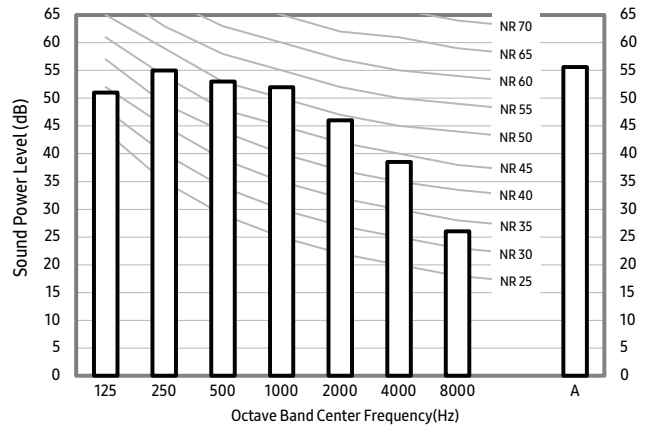

3)AM071JN*DKH/EU

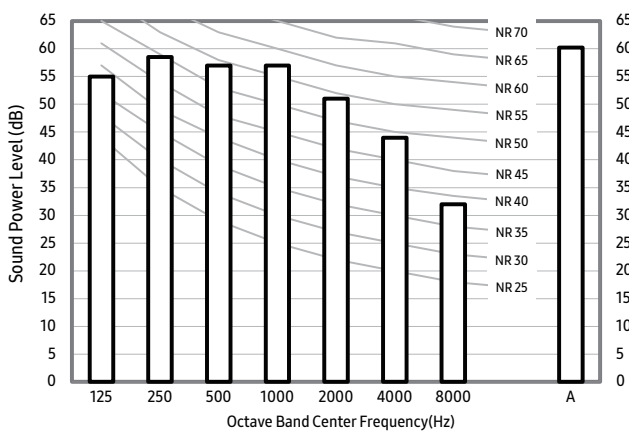

4)AM082JN*DKH/EU

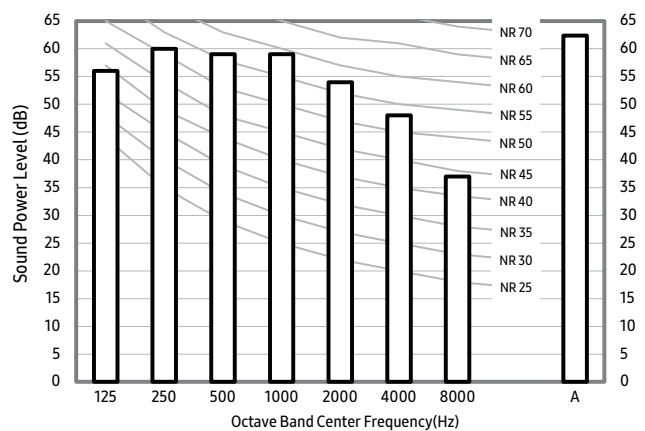

7 Temperature and air flow distribution

AR5000

AM015/022/028JNADKH/EU, AM015/022/028JNVDKH/EU

(1) Cooling air velocity distribution

Discharge angle : 25°

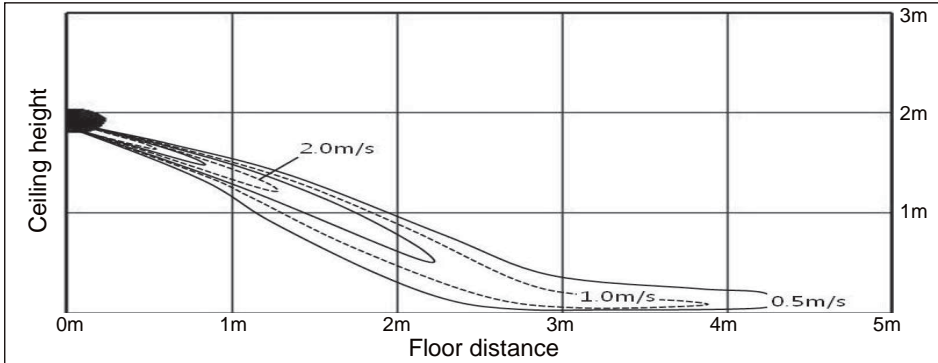

(2) Cooling temperature distribution

Discharge angle : 25°

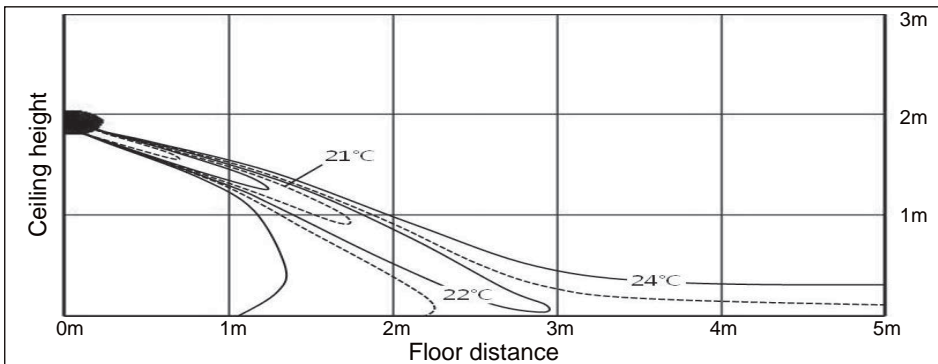

(3) Heating air velocity distribution

Discharge angle : 55°

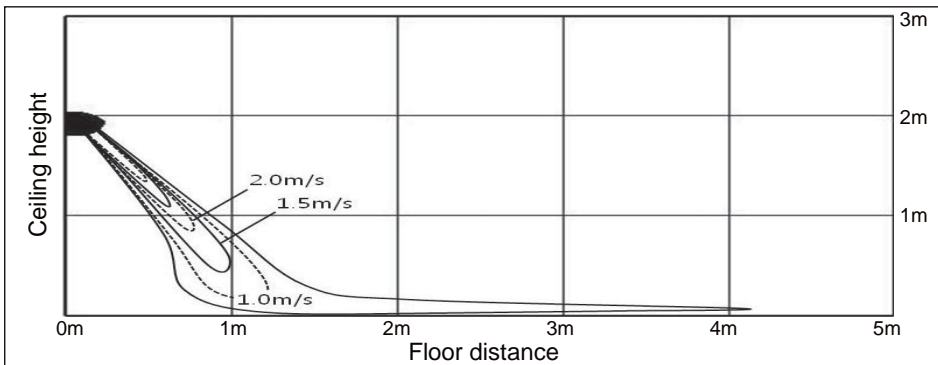

(4) Heating temperature distribution

Discharge angle : 55°

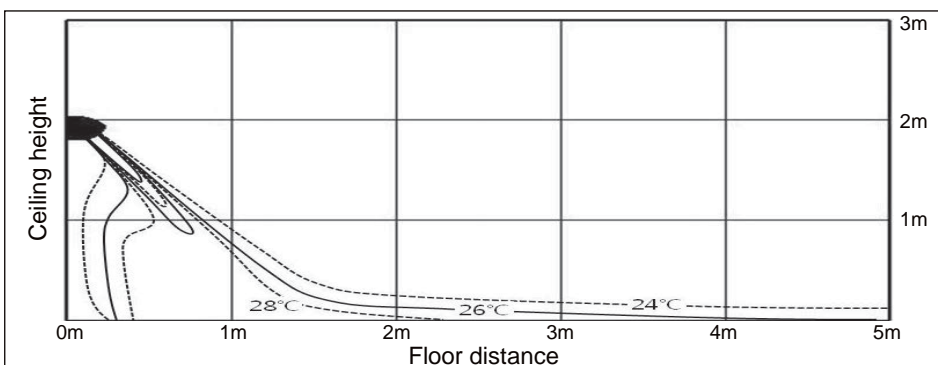

7 Temperature and air flow distribution

AR5000

AM036/045JNADKH/EU, AM036/045JNVDKH/EU

(1) Cooling air velocity distribution

Discharge angle : 18°

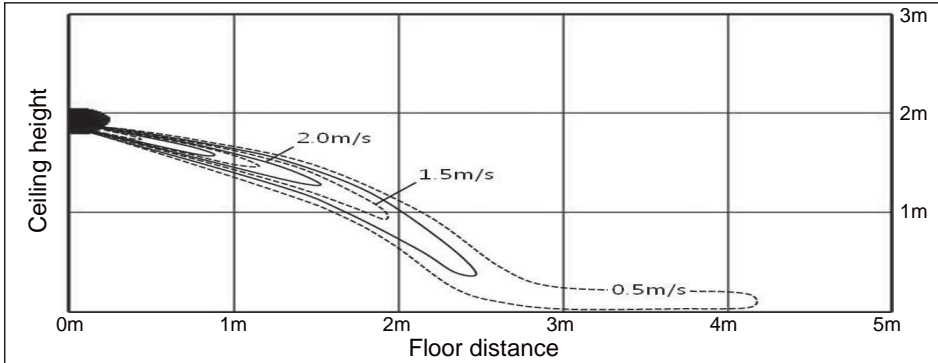

(2) Cooling temperature distribution

Discharge angle : 18°

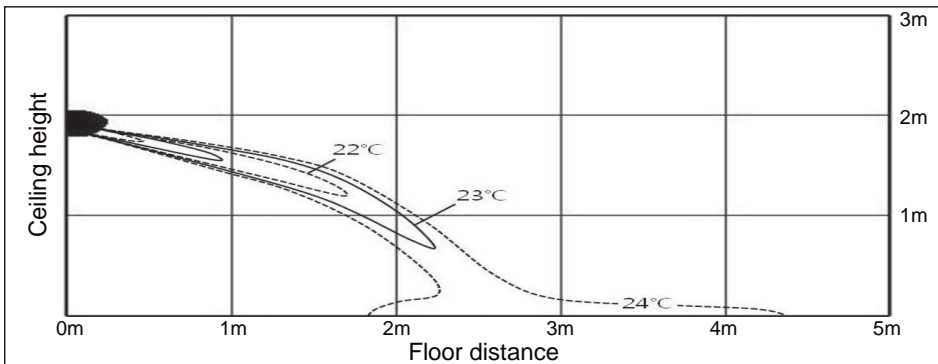

(3) Heating air velocity distribution

Discharge angle : 46°

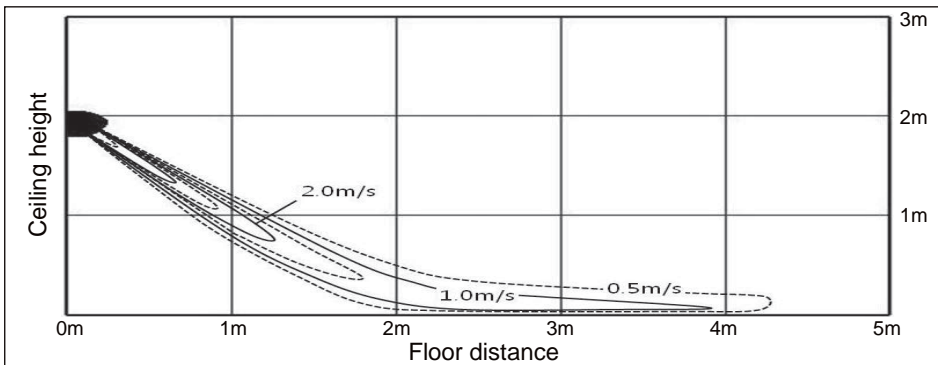

(4) Heating temperature distribution

Discharge angle : 46°

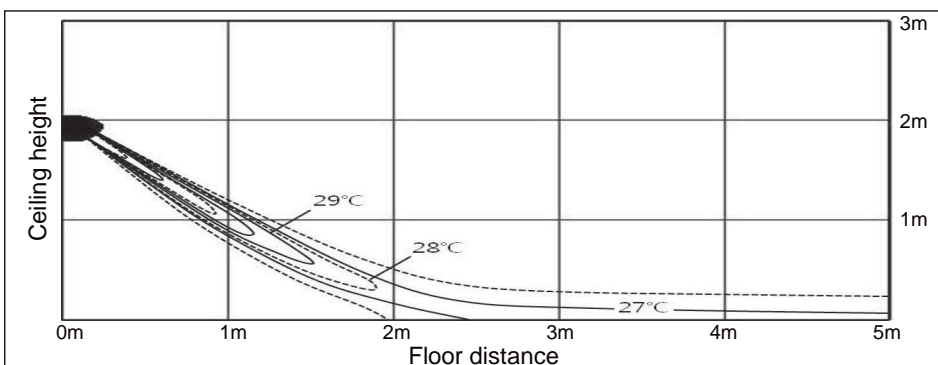

7 Temperature and air flow distribution

AR5000

AM056JNADKH/EU, AM056JNVDKH/EU

(1) Cooling air velocity distribution

Discharge angle : 18°

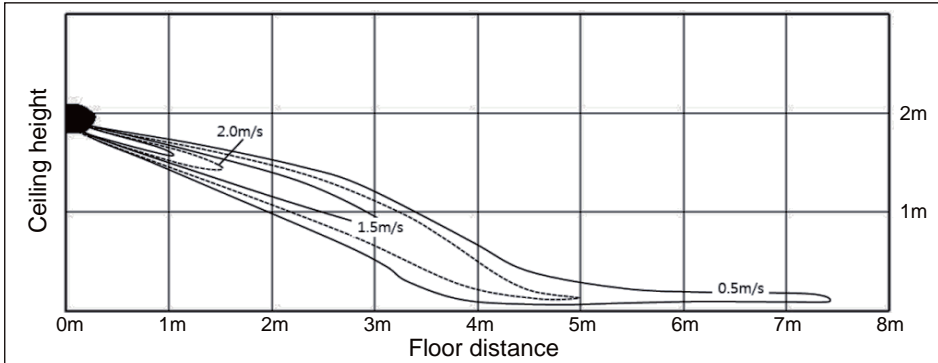

(2) Cooling temperature distribution

Discharge angle : 18°

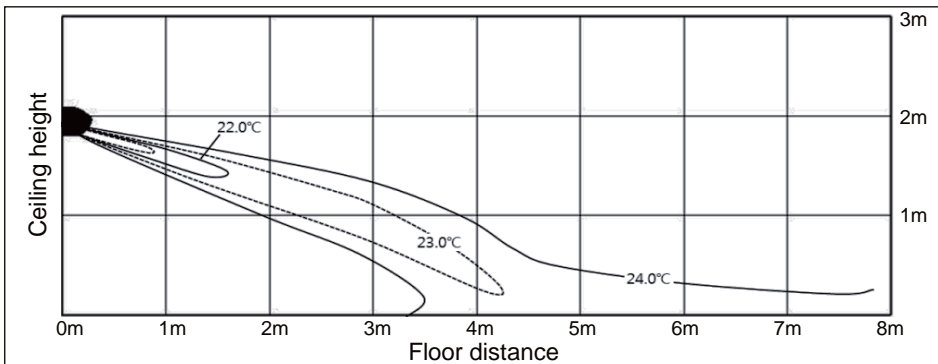

(3) Heating air velocity distribution

Discharge angle : 46°

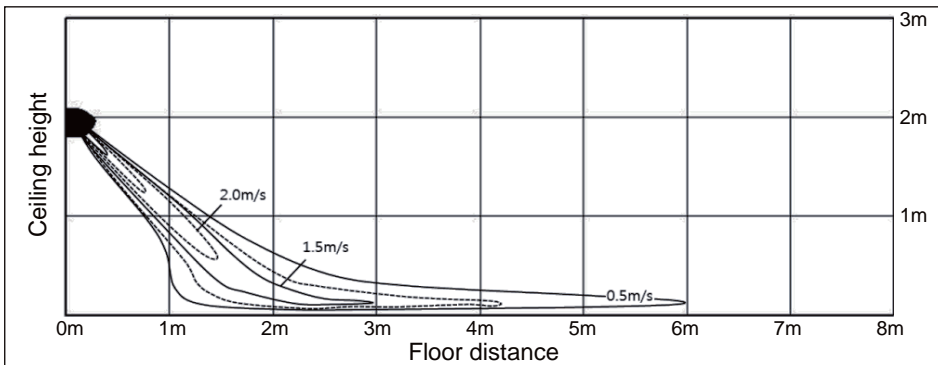

(4) Heating temperature distribution

Discharge angle : 46°

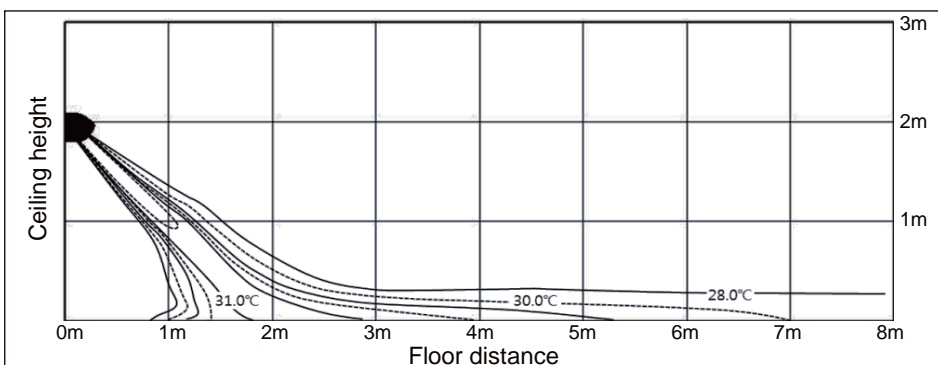

7 Temperature and air flow distribution

AR5000

AM071JNADKH/EU, AM071JNVDKH/EU

(1) Cooling air velocity distribution

Discharge angle : 18°

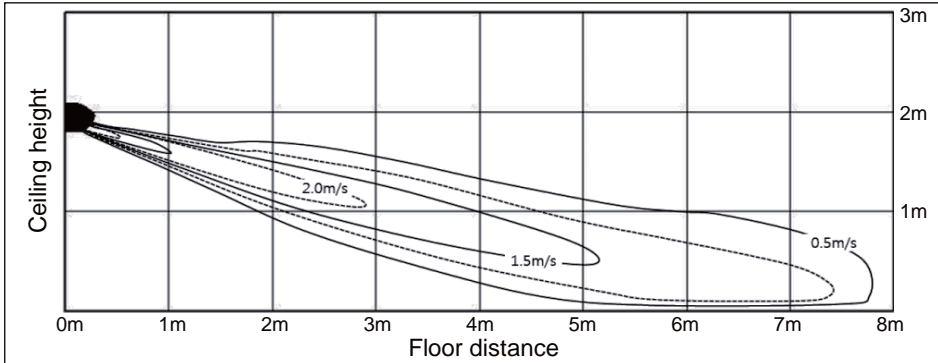

(2) Cooling temperature distribution

Discharge angle : 18°

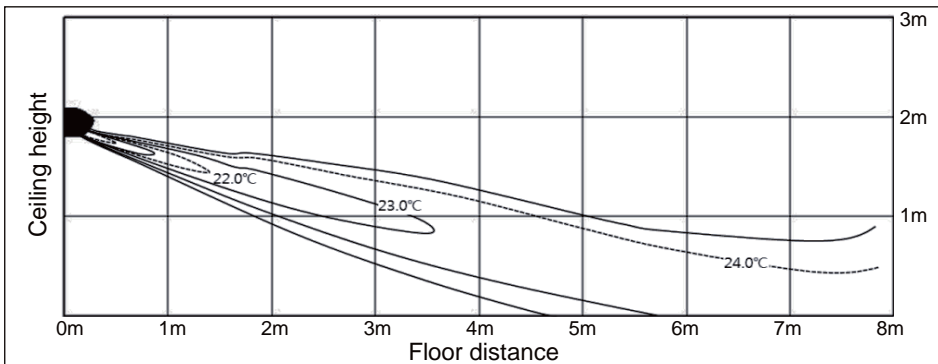

(3) Heating air velocity distribution

Discharge angle : 46°

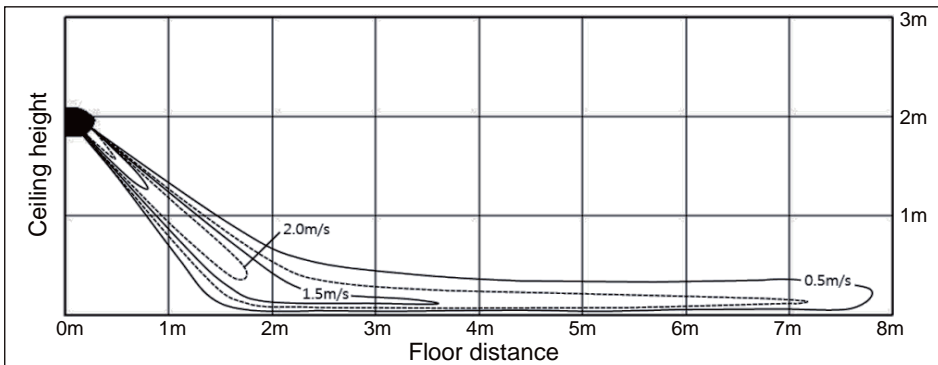

(4) Heating temperature distribution

Discharge angle : 46°

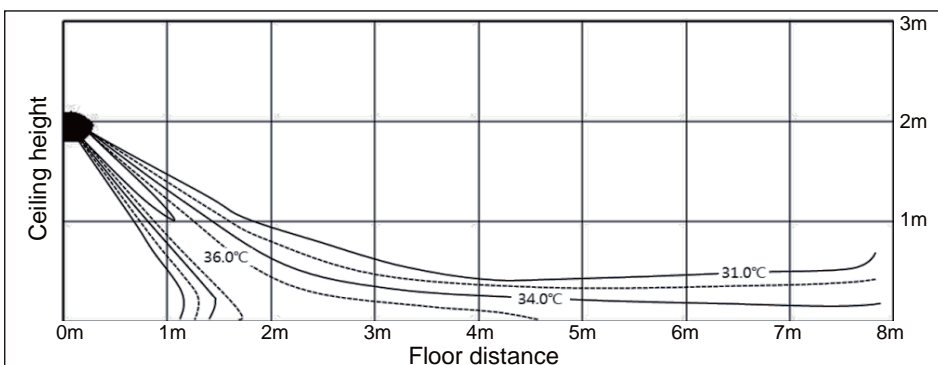

7 Temperature and air flow distribution

AR5000

AM082JNADKH/EU, AM082JNVDKH/EU

(1) Cooling air velocity distribution

Discharge angle : 32°

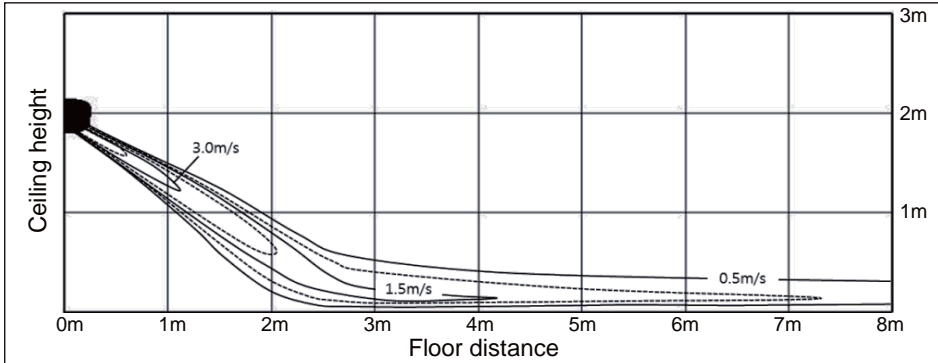

(2) Cooling temperature distribution

Discharge angle : 32°

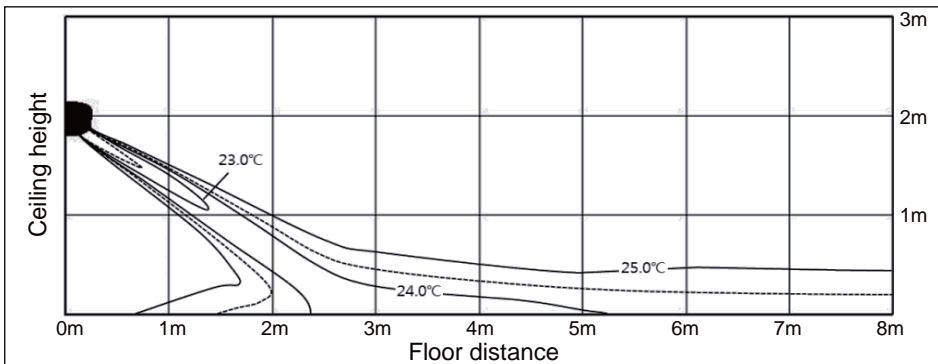

(3) Heating air velocity distribution

Discharge angle : 32°

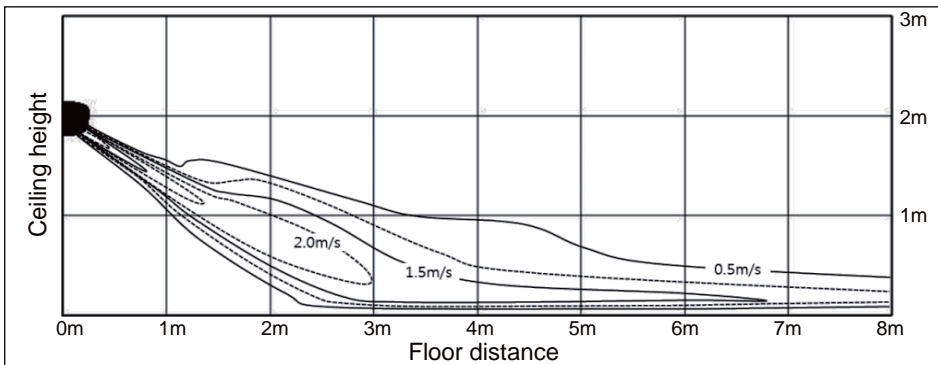

(4) Heating temperature distribution

Discharge angle : 32°

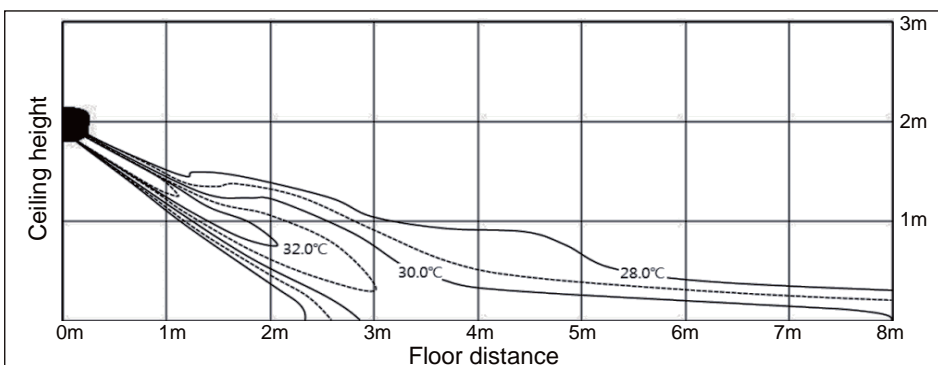

BORACAY

- 1 *Specifications*
- 2 *Summary Table*
- 3 *Capacity Table*
- 4 *Dimensional Drawing*
- 5 *Center of Gravity*
- 6 *Electrical Wiring Diagram*
- 7 *Sound data*
- 8 *Temperature and Air Flow Distribution*
- 9 *Piping Diagram*

1. Specification

BORACAY

Type			WALL MOUNTED	WALL MOUNTED	WALL MOUNTED	WALL MOUNTED	
Model CODE			AM015KNTDEH/EU	AM022KNTDEH/EU	AM028KNTDEH/EU	AM036KNTDEH/EU	
Power Supply		Ø, #, V, Hz	1, 2, 220-240, 50	1, 2, 220-240, 50	1, 2, 220-240, 50	1,2,220-240,50	
Mode			HEAT PUMP	HEAT PUMP	HEAT PUMP	HEAT PUMP	
Performance	Capacity (Nominal)	Cooling	kW	1.5	2.2	2.8	3.6
			Btu/h	5,100	7,500	9,600	12,300
		Heating	kW	1.7	2.5	3.2	4.0
			Btu/h	5,800	8,500	10,900	13,600
Power	Power Input (Nominal)	Cooling	W	32.0	32.0	38.0	42.0
		Heating		34.0	35.0	39.0	42.0
	Current Input (Nominal)	Cooling	A	0.20	0.20	0.22	0.23
		Heating		0.20	0.20	0.22	0.23
	MCA			0.3	0.3	0.4	0.4
	MFA			15.0	15.0	15.0	15.0
Type		-		Fin & Tube	Fin & Tube	Fin & Tube	Fin & Tube
Heat exchanger	Material	Fin		-	Al	Al	Al
		Tube	-	Cu	Cu	Cu	Cu
	Fin Treatment		-	Anti-corrosion	Anti-corrosion	Anti-corrosion	Anti-corrosion
Fan	Type		-	Crossflow Fan	Crossflow Fan	Crossflow Fan	Crossflow Fan
	Quantity		ea	1	1	1	1
	Air Flow Rate	H/M/L (UL)	CMM	6.2/5.7/5.1	6.6/5.7/5.1	7.0/6.2/5.5	8.5/7.5/6.6
			l/s	103.3/95.0/85.0	110.0/95.0/85.0	116.7/103.3/91.7	141.7/125.0/110.0
	External Pressure	Min/Std/Max	mmAq	-	-	-	-
			Pa	-	-	-	-
Fan motor	Type		-	SSR Feedback	SSR Feedback	SSR Feedback	SSR Feedback
	Output x n		-	19W x 1	19W x 1	19W x 1	19W x 1
Piping Connections	Liquid Pipe		Type	Flare connection	Flare connection	Flare connection	Flare connection
			Ø, mm	6.35	6.35	6.35	6.35
			Ø, inch	1/4"	1/4"	1/4"	1/4"
	Gas Pipe		Type	Flare connection	Flare connection	Flare connection	Flare connection
			Ø, mm	12.7	12.7	12.7	12.7
			Ø, inch	1/2"	1/2"	1/2"	1/2"
	Drain Pipe		Ø, mm	ID 18 HOSE	ID 18 HOSE	ID 18 HOSE	ID 18 HOSE
Heat insulation		-	Both liquid and gas pipes	Both liquid and gas pipes	Both liquid and gas pipes	Both liquid and gas pipes	
Field Wiring	Power Source Wire	Minimum	mm2	1.5	1.5	1.5	1.5
	For connection with indoor	Minimum	mm2	0.75	0.75	0.75	0.75
		Remark	-	F1, F2	F1, F2	F1, F2	F1, F2
Refrigerant	Type		-	R410A	R410A	R410A	R410A
	Control Method		-	EEV NOT INCLUDED	EEV NOT INCLUDED	EEV NOT INCLUDED	EEV NOT INCLUDED
Sound	Sound Pressure	High/Mid/Low	dB(A)	30/28/25	31/28/25	31/29/26	36/33/29
	Sound Power	Cooling		47	48	48	51
Dimensions	Net Weight		kg	8.0	8.0	8.5	8.5
	Shipping Weight		kg	9.7	9.7	10.2	10.2
	Net Dimensions (W×H×D)		mm	820 x 285 x 227	820 x 285 x 227	820 x 285 x 227	820 x 285 x 227
	Shipping Dimensions (W×H×D)		mm	880 x 280 x 363	880 x 280 x 363	880 x 280 x 363	880 x 280 x 363

NOTE

- Mode : HP(Heat Pump), HR(Heat Recovery)
- Nominal Cooling : Indoor temperature 27°CDB / 19°CWB, Outdoor temperature 35°CDB / 24°CWB, Refrigerant pipe length 7.5m, Level difference 0m.
- Nominal Heating : Indoor temperature 20°CDB / 15°CWB, Outdoor temperature 7°CDB / 6°CWB, Refrigerant pipe length 7.5m, Level difference 0m.
- Sound level was acquired in an anechoic room. Thus actual noise level may be different depending on the installation conditions.
- These products contain R410A which is fluorinated greenhouse gas.
- Specifications may be subject to change without prior notice.
- Select wire size based on the value of MCA

1. Specification

BORACAY

Type				WALL MOUNTED	WALL MOUNTED	WALL MOUNTED	
Model CODE				AM045KNTDEH/EU	AM056KNTDEH/EU	AM071KNTDEH/EU	
Power Supply			Ø, #, V, Hz	1,2,220-240,50	1,2,220-240,50	1,2,220-240,50	
Mode				HEAT PUMP	HEAT PUMP	HEAT PUMP	
Performance	Capacity (Nominal)	Cooling	kW	4.5	5.6	6.8	
			Btu/h	15,400	19,100	23,200	
		Heating	kW	5.0	6.3	7.0	
			Btu/h	17,100	21,500	23,900	
Power	Power Input (Nominal)	Cooling	W	47.0	48.0	51.0	
		Heating		47.0	48.0	53.0	
	Current Input (Nominal)	Cooling	A	0.27	0.27	0.28	
		Heating		0.27	0.27	0.28	
	MCA			0.4	0.4	0.4	
	MFA			15.0	15.0	15.0	
Heat exchanger				Type	Fin & Tube	Fin & Tube	Fin & Tube
	Material	Fin		-	Al	Al	Al
		Tube	-	Cu	Cu	Cu	
Fin Treatment			-	Anti-corrosion	Anti-corrosion	Anti-corrosion	
Fan	Type		-	Crossflow Fan	Crossflow Fan	Crossflow Fan	
	Quantity		ea	1	1	1	
	Air Flow Rate	H/M/L (UL)	CMM	13.9/12.4/11.2	14.4/12.9/11.2	15.7/14.1/12.9	
			l/s	231.7/206.7/186.7	240.0/215.0/186.7	261.7/235.0/215.0	
	External Pressure	Min/Std/Max	mmAq	-	-	-	
			Pa	-	-	-	
Fan motor	Type		-	SSR Feedback	SSR Feedback	SSR Feedback	
	Output x n		-	28W x 1	28W x 1	28W x 1	
Piping Connections	Liquid Pipe		Type	Flare connection	Flare connection	Flare connection	
			Ø, mm	6.35	6.35	9.52	
			Ø, inch	1/4"	1/4"	3/8"	
	Gas Pipe		Type	Flare connection	Flare connection	Flare connection	
			Ø, mm	12.7	12.7	15.88	
			Ø, inch	1/2"	1/2"	5/8"	
Drain Pipe		Ø, mm	ID 18 HOSE	ID 18 HOSE	ID 18 HOSE		
Heat insulation			-	Both liquid and gas pipes	Both liquid and gas pipes	Both liquid and gas pipes	
Field Wiring	Power Source Wire	Minimum	mm2	1.5	1.5	1.5	
		For connection with indoor	Minimum	mm2	0.75	0.75	0.75
			Remark	-	F1, F2	F1, F2	F1, F2
Refrigerant	Type		-	R410A	R410A	R410A	
	Control Method		-	EEV NOT INCLUDED	EEV NOT INCLUDED	EEV NOT INCLUDED	
Sound	Sound Pressure	High/Mid/Low	dB(A)	38/35/33	39/36/33	40/38/35	
	Sound Power	Cooling		53	53	55	
Dimensions	Net Weight		kg	12.0	12.0	12.0	
	Shipping Weight		kg	14.0	14.0	14.0	
	Net Dimensions (W×H×D)		mm	1065 x 298 x 243	1065 x 298 x 243	1065 x 298 x 243	
	Shipping Dimensions (W×H×D)		mm	1128 x 299 x 378	1128 x 299 x 378	1128 x 299 x 378	

NOTE

- Mode : HP(Heat Pump), HR(Heat Recovery)
- Nominal Cooling : Indoor temperature 27°CDB / 19°CWB, Outdoor temperature 35°CDB / 24°CWB, Refrigerant pipe length 7.5m, Level difference 0m.
- Nominal Heating : Indoor temperature 20°CDB / 15°CWB, Outdoor temperature 7°CDB / 6°CWB, Refrigerant pipe length 7.5m, Level difference 0m.
- Sound level was acquired in an anechoic room. Thus actual noise level may be different depending on the installation conditions.
- These products contain R410A which is fluorinated greenhouse gas.
- Specifications may be subject to change without prior notice.
- Select wire size based on the value of MCA

1. Specification

BORACAY

Type			WALL MOUNTED	WALL MOUNTED	WALL MOUNTED	WALL MOUNTED	
Model CODE			AM015KNQDEH/EU	AM022KNQDEH/EU	AM028KNQDEH/EU	AM036KNQDEH/EU	
Power Supply		Ø, #, V, Hz	1,2,220-240,50	1,2,220-240,50	1,2,220-240,50	1,2,220-240,50	
Mode			HEAT PUMP	HEAT PUMP	HEAT PUMP	HEAT PUMP	
Performance	Capacity (Nominal)	Cooling	kW	1.5	2.2	2.8	3.6
			Btu/h	5,100	7,500	9,600	12,300
		Heating	kW	1.7	2.5	3.2	4.0
			Btu/h	5,800	8,500	10,900	13,600
Power	Power Input (Nominal)	Cooling	W	32.0	32.0	38.0	42.0
		Heating		34.0	35.0	39.0	42.0
	Current Input (Nominal)	Cooling	A	0.20	0.20	0.22	0.23
		Heating		0.20	0.20	0.22	0.23
	MCA			0.3	0.3	0.4	0.4
	MFA			15.0	15.0	15.0	15.0
Heat exchanger	Type		-	Fin & Tube	Fin & Tube	Fin & Tube	Fin & Tube
	Material	Fin	-	Al	Al	Al	Al
		Tube	-	Cu	Cu	Cu	Cu
	Fin Treatment		-	Anti-corrosion	Anti-corrosion	Anti-corrosion	Anti-corrosion
Fan	Type		-	Crossflow Fan	Crossflow Fan	Crossflow Fan	Crossflow Fan
	Quantity		ea	1	1	1	1
	Air Flow Rate	H/M/L (UL)	CMM	6.2/5.7/5.1	6.6/5.7/5.1	7.0/6.2/5.5	8.5/7.5/6.6
			l/s	103.3/95.0/85.0	110.0/95.0/85.0	116.7/103.3/91.7	141.7/125.0/110.0
	External Pressure	Min/Std/Max	mmAq	-	-	-	-
Pa			-	-	-	-	
Fan motor	Type		-	SSR Feedback	SSR Feedback	SSR Feedback	SSR Feedback
	Output x n		-	19W x 1	19W x 1	19W x 1	19W x 1
Piping Connections	Liquid Pipe		Type	Flare connection	Flare connection	Flare connection	Flare connection
			Ø, mm	6.35	6.35	6.35	6.35
			Ø, inch	1/4"	1/4"	1/4"	1/4"
	Gas Pipe		Type	Flare connection	Flare connection	Flare connection	Flare connection
			Ø, mm	12.7	12.7	12.7	12.7
			Ø, inch	1/2"	1/2"	1/2"	1/2"
	Drain Pipe		Ø, mm	ID 18 HOSE	ID 18 HOSE	ID 18 HOSE	ID 18 HOSE
Heat insulation		-	Both liquid and gas pipes	Both liquid and gas pipes	Both liquid and gas pipes	Both liquid and gas pipes	
Field Wiring	Power Source Wire	Minimum	mm ²	1.5	1.5	1.5	1.5
	For connection with indoor	Minimum	mm ²	0.75	0.75	0.75	0.75
		Remark	-	F1, F2	F1, F2	F1, F2	F1, F2
Refrigerant	Type		-	R410A	R410A	R410A	R410A
	Control Method		-	EEV INCLUDED	EEV INCLUDED	EEV INCLUDED	EEV INCLUDED
Sound	Sound Pressure	High/Mid/Low	dB(A)	30/28/25	31/28/25	31/29/26	36/33/29
	Sound Power	Cooling		47	48	48	51
Dimensions	Net Weight		kg	8.5	8.5	9.0	9.0
	Shipping Weight		kg	10.2	10.2	10.6	10.6
	Net Dimensions (W×H×D)		mm	820 x 285 x 227	820 x 285 x 227	820 x 285 x 227	820 x 285 x 227
	Shipping Dimensions (W×H×D)		mm	880 x 280 x 363	880 x 280 x 363	880 x 280 x 363	880 x 280 x 363

NOTE

- Mode : HP(Heat Pump), HR(Heat Recovery)
- Nominal Cooling : Indoor temperature 27°CDB / 19°CWB, Outdoor temperature 35°CDB / 24°CWB, Refrigerant pipe length 7.5m, Level difference 0m.
- Nominal Heating : Indoor temperature 20°CDB / 15°CWB, Outdoor temperature 7°CDB / 6°CWB, Refrigerant pipe length 7.5m, Level difference 0m.
- Sound level was acquired in an anechoic room. Thus actual noise level may be different depending on the installation conditions.
- These products contain R410A which is fluorinated greenhouse gas.
- Specifications may be subject to change without prior notice.
- Select wire size based on the value of MCA

1. Specification

BORACAY

Type			WALL MOUNTED	WALL MOUNTED	WALL MOUNTED
Model CODE			AM045KNQDEH/EU	AM056KNQDEH/EU	AM071KNQDEH/EU
Power Supply			Ø, #, V, Hz	1,2,220-240,50	1,2,220-240,50
Mode			-	HEAT PUMP	HEAT PUMP
Performance	Capacity (Nominal)	Cooling	kW	4.5	5.6
			Btu/h	15,400	19,100
		Heating	kW	5.0	6.3
			Btu/h	17,100	21,500
Power	Power Input (Nominal)	Cooling	W	47.0	48.0
		Heating		47.0	48.0
	Current Input (Nominal)	Cooling	A	0.27	0.27
		Heating		0.27	0.27
	MCA			0.4	0.4
	MFA			15.0	15.0
Heat exchanger	Type		-	Fin & Tube	Fin & Tube
	Material	Fin	-	Al	Al
		Tube	-	Cu	Cu
	Fin Treatment		-	Anti-corrosion	Anti-corrosion
Fan	Type		-	Crossflow Fan	Crossflow Fan
	Quantity		ea	1	1
	Air Flow Rate	H/M/L (UL)	CMM	13.9/12.4/11.2	14.4/12.9/11.2
			l/s	231.7/206.7/186.7	240.0/215.0/186.7
	External Pressure	Min/Std/Max	mmAq	-	-
			Pa	-	-
Fan motor	Type		-	SSR Feedback	SSR Feedback
	Output x n		-	28W x 1	28W x 1
Piping Connections	Liquid Pipe		Type	Flare connection	Flare connection
			Ø, mm	6.35	6.35
			Ø, inch	1/4"	1/4"
	Gas Pipe		Type	Flare connection	Flare connection
			Ø, mm	12.7	12.7
			Ø, inch	1/2"	1/2"
Drain Pipe		Ø, mm	ID 18 HOSE	ID 18 HOSE	
Heat insulation		-	Both liquid and gas pipes	Both liquid and gas pipes	
Field Wiring	Power Source Wire	Minimum	mm2	1.5	1.5
		For connection with indoor	Minimum	mm2	0.75
		Remark	-	F1, F2	F1, F2
Refrigerant	Type		-	R410A	R410A
	Control Method		-	EEV INCLUDED	EEV INCLUDED
Sound	Sound Pressure	High/Mid/Low	dB(A)	38/35/33	39/36/33
	Sound Power	Cooling		53	53
Dimensions	Net Weight		kg	12.5	12.5
	Shipping Weight		kg	14.5	14.5
	Net Dimensions (W×H×D)		mm	1065 x 298 x 243	1065 x 298 x 243
	Shipping Dimensions (W×H×D)		mm	1128 x 299 x 378	1128 x 299 x 378

NOTE

- Mode : HP(Heat Pump), HR(Heat Recovery)
- Nominal Cooling : Indoor temperature 27°CDB / 19°CWB, Outdoor temperature 35°CDB / 24°CWB, Refrigerant pipe length 7.5m, Level difference 0m.
- Nominal Heating : Indoor temperature 20°CDB / 15°CWB, Outdoor temperature 7°CDB / 6°CWB, Refrigerant pipe length 7.5m, Level difference 0m.
- Sound level was acquired in an anechoic room. Thus actual noise level may be different depending on the installation conditions.
- These products contain R410A which is fluorinated greenhouse gas.
- Specifications may be subject to change without prior notice.
- Select wire size based on the value of MCA

2. Summary Table

BORACAY

Performance Characteristics

Model Code	Net Weight (kg)	Fan Speed	Nominal Capacity			Airflow (CMM)	Sound Pressure (dBA)	Sound Power (dBA)
			Cooling (kW)	Sensible (Kw)	Heating (kW)			
AM015KNTDEH/EU (AM015KNQDEH/EU)	8.0 (8.5)	High	1.5	1.0	1.7	6.2	30	47
		Mid	1.2	0.9	1.6	5.7	28	-
		Low	1.0	0.8	1.5	5.1	25	-
AM022KNTDEH/EU (AM022KNQDEH/EU)	8.0 (8.5)	High	2.2	1.5	2.5	6.6	31	48
		Mid	1.6	1.4	2.3	5.7	28	-
		Low	1.3	1.2	2.2	5.1	25	-
AM028KNTDEH/EU (AM028KNQDEH/EU)	8.5 (9.0)	High	2.8	1.9	3.2	7.0	31	48
		Mid	2.1	1.7	3.0	6.2	29	-
		Low	1.7	1.5	2.8	5.5	26	-
AM036KNTDEH/EU (AM036KNQDEH/EU)	8.5 (9.0)	High	3.6	2.4	4.0	8.5	36	51
		Mid	2.6	2.2	3.8	7.5	33	-
		Low	2.1	1.8	3.5	6.6	29	-
AM045KNTDEH/EU (AM045KNQDEH/EU)	12.0 (12.5)	High	4.5	3.1	5.0	13.9	38	53
		Mid	3.2	2.7	4.7	12.4	35	-
		Low	2.6	2.1	4.5	11.2	33	-
AM056KNTDEH/EU (AM056KNQDEH/EU)	12.0 (12.5)	High	5.6	3.8	6.3	14.4	39	53
		Mid	4.0	3.3	6.0	12.9	36	-
		Low	3.1	2.7	5.6	11.2	33	-
AM071KNTDEH/EU (AM071KNQDEH/EU)	12.0 (12.5)	High	6.8	4.6	7.0	15.7	40	55
		Mid	4.7	4.0	6.6	14.1	38	-
		Low	3.7	2.9	6.3	12.9	35	-

Electrical Characteristics

Model Code	Power Supply (Ø, #, V, Hz)	Power Input (W) (C / H)	Current Input (A) (C / H)	MCA (A)	MFA (A)	FLA (A)
AM015KN*DEH/EU	1Ø/220~240V/50Hz	32/34	0.20/0.20	0.3	15	0.22
AM022KN*DEH/EU	1Ø/220~240V/50Hz	32/35	0.20/0.20	0.3	15	0.22
AM028KN*DEH/EU	1Ø/220~240V/50Hz	38/39	0.22/0.22	0.4	15	0.25
AM036KN*DEH/EU	1Ø/220~240V/50Hz	42/42	0.23/0.23	0.4	15	0.25
AM045KN*DEH/EU	1Ø/220~240V/50Hz	47/47	0.27/0.27	0.4	15	0.30
AM056KN*DEH/EU	1Ø/220~240V/50Hz	48/48	0.27/0.27	0.4	15	0.30
AM071KN*DEH/EU	1Ø/220~240V/50Hz	51/53	0.28/0.28	0.4	15	0.30

NOTE

- MCA : Minimum circuit amperes
- MFA : Maximum fuse amperes
- Select wire size based on the value of MCA

3. Capacity Table

Cooling

TC: Total Capacity, SHC: Sensible Heat Capacity

Capacity Index	Outdoor Air Temp. (°C, DB)	Indoor temperature													
		20(°C, DB)		23(°C, DB)		26(°C, DB)		27(°C, DB)		28(°C, DB)		30(°C, DB)		32(°C, DB)	
		14(°C, WB)		16(°C, WB)		18(°C, WB)		19(°C, WB)		20(°C, WB)		22(°C, WB)		24(°C, WB)	
		TC	SHC	TC	SHC	TC	SHC	TC	SHC	TC	SHC	TC	SHC	TC	SHC
015	10	1.0	0.9	1.2	1.0	1.4	1.0	1.5	1.0	1.6	1.0	1.7	1.1	1.8	1.0
	12	1.0	0.9	1.2	1.0	1.4	1.0	1.5	1.0	1.6	1.0	1.7	1.1	1.8	1.0
	14	1.0	0.9	1.2	1.0	1.4	1.0	1.5	1.0	1.6	1.0	1.7	1.1	1.8	1.0
	16	1.0	0.9	1.2	1.0	1.4	1.0	1.5	1.0	1.6	1.0	1.6	1.1	1.8	1.0
	18	1.0	0.9	1.2	1.0	1.4	1.0	1.5	1.0	1.6	1.0	1.6	1.1	1.8	1.0
	20	1.0	0.9	1.2	1.0	1.4	1.0	1.5	1.0	1.6	1.0	1.6	1.1	1.8	1.0
	21	1.0	0.9	1.2	1.0	1.4	1.0	1.5	1.0	1.6	1.0	1.6	1.1	1.8	1.0
	23	1.0	0.9	1.2	1.0	1.4	1.0	1.5	1.0	1.6	1.0	1.6	1.1	1.8	1.0
	25	1.0	0.9	1.2	1.0	1.4	1.0	1.5	1.0	1.6	1.0	1.6	1.1	1.8	1.0
	27	1.0	0.9	1.2	1.0	1.4	1.0	1.5	1.0	1.6	1.0	1.6	1.1	1.8	1.0
	29	1.0	0.9	1.2	1.0	1.4	1.0	1.5	1.0	1.6	1.0	1.6	1.1	1.8	1.0
	31	1.0	0.9	1.2	1.0	1.4	1.0	1.5	1.0	1.6	1.0	1.6	1.1	1.8	1.0
	33	1.0	0.9	1.2	1.0	1.4	1.0	1.5	1.0	1.6	1.0	1.6	1.1	1.8	1.0
	35	1.0	0.9	1.2	1.0	1.4	1.0	1.5	1.0	1.6	1.0	1.6	1.1	1.8	1.0
	37	1.0	0.9	1.2	1.0	1.4	1.0	1.5	1.0	1.6	1.0	1.6	1.1	1.8	1.0
39	1.0	0.9	1.2	1.0	1.4	1.0	1.5	1.0	1.6	1.0	1.6	1.1	1.7	0.9	
42	1.0	0.9	1.2	1.0	1.4	1.0	1.5	1.0	1.6	1.0	1.6	1.1	1.7	0.9	
44	1.0	0.9	1.2	1.0	1.4	1.0	1.4	1.0	1.5	1.0	1.5	1.0	1.6	0.8	
46	1.0	0.9	1.2	1.0	1.3	1.0	1.4	0.9	1.5	0.9	1.5	1.0	1.6	0.8	
48	1.0	0.9	1.2	1.0	1.3	0.9	1.3	0.9	1.5	0.9	1.4	1.0	1.5	0.8	
022	10	1.5	1.3	1.8	1.5	2.1	1.5	2.2	1.5	2.3	1.5	2.5	1.6	2.6	1.4
	12	1.5	1.3	1.8	1.5	2.1	1.5	2.2	1.5	2.3	1.5	2.5	1.6	2.6	1.4
	14	1.5	1.3	1.8	1.5	2.1	1.5	2.2	1.5	2.3	1.5	2.5	1.6	2.6	1.4
	16	1.5	1.3	1.8	1.5	2.1	1.5	2.2	1.5	2.3	1.5	2.4	1.5	2.6	1.4
	18	1.5	1.3	1.8	1.5	2.1	1.5	2.2	1.5	2.3	1.5	2.4	1.5	2.6	1.4
	20	1.5	1.3	1.8	1.5	2.1	1.5	2.2	1.5	2.3	1.5	2.4	1.5	2.6	1.4
	21	1.5	1.3	1.8	1.5	2.1	1.5	2.2	1.5	2.3	1.5	2.4	1.5	2.6	1.4
	23	1.5	1.3	1.8	1.5	2.1	1.5	2.2	1.5	2.3	1.5	2.4	1.5	2.6	1.4
	25	1.5	1.3	1.8	1.5	2.1	1.5	2.2	1.5	2.3	1.5	2.4	1.5	2.6	1.4
	27	1.5	1.3	1.8	1.5	2.1	1.5	2.2	1.5	2.3	1.5	2.4	1.5	2.6	1.4
	29	1.5	1.3	1.8	1.5	2.1	1.5	2.2	1.5	2.3	1.5	2.4	1.5	2.6	1.4
	31	1.5	1.3	1.8	1.5	2.1	1.5	2.2	1.5	2.3	1.5	2.4	1.5	2.6	1.4
	33	1.5	1.3	1.8	1.5	2.1	1.5	2.2	1.5	2.3	1.5	2.4	1.5	2.6	1.4
	35	1.5	1.3	1.8	1.5	2.1	1.5	2.2	1.5	2.3	1.5	2.4	1.5	2.6	1.4
	37	1.5	1.3	1.8	1.5	2.1	1.5	2.2	1.5	2.3	1.5	2.4	1.5	2.6	1.4
39	1.5	1.3	1.8	1.5	2.1	1.5	2.2	1.5	2.3	1.5	2.4	1.5	2.5	1.3	
42	1.5	1.3	1.8	1.5	2.1	1.5	2.2	1.5	2.3	1.5	2.4	1.5	2.4	1.3	
44	1.5	1.3	1.8	1.5	2.0	1.4	2.1	1.4	2.2	1.4	2.3	1.4	2.4	1.2	
46	1.5	1.3	1.8	1.5	2.0	1.4	2.0	1.4	2.1	1.4	2.2	1.4	2.3	1.2	
48	1.5	1.3	1.8	1.5	2.0	1.4	2.0	1.3	2.1	1.4	2.1	1.3	2.2	1.1	
028	10	1.9	1.6	2.3	1.8	2.6	2.0	2.8	1.9	2.9	1.9	3.1	1.9	3.4	1.9
	12	1.9	1.6	2.3	1.8	2.6	2.0	2.8	1.9	2.9	1.9	3.1	1.9	3.3	1.8
	14	1.9	1.6	2.3	1.8	2.6	2.0	2.8	1.9	2.9	1.9	3.1	1.9	3.3	1.8
	16	1.9	1.6	2.3	1.8	2.6	2.0	2.8	1.9	2.9	1.9	3.1	1.9	3.3	1.8
	18	1.9	1.6	2.3	1.8	2.6	2.0	2.8	1.9	2.9	1.9	3.1	1.9	3.3	1.8
	20	1.9	1.6	2.3	1.8	2.6	2.0	2.8	1.9	2.9	1.9	3.1	1.9	3.3	1.8
	21	1.9	1.6	2.3	1.8	2.6	2.0	2.8	1.9	2.9	1.9	3.1	1.9	3.3	1.8
	23	1.9	1.6	2.3	1.8	2.6	2.0	2.8	1.9	2.9	1.9	3.1	1.9	3.3	1.8
	25	1.9	1.6	2.3	1.8	2.6	2.0	2.8	1.9	2.9	1.9	3.1	1.9	3.3	1.8
	27	1.9	1.6	2.3	1.8	2.6	2.0	2.8	1.9	2.9	1.9	3.1	1.9	3.3	1.8
	29	1.9	1.6	2.3	1.8	2.6	2.0	2.8	1.9	2.9	1.9	3.1	1.9	3.3	1.8
	31	1.9	1.6	2.3	1.8	2.6	2.0	2.8	1.9	2.9	1.9	3.1	1.9	3.3	1.8
	33	1.9	1.6	2.3	1.8	2.6	2.0	2.8	1.9	2.9	1.9	3.1	1.9	3.3	1.8
	35	1.9	1.6	2.3	1.8	2.6	2.0	2.8	1.9	2.9	1.9	3.1	1.9	3.3	1.8
	37	1.9	1.6	2.3	1.8	2.6	2.0	2.8	1.9	2.9	1.9	3.1	1.9	3.3	1.8
39	1.9	1.6	2.3	1.8	2.6	2.0	2.8	1.9	2.9	1.9	3.0	1.8	3.2	1.7	
42	1.9	1.6	2.3	1.8	2.6	2.0	2.8	1.9	2.9	1.9	2.9	1.8	3.1	1.7	
44	1.9	1.6	2.3	1.8	2.5	1.9	2.7	1.8	2.8	1.8	2.8	1.7	3.0	1.6	
46	1.9	1.6	2.3	1.8	2.5	1.9	2.6	1.8	2.7	1.8	2.7	1.6	2.9	1.6	
48	1.9	1.6	2.2	1.8	2.4	1.9	2.5	1.7	2.6	1.7	2.7	1.6	2.8	1.5	

3. Capacity Table

Cooling

TC: Total Capacity, SHC: Sensible Heat Capacity

Capacity Index	Outdoor Air Temp. (°C, DB)	Indoor temperature													
		20(°C, DB)		23(°C, DB)		26(°C, DB)		27(°C, DB)		28(°C, DB)		30(°C, DB)		32(°C, DB)	
		14(°C, WB)		16(°C, WB)		18(°C, WB)		19(°C, WB)		20(°C, WB)		22(°C, WB)		24(°C, WB)	
		TC	SHC	TC	SHC	TC	SHC	TC	SHC	TC	SHC	TC	SHC	TC	SHC
036	10	2.5	2.1	2.9	2.2	3.4	2.3	3.6	2.4	3.7	2.4	4.0	2.4	4.3	2.3
	12	2.5	2.1	2.9	2.2	3.4	2.3	3.6	2.4	3.7	2.4	4.0	2.4	4.3	2.3
	14	2.5	2.1	2.9	2.2	3.4	2.3	3.6	2.4	3.7	2.4	4.0	2.4	4.3	2.3
	16	2.5	2.1	2.9	2.2	3.4	2.3	3.6	2.4	3.7	2.4	4.0	2.4	4.3	2.3
	18	2.5	2.1	2.9	2.2	3.4	2.3	3.6	2.4	3.7	2.4	4.0	2.4	4.3	2.3
	20	2.5	2.1	2.9	2.2	3.4	2.3	3.6	2.4	3.7	2.4	4.0	2.4	4.2	2.3
	21	2.5	2.1	2.9	2.2	3.4	2.3	3.6	2.4	3.7	2.4	4.0	2.4	4.2	2.3
	23	2.5	2.1	2.9	2.2	3.4	2.3	3.6	2.4	3.7	2.4	4.0	2.4	4.2	2.3
	25	2.5	2.1	2.9	2.2	3.4	2.3	3.6	2.4	3.7	2.4	4.0	2.4	4.2	2.3
	27	2.5	2.1	2.9	2.2	3.4	2.3	3.6	2.4	3.7	2.4	4.0	2.4	4.2	2.3
	29	2.5	2.1	2.9	2.2	3.4	2.3	3.6	2.4	3.7	2.4	4.0	2.4	4.2	2.3
	31	2.5	2.1	2.9	2.2	3.4	2.3	3.6	2.4	3.7	2.4	4.0	2.4	4.2	2.3
	33	2.5	2.1	2.9	2.2	3.4	2.3	3.6	2.4	3.7	2.4	4.0	2.4	4.2	2.3
	35	2.5	2.1	2.9	2.2	3.4	2.3	3.6	2.4	3.7	2.4	4.0	2.4	4.2	2.3
	37	2.5	2.1	2.9	2.2	3.4	2.3	3.6	2.4	3.7	2.4	3.9	2.3	4.2	2.3
	39	2.5	2.1	2.9	2.2	3.4	2.3	3.6	2.4	3.7	2.4	3.9	2.3	4.1	2.2
42	2.5	2.1	2.9	2.2	3.4	2.3	3.6	2.4	3.7	2.4	3.8	2.3	4.0	2.1	
44	2.5	2.1	2.9	2.2	3.3	2.2	3.4	2.3	3.6	2.3	3.7	2.2	3.9	2.1	
46	2.5	2.1	2.9	2.2	3.2	2.2	3.3	2.2	3.4	2.2	3.6	2.1	3.8	2.0	
48	2.5	2.1	2.8	2.2	3.2	2.1	3.2	2.2	3.4	2.2	3.5	2.0	3.6	1.9	
045	10	3.1	2.4	3.7	2.7	4.3	2.9	4.5	3.0	4.7	3.0	5.1	3.1	5.4	2.8
	12	3.1	2.4	3.7	2.7	4.3	2.9	4.5	3.0	4.7	3.0	5.1	3.1	5.4	2.8
	14	3.1	2.4	3.7	2.7	4.3	2.9	4.5	3.0	4.7	3.0	5.0	3.0	5.4	2.8
	16	3.1	2.4	3.7	2.7	4.3	2.9	4.5	3.0	4.7	3.0	5.0	3.0	5.3	2.8
	18	3.1	2.4	3.7	2.7	4.3	2.9	4.5	3.0	4.7	3.0	5.0	3.0	5.3	2.8
	20	3.1	2.4	3.7	2.7	4.3	2.9	4.5	3.0	4.7	3.0	5.0	3.0	5.3	2.8
	21	3.1	2.4	3.7	2.7	4.3	2.9	4.5	3.0	4.7	3.0	5.0	3.0	5.3	2.8
	23	3.1	2.4	3.7	2.7	4.3	2.9	4.5	3.0	4.7	3.0	5.0	3.0	5.3	2.8
	25	3.1	2.4	3.7	2.7	4.3	2.9	4.5	3.0	4.7	3.0	5.0	3.0	5.3	2.8
	27	3.1	2.4	3.7	2.7	4.3	2.9	4.5	3.0	4.7	3.0	5.0	3.0	5.3	2.8
	29	3.1	2.4	3.7	2.7	4.3	2.9	4.5	3.0	4.7	3.0	5.0	3.0	5.3	2.8
	31	3.1	2.4	3.7	2.7	4.3	2.9	4.5	3.0	4.7	3.0	5.0	3.0	5.3	2.8
	33	3.1	2.4	3.7	2.7	4.3	2.9	4.5	3.0	4.7	3.0	5.0	3.0	5.3	2.8
	35	3.1	2.4	3.7	2.7	4.3	2.9	4.5	3.0	4.7	3.0	5.0	3.0	5.3	2.8
	37	3.1	2.4	3.7	2.7	4.3	2.9	4.5	3.0	4.7	3.0	4.9	2.9	5.2	2.7
	39	3.1	2.4	3.7	2.7	4.3	2.9	4.5	3.0	4.7	3.0	4.9	2.9	5.1	2.6
42	3.1	2.4	3.7	2.7	4.2	2.9	4.4	3.0	4.6	3.0	4.8	2.9	5.0	2.5	
44	3.1	2.4	3.7	2.7	4.1	2.8	4.3	2.9	4.5	2.9	4.6	2.8	4.8	2.5	
46	3.1	2.4	3.7	2.7	4.0	2.8	4.2	2.8	4.3	2.8	4.5	2.7	4.7	2.4	
48	3.1	2.3	3.6	2.6	4.0	2.7	4.0	2.7	4.3	2.7	4.3	2.6	4.5	2.3	
056	10	3.9	3.0	4.6	3.4	5.3	3.7	5.6	3.8	5.8	3.8	6.3	3.9	6.7	3.6
	12	3.9	3.0	4.6	3.4	5.3	3.7	5.6	3.8	5.8	3.8	6.3	3.9	6.7	3.6
	14	3.9	3.0	4.6	3.4	5.3	3.7	5.6	3.8	5.8	3.8	6.2	3.8	6.7	3.6
	16	3.9	3.0	4.6	3.4	5.3	3.7	5.6	3.8	5.8	3.8	6.2	3.8	6.6	3.5
	18	3.9	3.0	4.6	3.4	5.3	3.7	5.6	3.8	5.8	3.8	6.2	3.8	6.6	3.5
	20	3.9	3.0	4.6	3.4	5.3	3.7	5.6	3.8	5.8	3.8	6.2	3.8	6.6	3.5
	21	3.9	3.0	4.6	3.4	5.3	3.7	5.6	3.8	5.8	3.8	6.2	3.8	6.6	3.5
	23	3.9	3.0	4.6	3.4	5.3	3.7	5.6	3.8	5.8	3.8	6.2	3.8	6.6	3.5
	25	3.9	3.0	4.6	3.4	5.3	3.7	5.6	3.8	5.8	3.8	6.2	3.8	6.6	3.5
	27	3.9	3.0	4.6	3.4	5.3	3.7	5.6	3.8	5.8	3.8	6.2	3.8	6.6	3.5
	29	3.9	3.0	4.6	3.4	5.3	3.7	5.6	3.8	5.8	3.8	6.2	3.8	6.6	3.5
	31	3.9	3.0	4.6	3.4	5.3	3.7	5.6	3.8	5.8	3.8	6.2	3.8	6.6	3.5
	33	3.9	3.0	4.6	3.4	5.3	3.7	5.6	3.8	5.8	3.8	6.2	3.8	6.6	3.5
	35	3.9	3.0	4.6	3.4	5.3	3.7	5.6	3.8	5.8	3.8	6.2	3.8	6.6	3.5
	37	3.9	3.0	4.6	3.4	5.3	3.7	5.6	3.8	5.8	3.8	6.1	3.7	6.5	3.4
	39	3.9	3.0	4.6	3.4	5.3	3.7	5.6	3.8	5.8	3.8	6.1	3.7	6.4	3.3
42	3.9	3.0	4.6	3.4	5.3	3.7	5.5	3.7	5.7	3.8	6.0	3.6	6.2	3.2	
44	3.9	3.0	4.6	3.4	5.1	3.6	5.3	3.6	5.6	3.6	5.8	3.5	6.0	3.1	
46	3.9	3.0	4.6	3.4	5.0	3.5	5.2	3.5	5.4	3.5	5.6	3.4	5.9	3.0	
48	3.9	3.0	4.5	3.3	5.0	3.5	5.0	3.4	5.3	3.5	5.4	3.3	5.7	2.9	

3. Capacity Table

Cooling

TC: Total Capacity, SHC: Sensible Heat Capacity

Capacity Index	Outdoor Air Temp. (°C, DB)	Indoor temperature													
		20(°C, DB)		23(°C, DB)		26(°C, DB)		27(°C, DB)		28(°C, DB)		30(°C, DB)		32(°C, DB)	
		14(°C, WB)		16(°C, WB)		18(°C, WB)		19(°C, WB)		20(°C, WB)		22(°C, WB)		24(°C, WB)	
		TC	SHC	TC	SHC	TC	SHC	TC	SHC	TC	SHC	TC	SHC	TC	SHC
071	10	4.9	3.9	5.7	4.3	6.7	4.7	7.1	4.8	7.4	4.8	7.9	4.8	8.6	4.6
	12	4.9	3.9	5.7	4.3	6.7	4.7	7.1	4.8	7.4	4.8	7.9	4.8	8.5	4.5
	14	4.9	3.9	5.7	4.3	6.7	4.7	7.1	4.8	7.4	4.8	7.9	4.8	8.5	4.5
	16	4.9	3.9	5.7	4.3	6.7	4.7	7.1	4.8	7.4	4.8	7.9	4.8	8.5	4.5
	18	4.9	3.9	5.7	4.3	6.7	4.7	7.1	4.8	7.3	4.8	7.8	4.7	8.4	4.4
	20	4.9	3.9	5.7	4.3	6.7	4.7	7.1	4.8	7.3	4.8	7.8	4.7	8.4	4.4
	21	4.9	3.9	5.7	4.3	6.7	4.7	7.1	4.8	7.3	4.8	7.8	4.7	8.4	4.4
	23	4.9	3.9	5.7	4.3	6.7	4.7	7.1	4.8	7.3	4.8	7.8	4.7	8.4	4.4
	25	4.9	3.9	5.7	4.3	6.7	4.7	7.1	4.8	7.3	4.8	7.8	4.7	8.4	4.4
	27	4.9	3.9	5.7	4.3	6.7	4.7	7.1	4.8	7.3	4.8	7.8	4.7	8.4	4.4
	29	4.9	3.9	5.7	4.3	6.7	4.7	7.1	4.8	7.3	4.8	7.8	4.7	8.4	4.4
	31	4.9	3.9	5.7	4.3	6.7	4.7	7.1	4.8	7.3	4.8	7.8	4.7	8.4	4.4
	33	4.9	3.9	5.7	4.3	6.7	4.7	7.1	4.8	7.3	4.8	7.8	4.7	8.4	4.4
	35	4.9	3.9	5.7	4.3	6.7	4.7	7.1	4.8	7.3	4.8	7.8	4.7	8.4	4.4
	37	4.9	3.9	5.7	4.3	6.7	4.7	7.1	4.8	7.3	4.8	7.8	4.7	8.2	4.3
	39	4.9	3.9	5.7	4.3	6.7	4.7	7.1	4.8	7.3	4.8	7.7	4.6	8.0	4.2
	42	4.9	3.9	5.7	4.3	6.6	4.7	7.0	4.7	7.2	4.7	7.6	4.5	7.8	4.1
44	4.9	3.9	5.7	4.3	6.5	4.5	6.8	4.6	7.0	4.6	7.3	4.3	7.6	3.9	
46	4.9	3.9	5.7	4.2	6.3	4.5	6.6	4.4	6.8	4.5	7.1	4.2	7.4	3.8	
48	4.8	3.8	5.6	4.2	6.2	4.4	6.4	4.3	6.7	4.4	6.9	4.1	7.1	3.7	

3. Capacity Table

Heating

TC: Total Capacity

Capacity Index	Outdoor Air Temp. (°C)		Indoor temperature (°C,DB)				
			16(°C,DB)	18(°C,DB)	20(°C,DB)	22(°C,DB)	24(°C,DB)
	DB	WB	TC kW	TC kW	TC kW	TC kW	TC kW
015	-19.8	-20.0	1.0	1.0	1.0	1.0	1.0
	-18.8	-19.0	1.0	1.0	1.0	1.0	1.0
	-16.7	-17.0	1.1	1.1	1.1	1.1	1.1
	-14.7	-15.0	1.2	1.1	1.1	1.1	1.1
	-12.6	-13.0	1.2	1.2	1.2	1.2	1.2
	-10.5	-11.0	1.4	1.4	1.3	1.3	1.3
	-9.5	-10.0	1.4	1.4	1.3	1.3	1.3
	-8.5	-9.1	1.5	1.5	1.4	1.4	1.4
	-7.0	-7.6	1.6	1.5	1.5	1.4	1.4
	-5.0	-5.6	1.6	1.6	1.6	1.5	1.5
	-3.0	-3.7	1.7	1.7	1.6	1.6	1.5
	0.0	-0.7	1.8	1.7	1.7	1.6	1.5
	3.0	2.2	1.8	1.8	1.7	1.6	1.5
	5.0	4.1	1.9	1.8	1.7	1.6	1.5
	7.0	6.0	1.9	1.8	1.7	1.6	1.5
9.0	7.9	2.0	1.8	1.7	1.6	1.5	
11.0	9.8	2.0	1.8	1.7	1.6	1.5	
13.0	11.8	2.0	1.8	1.7	1.6	1.5	
15.0	13.7	2.0	1.8	1.7	1.6	1.5	
022	-19.8	-20.0	1.5	1.5	1.5	1.5	1.5
	-18.8	-19.0	1.5	1.5	1.5	1.5	1.5
	-16.7	-17.0	1.6	1.6	1.6	1.6	1.6
	-14.7	-15.0	1.7	1.6	1.6	1.6	1.6
	-12.6	-13.0	1.8	1.8	1.8	1.8	1.7
	-10.5	-11.0	2.0	2.0	1.9	1.9	1.9
	-9.5	-10.0	2.1	2.0	2.0	1.9	1.9
	-8.5	-9.1	2.2	2.1	2.1	2.0	2.0
	-7.0	-7.6	2.3	2.2	2.2	2.0	2.0
	-5.0	-5.6	2.4	2.3	2.3	2.2	2.2
	-3.0	-3.7	2.5	2.5	2.4	2.3	2.2
	0.0	-0.7	2.6	2.5	2.5	2.3	2.2
	3.0	2.2	2.7	2.6	2.5	2.3	2.2
	5.0	4.1	2.8	2.7	2.5	2.3	2.2
	7.0	6.0	2.8	2.7	2.5	2.3	2.2
9.0	7.9	3.0	2.7	2.5	2.3	2.2	
11.0	9.8	3.0	2.7	2.5	2.3	2.2	
13.0	11.8	3.0	2.7	2.5	2.3	2.2	
15.0	13.7	3.0	2.7	2.5	2.3	2.2	
028	-19.8	-20.0	1.9	1.9	1.9	1.9	1.9
	-18.8	-19.0	1.9	1.9	1.9	1.9	1.9
	-16.7	-17.0	2.0	2.0	2.0	2.0	1.9
	-14.7	-15.0	2.1	2.1	2.0	2.0	1.9
	-12.6	-13.0	2.2	2.2	2.2	2.1	2.1
	-10.5	-11.0	2.3	2.3	2.3	2.3	2.2
	-9.5	-10.0	2.3	2.3	2.3	2.3	2.2
	-8.5	-9.1	2.4	2.4	2.4	2.4	2.3
	-7.0	-7.6	2.5	2.4	2.4	2.4	2.3
	-5.0	-5.6	2.6	2.6	2.5	2.5	2.4
	-3.0	-3.7	2.8	2.7	2.7	2.6	2.5
	0.0	-0.7	2.9	2.8	2.8	2.7	2.6
	3.0	2.2	3.0	3.0	2.9	2.8	2.7
	5.0	4.1	3.2	3.1	3.1	2.9	2.7
	7.0	6.0	3.3	3.2	3.2	3.0	2.7
9.0	7.9	3.4	3.3	3.2	3.0	2.7	
11.0	9.8	3.5	3.3	3.2	3.0	2.7	
13.0	11.8	3.6	3.4	3.2	3.0	2.7	
15.0	13.7	3.7	3.4	3.2	3.0	2.7	

3. Capacity Table

Heating

TC: Total Capacity

Capacity Index	Outdoor Air Temp. (°C)		Indoor temperature (°C,DB)				
			16(°C,DB)	18(°C,DB)	20(°C,DB)	22(°C,DB)	24(°C,DB)
	DB	WB	TC kW	TC kW	TC kW	TC kW	TC kW
036	-19.8	-20.0	2.4	2.4	2.3	2.3	2.3
	-18.8	-19.0	2.5	2.4	2.3	2.3	2.3
	-16.7	-17.0	2.6	2.5	2.4	2.4	2.3
	-14.7	-15.0	2.7	2.6	2.5	2.5	2.4
	-12.6	-13.0	2.8	2.7	2.7	2.6	2.6
	-10.5	-11.0	2.9	2.9	2.9	2.8	2.8
	-9.5	-10.0	2.9	2.9	2.9	2.8	2.8
	-8.5	-9.1	3.0	3.0	3.0	2.9	2.9
	-7.0	-7.6	3.1	3.1	3.0	3.0	2.9
	-5.0	-5.6	3.3	3.2	3.2	3.1	3.0
	-3.0	-3.7	3.4	3.4	3.3	3.2	3.1
	0.0	-0.7	3.6	3.6	3.5	3.4	3.2
	3.0	2.2	3.8	3.7	3.7	3.5	3.4
	5.0	4.1	3.9	3.9	3.8	3.6	3.4
	7.0	6.0	4.1	4.1	4.0	3.7	3.4
9.0	7.9	4.2	4.1	4.0	3.7	3.4	
11.0	9.8	4.4	4.2	4.0	3.7	3.4	
13.0	11.8	4.5	4.2	4.0	3.7	3.4	
15.0	13.7	4.6	4.3	4.0	3.7	3.4	
045	-19.8	-20.0	3.1	3.0	3.0	2.9	2.9
	-18.8	-19.0	3.1	3.1	3.1	3.0	3.0
	-16.7	-17.0	3.2	3.2	3.1	3.0	3.0
	-14.7	-15.0	3.3	3.3	3.2	3.1	3.0
	-12.6	-13.0	3.5	3.4	3.3	3.3	3.2
	-10.5	-11.0	3.6	3.6	3.5	3.5	3.4
	-9.5	-10.0	3.7	3.7	3.6	3.5	3.5
	-8.5	-9.1	3.8	3.7	3.7	3.6	3.5
	-7.0	-7.6	3.9	3.8	3.8	3.7	3.6
	-5.0	-5.6	4.1	4.1	4.0	3.9	3.7
	-3.0	-3.7	4.3	4.2	4.2	4.1	3.9
	0.0	-0.7	4.5	4.4	4.4	4.2	4.0
	3.0	2.2	4.7	4.7	4.6	4.4	4.2
	5.0	4.1	4.9	4.8	4.8	4.5	4.2
	7.0	6.0	5.2	5.1	5.0	4.6	4.2
9.0	7.9	5.3	5.2	5.0	4.6	4.2	
11.0	9.8	5.5	5.2	5.0	4.6	4.2	
13.0	11.8	5.6	5.3	5.0	4.6	4.2	
15.0	13.7	5.8	5.4	5.0	4.6	4.2	
056	-19.8	-20.0	3.9	3.8	3.8	3.7	3.7
	-18.8	-19.0	3.9	3.9	3.8	3.7	3.7
	-16.7	-17.0	4.0	4.0	3.9	3.8	3.8
	-14.7	-15.0	4.2	4.1	4.0	3.9	3.8
	-12.6	-13.0	4.4	4.3	4.2	4.1	4.0
	-10.5	-11.0	4.6	4.5	4.4	4.4	4.3
	-9.5	-10.0	4.7	4.6	4.6	4.5	4.4
	-8.5	-9.1	4.8	4.7	4.7	4.6	4.5
	-7.0	-7.6	4.9	4.8	4.8	4.7	4.5
	-5.0	-5.6	5.2	5.1	5.0	4.9	4.7
	-3.0	-3.7	5.4	5.3	5.3	5.1	4.9
	0.0	-0.7	5.7	5.6	5.5	5.3	5.0
	3.0	2.2	5.9	5.9	5.8	5.6	5.3
	5.0	4.1	6.2	6.1	6.0	5.7	5.3
	7.0	6.0	6.5	6.4	6.3	5.8	5.3
9.0	7.9	6.7	6.5	6.3	5.8	5.3	
11.0	9.8	6.9	6.6	6.3	5.8	5.3	
13.0	11.8	7.1	6.7	6.3	5.8	5.3	
15.0	13.7	7.3	6.8	6.3	5.8	5.3	

3. Capacity Table

Heating

TC: Total Capacity

Capacity Index	Outdoor Air Temp. (°C)		Indoor temperature (°C,DB)				
			16(°C,DB)	18(°C,DB)	20(°C,DB)	22(°C,DB)	24(°C,DB)
	DB	WB	TC kW	TC kW	TC kW	TC kW	TC kW
071	-19.8	-20.0	5.0	4.9	4.8	4.8	4.8
	-18.8	-19.0	5.1	5.0	4.8	4.8	4.8
	-16.7	-17.0	5.2	5.1	4.9	4.9	4.8
	-14.7	-15.0	5.4	5.3	5.1	4.9	4.8
	-12.6	-13.0	5.6	5.4	5.3	5.2	5.1
	-10.5	-11.0	5.8	5.7	5.6	5.5	5.5
	-9.5	-10.0	5.9	5.9	5.8	5.7	5.6
	-8.5	-9.1	6.0	6.0	5.9	5.8	5.7
	-7.0	-7.6	6.2	6.2	6.1	5.9	5.8
	-5.0	-5.6	6.5	6.4	6.4	6.2	5.9
	-3.0	-3.7	6.9	6.7	6.7	6.4	6.2
	0.0	-0.7	7.2	7.1	7.0	6.7	6.4
	3.0	2.2	7.5	7.4	7.3	7.1	6.7
	5.0	4.1	7.9	7.8	7.7	7.2	6.7
	7.0	6.0	8.2	8.1	8.0	7.4	6.7
	9.0	7.9	8.5	8.2	8.0	7.4	6.7
11.0	9.8	8.7	8.3	8.0	7.4	6.7	
13.0	11.8	9.0	8.5	8.0	7.4	6.7	
15.0	13.7	9.3	8.6	8.0	7.4	6.7	

4. Dimensional Drawing

BORACAY

AM015/022/028/036KN*D*****

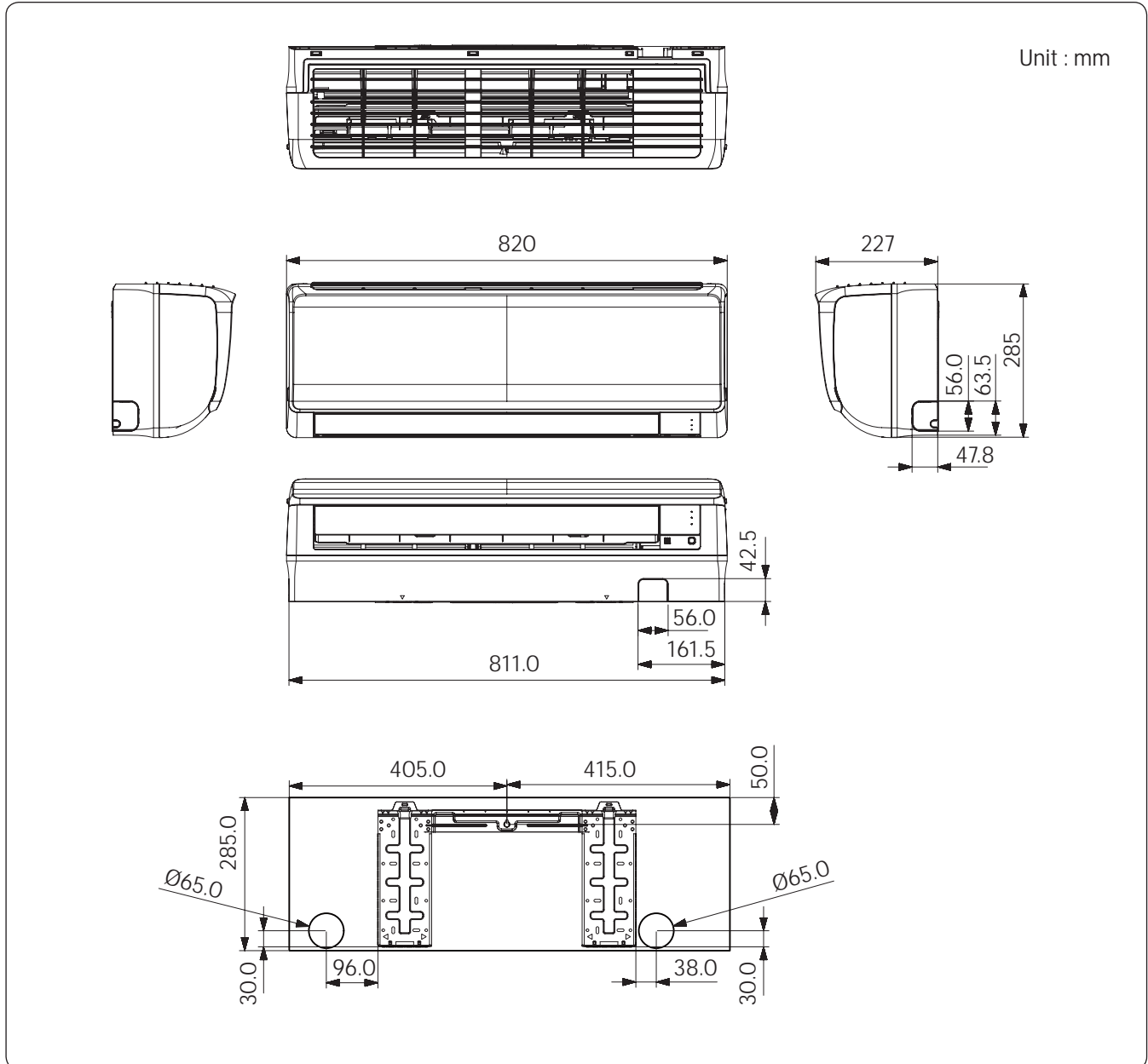

No.	Name	Description
1	Liquid pipe connection	Ø6.35 (Ø1/4)
2	Gas pipe connection	Ø12.7 (Ø1/2)
3	Drain pipe connection	ID 18 HOSE
4	Power & Communication wiring conduit	

5. Center of Gravity

BORACAY

AM015/022/028/036KN*D*****

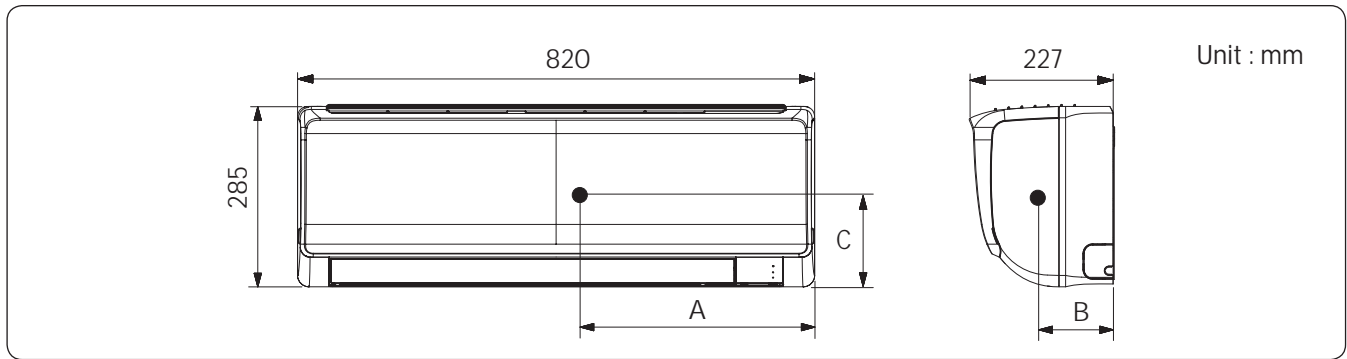

A	B	C
375	105	155

AM045/056/071KN*D*****

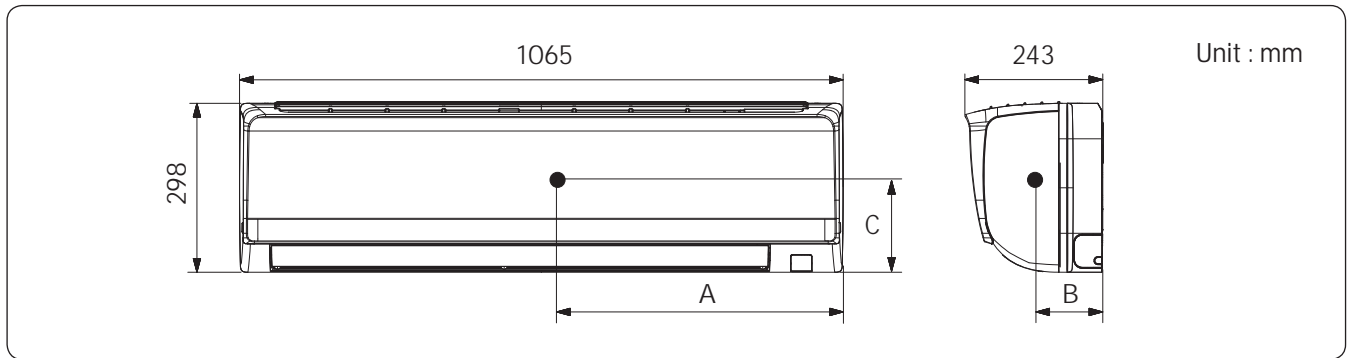

A	B	C
460	120	160

6. Electrical Wiring Diagram

BORACAY

AM***KN*D****

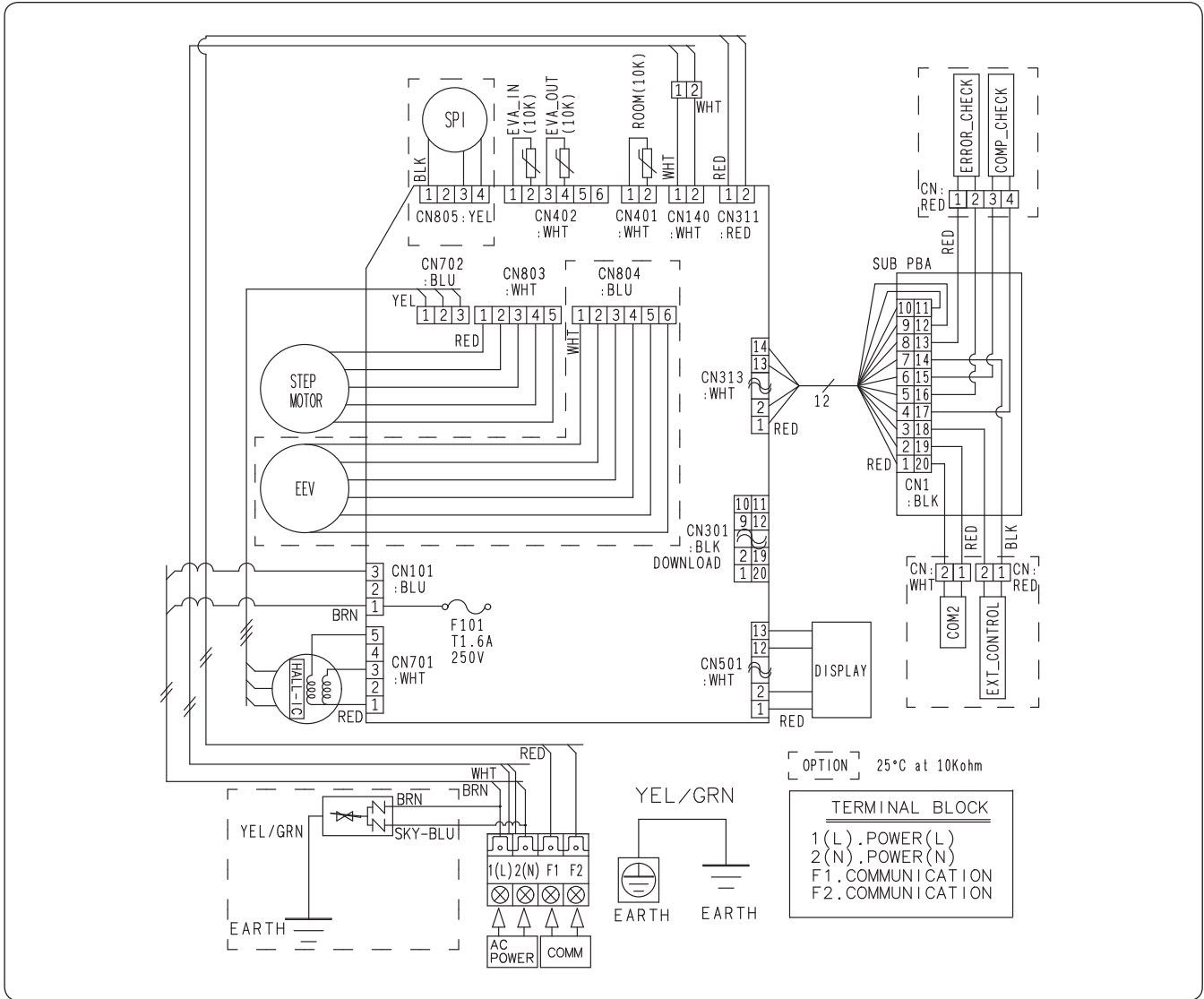

SUB PBA	Printed Circuit Board(SUB)	SPI	S-Plasma ion	EVA-OUT(10K)	Thermistor EVA OUT(10K)
[HALL IC]	Motor For FAN	ROOM(10K)	Thermistor ROOM In(10K)	EVA-IN(10K)	Thermistor EVA IN(10K)
EEV	electronic expansion valve				

NOTE

- This wiring diagram applies only to the Indoor unit.
- Symbols show as follow :
BLK: black, RED: red, BLU: blue, WHT: white, YEL: yellow, BRN: brown, sky: sky blue, GRN: green
- For connection wiring indoor-outdoor transmission F1-F2, indoor-wired remote controller transmission F3-F4.
- Protective earth(SCREW)

EARTH EARTH

7. Sound Data

BORACAY

Sound Pressure Level

Unit: dB(A)

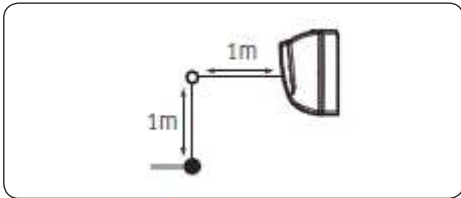

MODEL	Hi	MID	LOW
AM015KN*D*****	30	28	25
AM022KN*D*****	31	28	25
AM028KN*D*****	31	29	26
AM036KN*D*****	36	33	29

NR Curve

1) AM015KN*D*****

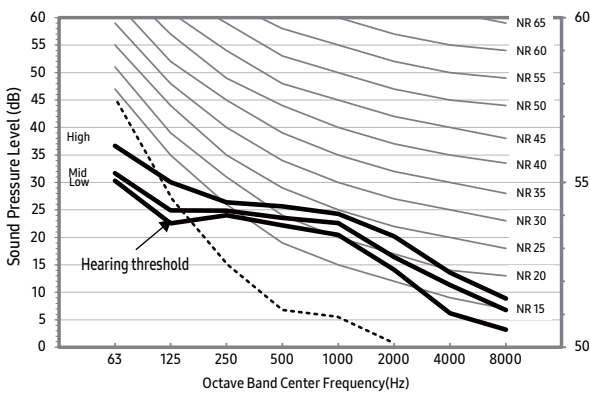

2) AM022KN*D*****

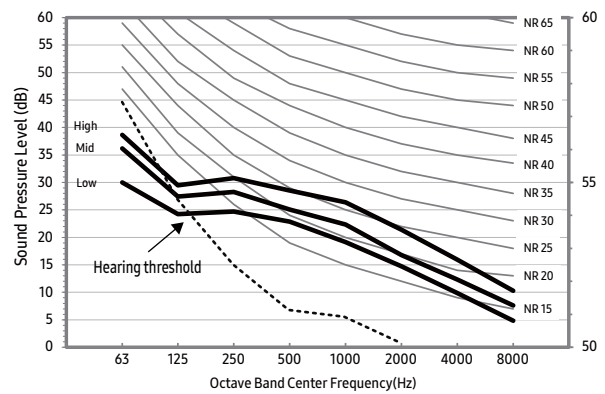

3) AM028KN*D*****

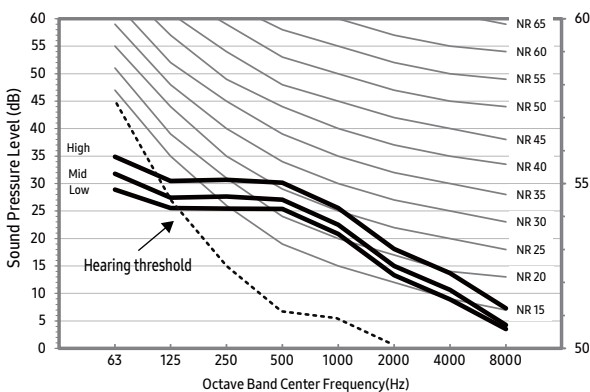

4) AM036KN*D*****

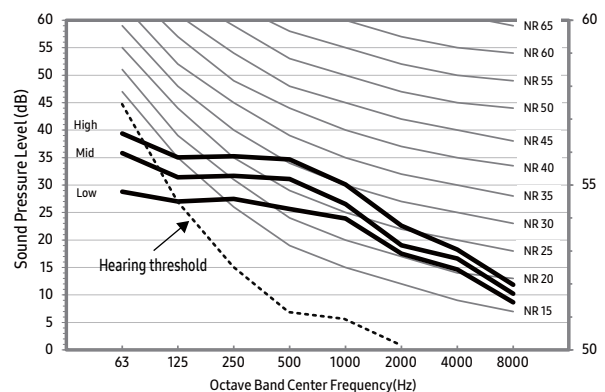

NOTE

- Specifications may be subject to change without prior notice
- Sound Pressure Level
 - Sound Pressure level is obtained in an anechoic room.
 - Sound Pressure level is a relative value, depending on the distance and acoustic environment.
 - Sound Pressure level may differ depending on operation condition.
 - dBA = A-weighted sound power level.
 - Reference acoustic pressure 0 dB = 20μPa

7. Sound Data

BORACAY

Sound Pressure Level

Unit: dB(A)

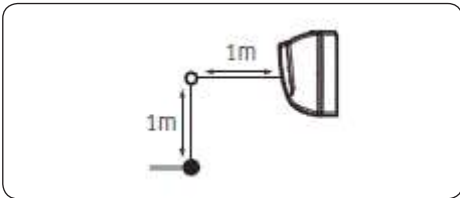

MODEL	Hi	MID	LOW
AM045KN*D*****	38	35	33
AM056KN*D*****	39	36	33
AM071KN*D*****	40	38	35

NR Curve

5) AM045KN*D*****

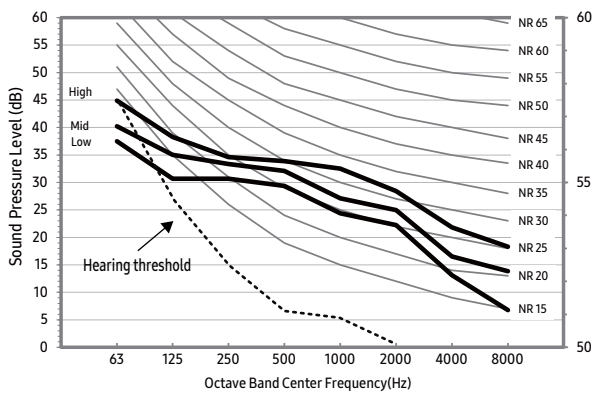

6) AM056KN*D*****

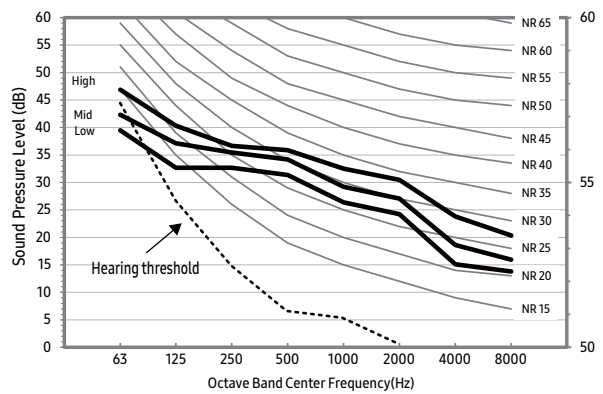

7) AM071KN*D*****

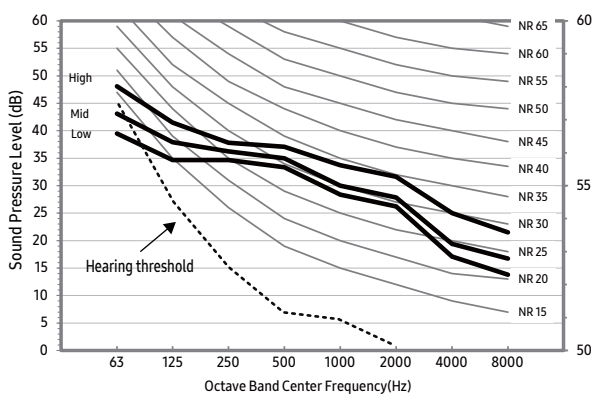

NOTE

- Specifications may be subject to change without prior notice
- Sound Pressure Level
 - Sound Pressure level is obtained in an anechoic room.
 - Sound Pressure level is a relative value, depending on the distance and acoustic environment.
 - Sound Pressure level may differ depending on operation condition.
 - dBA = A-weighted sound power level.
 - Reference acoustic pressure 0 dB = 20μPa

7. Sound Data

BORACAY

Sound Power Level

Unit: dB(A)

MODEL	Power
AM015KN*D*****	47
AM022KN*D*****	48
AM028KN*D*****	48
AM036KN*D*****	51

1) AM015KN*D*****

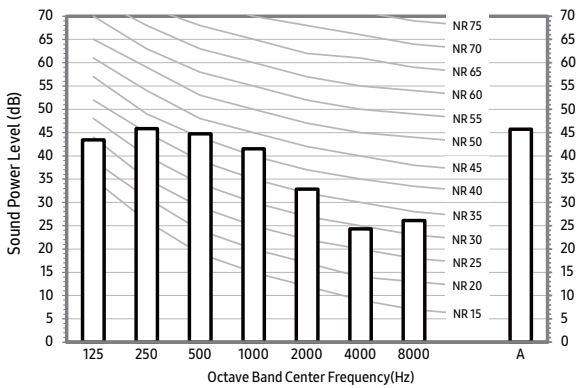

2) AM022KN*D*****

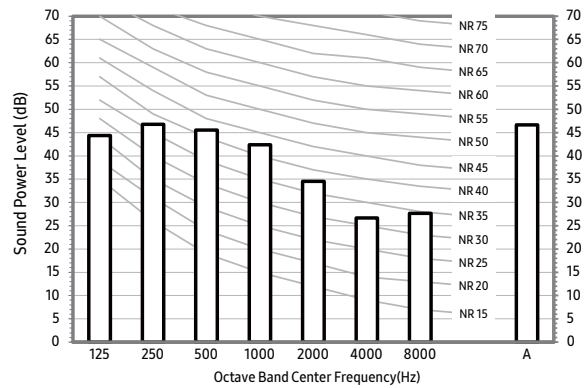

3) AM028KN*D*****

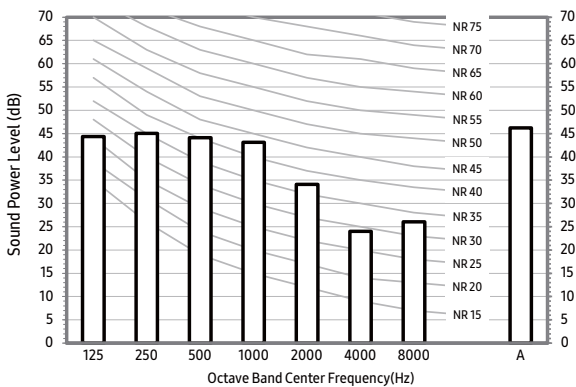

4) AM036KN*D*****

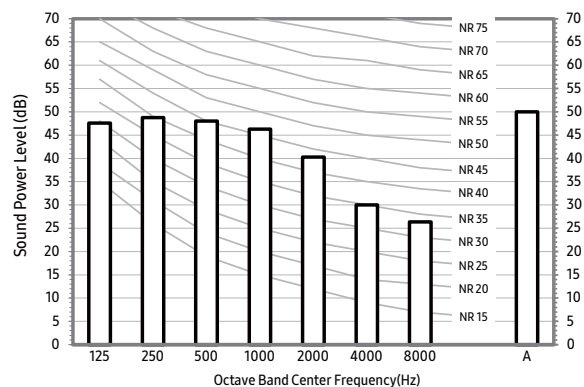

NOTE

- Specifications may be subject to change without prior notice.
 - Sound power level is an absolute value that a sound source generates.
 - dBA = A-weighted sound power level.
 - Reference power: 1pW.
 - Measured according to ISO 3741.

7. Sound Data

BORACAY

Sound Power Level

Unit: dB(A)

MODEL	Power
AM045KN*D*****	53
AM056KN*D*****	53
AM071KN*D*****	55

5) AM045KN*D*****

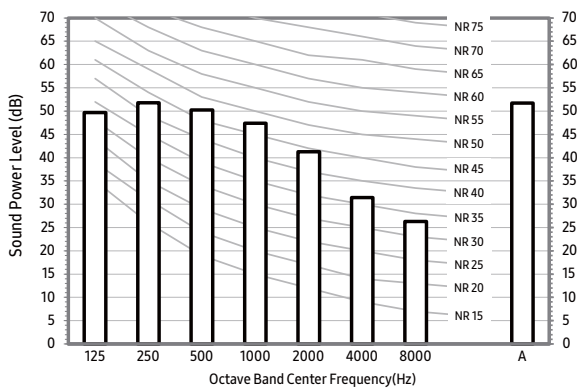

6) AM056KN*D*****

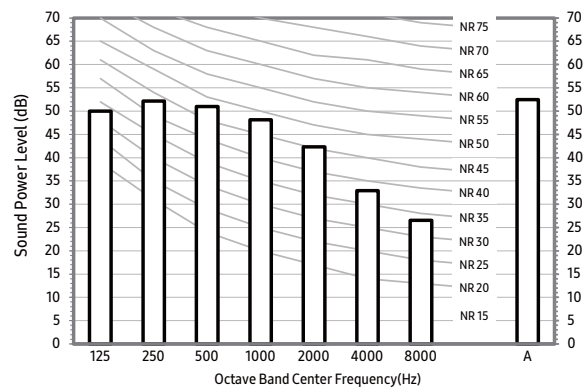

7) AM071KN*D*****

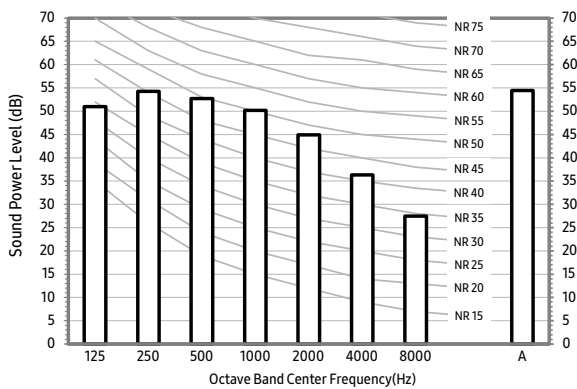

NOTE

- Specifications may be subject to change without prior notice.
 - Sound power level is an absolute value that a sound source generates.
 - dBA = A-weighted sound power level.
 - Reference power: 1pW.
 - Measured according to ISO 3741.

8. Temperature and Air Flow Distribution

BORACAY

AM015KN*D*****

Discharge angle : 26°

1) Cooling air velocity distribution

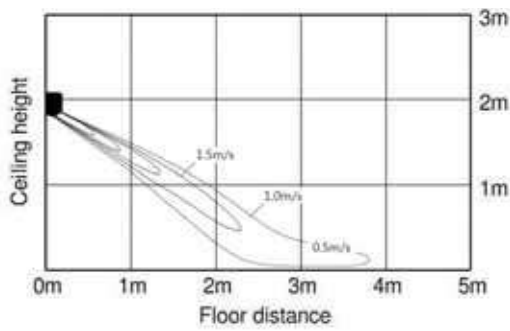

2) Cooling temperature distribution

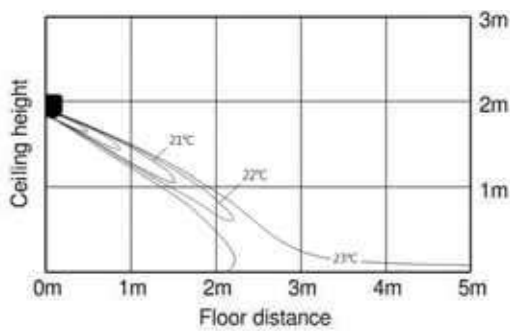

3) Heating air velocity distribution

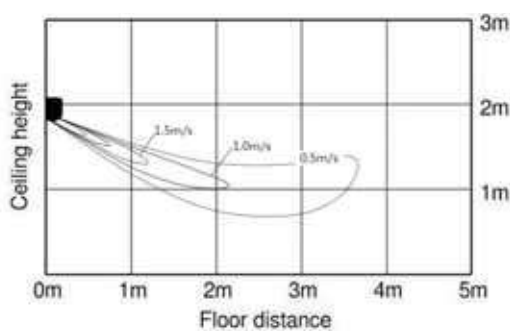

4) Heating temperature distribution

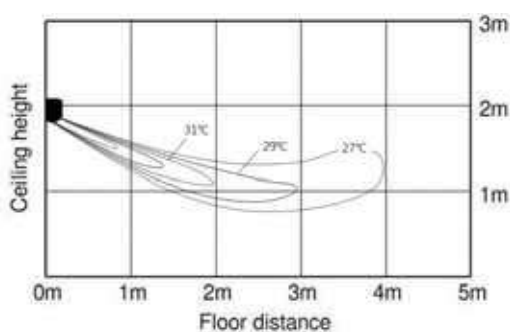

8. Temperature and Air Flow Distribution

BORACAY

AM022KN*D*****

Discharge angle : 26°

1) Cooling air velocity distribution

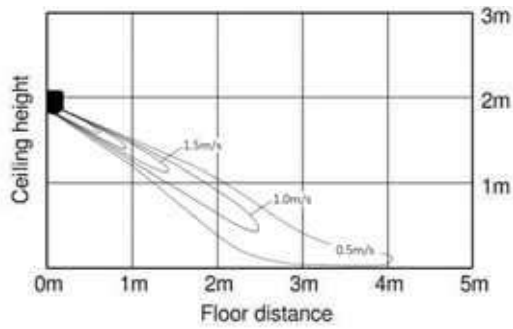

2) Cooling temperature distribution

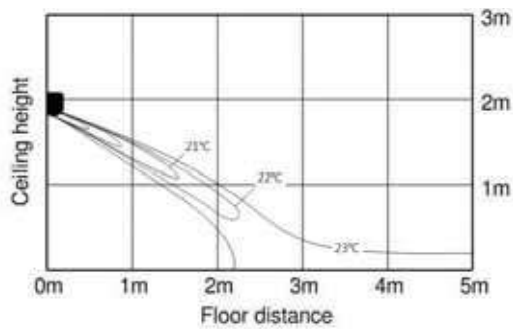

3) Heating air velocity distribution

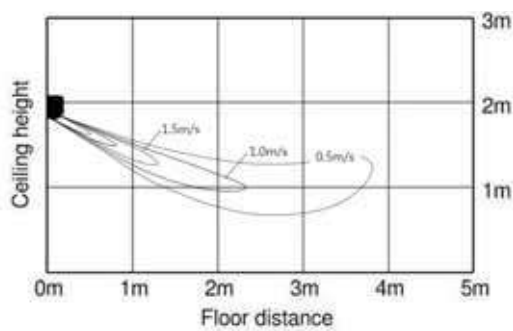

4) Heating temperature distribution

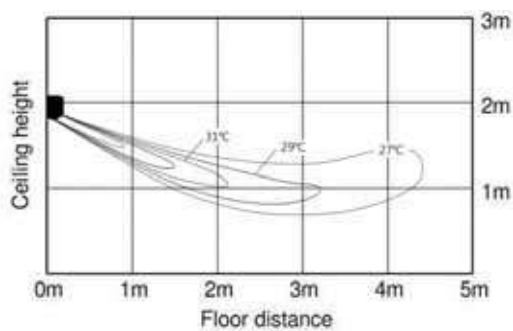

8. Temperature and Air Flow Distribution

BORACAY

AM028KN*D*****

Discharge angle : 26°

1) Cooling air velocity distribution

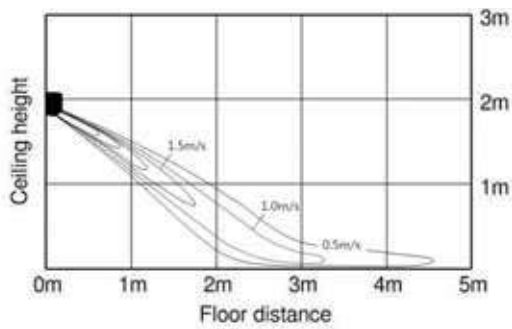

2) Cooling temperature distribution

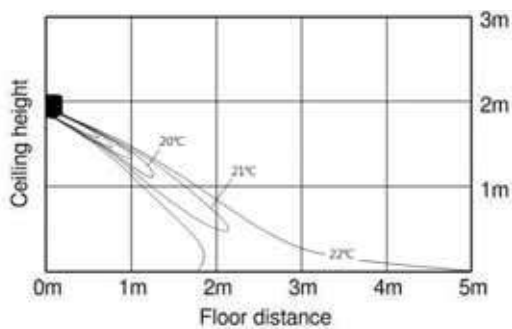

3) Heating air velocity distribution

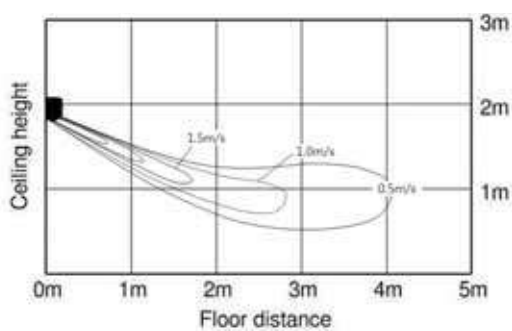

4) Heating temperature distribution

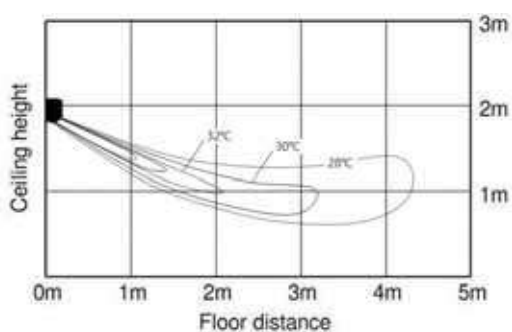

8. Temperature and Air Flow Distribution

BORACAY

AM036KN*D*****

Discharge angle : 26°

1) Cooling air velocity distribution

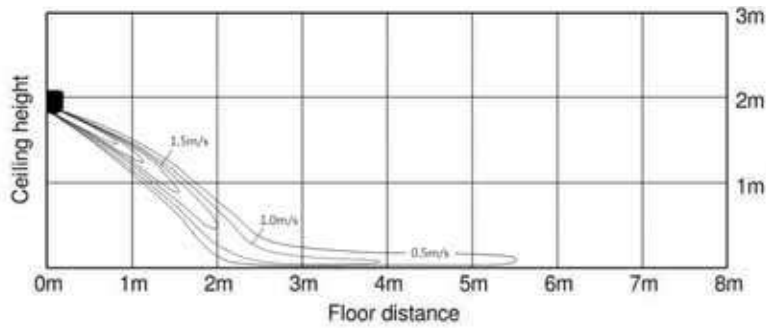

2) Cooling temperature distribution

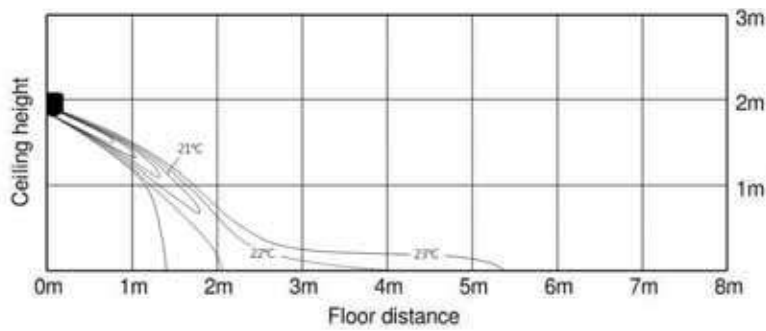

3) Heating air velocity distribution

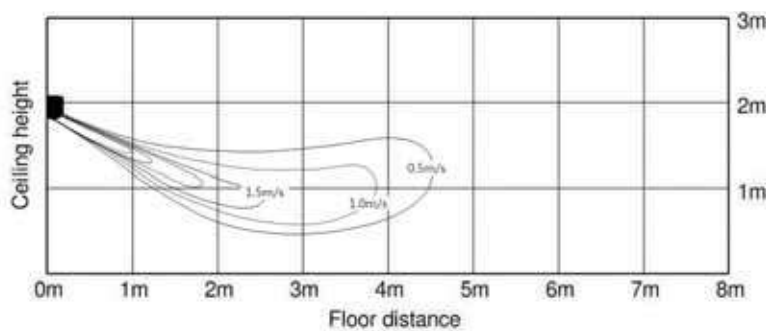

4) Heating temperature distribution

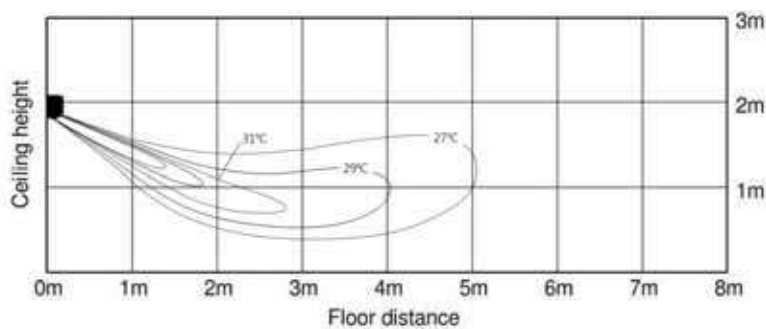

8. Temperature and Air Flow Distribution

BORACAY

AM045KN*D*****

Discharge angle : 26°

1) Cooling air velocity distribution

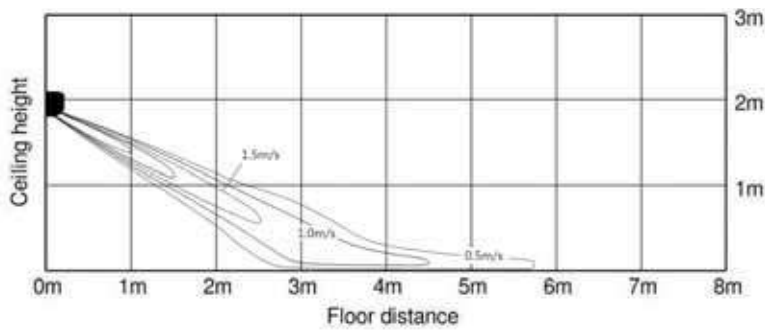

2) Cooling temperature distribution

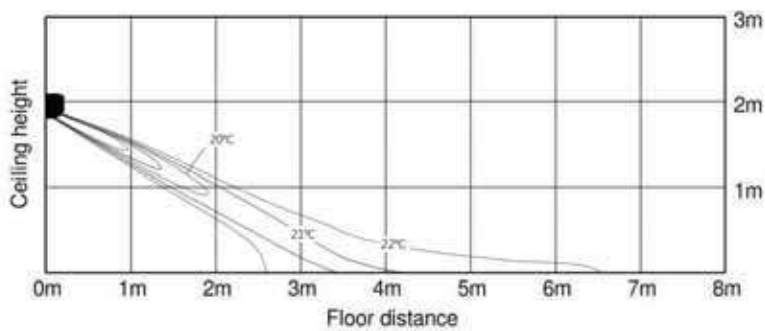

3) Heating air velocity distribution

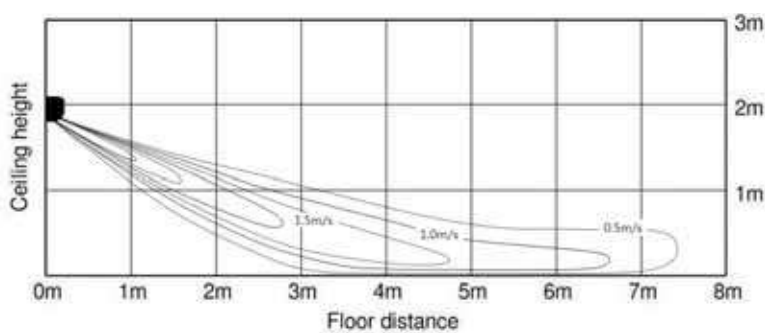

4) Heating temperature distribution

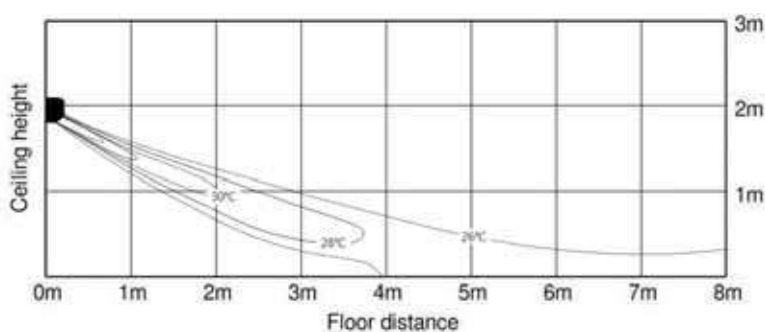

8. Temperature and Air Flow Distribution

BORACAY

AM056KN*D*****

Discharge angle : 26°

1) Cooling air velocity distribution

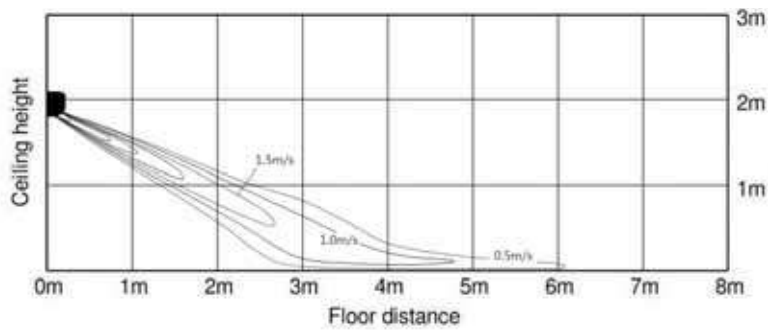

2) Cooling temperature distribution

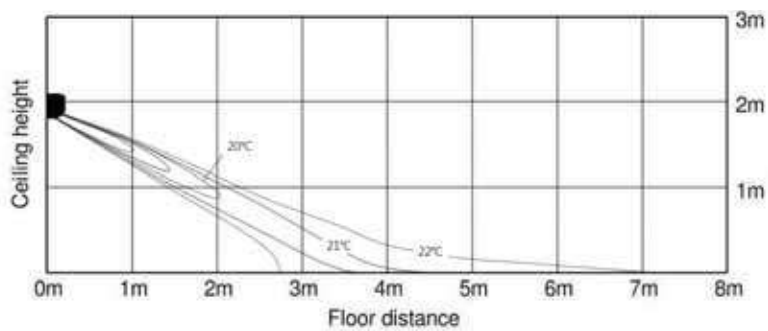

3) Heating air velocity distribution

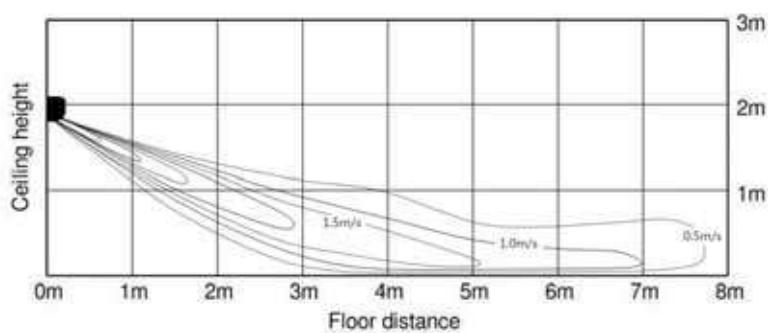

4) Heating temperature distribution

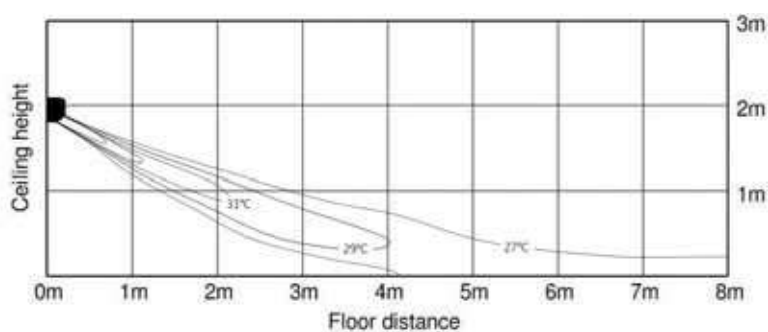

8. Temperature and Air Flow Distribution

BORACAY

AM071KN*D*****

Discharge angle : 26°

1) Cooling air velocity distribution

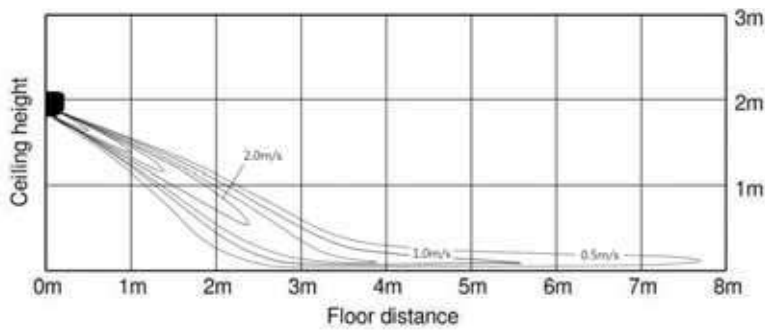

2) Cooling temperature distribution

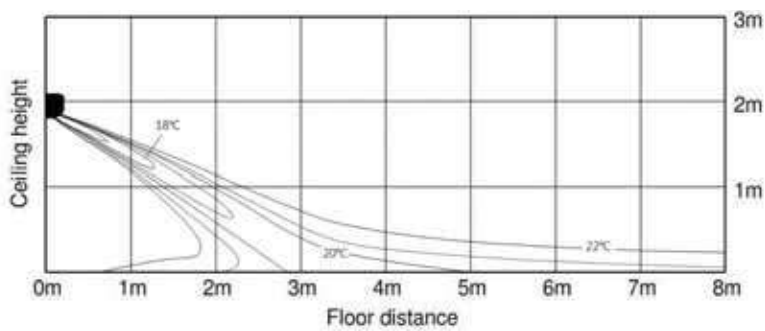

3) Heating air velocity distribution

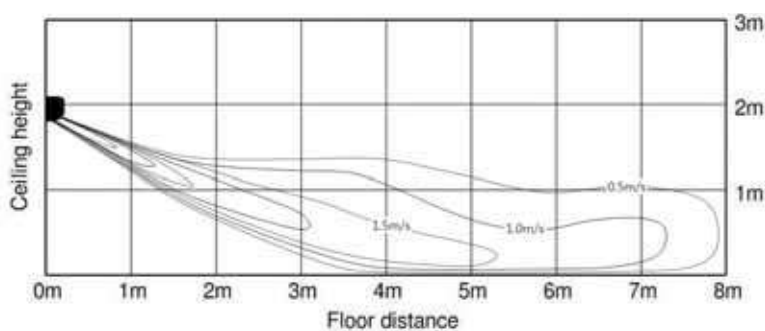

4) Heating temperature distribution

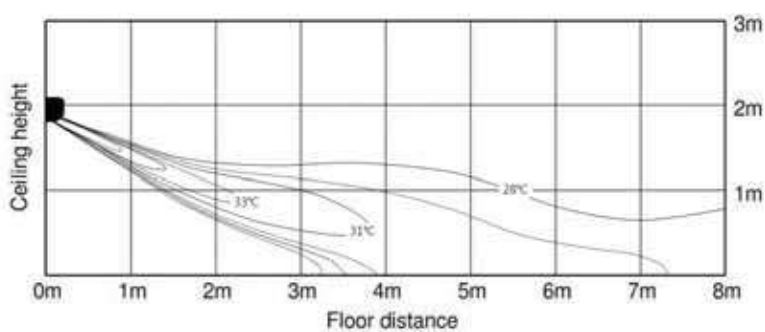

9. Piping Diagram

BORACAY

EEV included Model

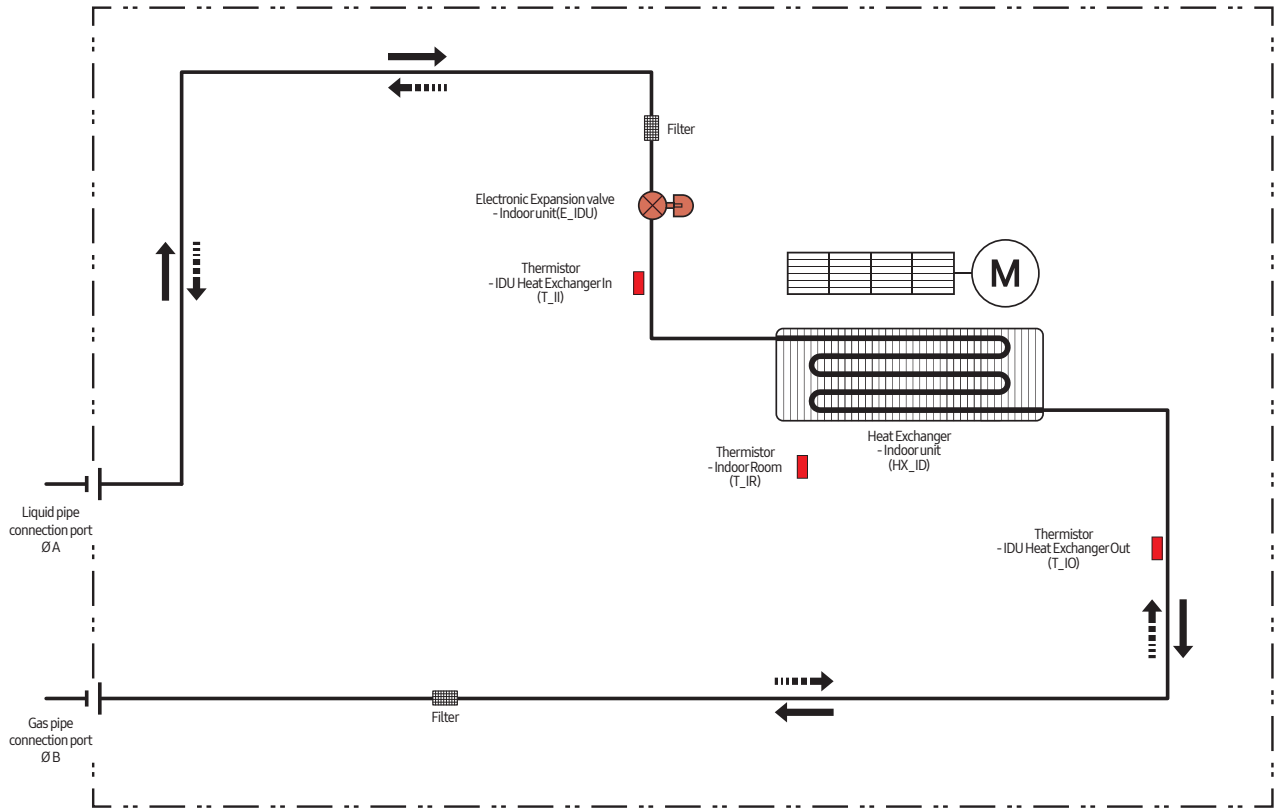

Refrigerant flow	
Cooling	Heating
→	→

MODEL	A	B
AM015KNQD*****	6.35	12.7
AM022KNQD*****		
AM028KNQD*****		
AM036KNQD*****		
AM045KNQD*****		
AM056KNQD*****		
AM071KNQD*****	9.52	15.88

9. Piping Diagram

BORACAY

EEV not included Model

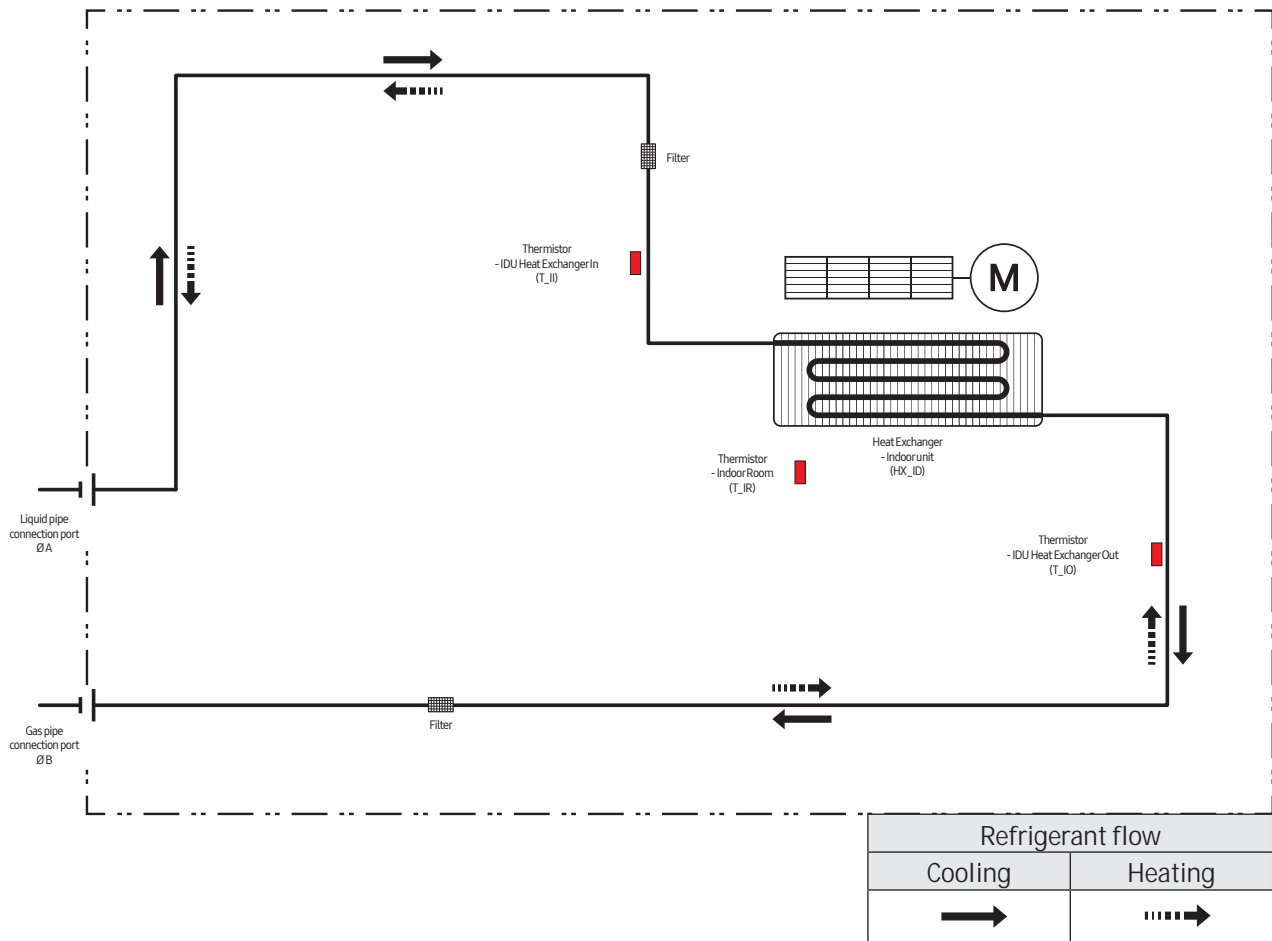

MODEL	A	B
AM015KNTD*****	6.35	12.7
AM022KNTD*****		
AM028KNTD*****		
AM036KNTD*****		
AM045KNTD*****		
AM056KNTD*****	9.52	15.88
AM071KNTD*****		

Ceiling

- 1 *Specifications*
- 2 *Capacity Table*
- 3 *Dimensional Drawing*
- 4 *Electrical Wiring Diagram*
- 5 *Sound Pressure Level*
- 6 *Temperature and air flow distribution*

1 Specifications

Ceiling

1) Technical specifications

Model				AM056FNCDEH***	AM071FNCDEH***	
Power Supply		Ø, #, V, Hz		1, 2, 220~240, 50	1, 2, 220~240, 50	
Mode ^{*1)}				HP/HR	HP/HR	
Performance	Capacity (Nominal)	Cooling ^{*2)}	kW	5.6	7.1	
			Btu/h	19,100	24,200	
		Heating ^{*3)}	kW	6.3	8.0	
			Btu/h	21,500	27,300	
Power	Power Input (Nominal)	Cooling ^{*2)}	W	72	80	
		Heating ^{*3)}	W	72	77	
	Current Input (Nominal)	Cooling ^{*2)}	A	0.33	0.35	
		Heating ^{*3)}	A	0.28	0.29	
Fan	Motor	Type	-	Sirocco Fan	Sirocco Fan	
		Output	W	60	120	
		Number of unit	EA	1	1	
	Air Flow Rate	H/M/L (UL)	CMM	14.00/13.00/12.00		18.00/16.50/15.00
			l/s	233.33/216.67/200.00		300.00/275.00/250.00
	External Pressure	Min / Std / Max	mmAq	-		-
			Pa	-		-
			WG	-		-
Option Code		-		013054-105000-203838-330010	013054-105000-204747-330010	
Piping Connections	Liquid Pipe	Ø, mm	6.35		9.52	
		Ø, inch	1/4		3/8	
	Gas Pipe	Ø, mm	12.70		15.88	
		Ø, inch	1/2		5/8	
Drain Pipe		Ø, mm	ID 18 HOSE		ID 18 HOSE	
Field Wiring	Power Source Wire	Below 20m / over 20m	mm ²	1.5 / 2.5		
	Transmission Cable		mm ²	0.75~1.5		
Refrigerant	Type		-	R410A		
	Control Method		-	EEV NOT INCLUDED		
Sound	Sound Pressure	High / Mid / Low ^{*4)}	dBA	40 / 37 / 34		
	Sound Power	Cooling	dBA	60		
Dimensions	Net Weight		kg	21.00		
	Shipping Weight		kg	25.50		
	Net Dimensions (W×H×D)		mm	1000 x 650 x 200		
	Shipping Dimensions (W×H×D)		mm	1080 x 730 x 300		
Panel Size	Panel model		-	-		
	Panel Net Weight		kg	-		
	Shipping Weight		kg	-		
	Net Dimensions (W×H×D)		mm	-		
	Shipping Dimensions (W×H×D)		mm	-		
Additional Accessories	Drain pump	Drain pump	- / Model	-		
		Max. lifting Height / Displacement	mm/liter/h	-		
	Air Filter		-	Long life filter		

* Specifications may be subject to change without prior notice for product improvement.

*1) Mode

- HP : Heat Pump, HR : Heat Recovery

*2) Nominal cooling capacities are based on;

- Indoor temperature : 27°C DB, 19°C WB

- Outdoor temperature : 35°C DB, 24°C WB, Equivalent refrigerant piping : 7.5m, Level differences : 0m

*3) Nominal heating capacities are based on;

- Indoor temperature : 20°C DB, 15°C WB

- Outdoor temperature : 7°C DB, 6°C WB, Equivalent refrigerant piping : 7.5m, Level differences : 0m

*4) Sound pressure was acquired in an anechoic room. Thus actual noise level may be different depending on the installation conditions.

*5) These products contain R410A which is fluorinated greenhouse gas.

* Heat Exchanger type : Fin & Tube (Fin : Al, Tube : Cu)

2 Capacity table

Ceiling

1) Cooling

TC : Total Capacity(kW), SHC : Sensible Heat Capacity(kW)

Capacity Index	Outdoor Air Temp. (°C, DB)	Indoor temperature													
		20(°C, DB)		23(°C, DB)		26(°C, DB)		27(°C, DB)		28(°C, DB)		30(°C, DB)		32(°C, DB)	
		14(°C, WB)		16(°C, WB)		18(°C, WB)		19(°C, WB)		20(°C, WB)		22(°C, WB)		24(°C, WB)	
	TC	SHC	TC	SHC	TC	SHC	TC	SHC	TC	SHC	TC	SHC	TC	SHC	
056	10	3.9	3.2	4.6	3.5	5.3	3.9	5.6	3.9	5.8	3.9	6.3	3.9	6.7	3.7
	12	3.9	3.2	4.6	3.5	5.3	3.9	5.6	3.9	5.8	3.9	6.3	3.9	6.7	3.7
	14	3.9	3.2	4.6	3.5	5.3	3.9	5.6	3.9	5.8	3.9	6.2	3.8	6.7	3.7
	16	3.9	3.2	4.6	3.5	5.3	3.9	5.6	3.9	5.8	3.9	6.2	3.8	6.6	3.6
	18	3.9	3.2	4.6	3.5	5.3	3.9	5.6	3.9	5.8	3.9	6.2	3.8	6.6	3.6
	20	3.9	3.2	4.6	3.5	5.3	3.9	5.6	3.9	5.8	3.9	6.2	3.8	6.6	3.6
	21	3.9	3.2	4.6	3.5	5.3	3.9	5.6	3.9	5.8	3.9	6.2	3.8	6.6	3.6
	23	3.9	3.2	4.6	3.5	5.3	3.9	5.6	3.9	5.8	3.9	6.2	3.8	6.6	3.6
	25	3.9	3.2	4.6	3.5	5.3	3.9	5.6	3.9	5.8	3.9	6.2	3.8	6.6	3.6
	27	3.9	3.2	4.6	3.5	5.3	3.9	5.6	3.9	5.8	3.9	6.2	3.8	6.6	3.6
	29	3.9	3.2	4.6	3.5	5.3	3.9	5.6	3.9	5.8	3.9	6.2	3.8	6.6	3.6
	31	3.9	3.2	4.6	3.5	5.3	3.9	5.6	3.9	5.8	3.9	6.2	3.8	6.6	3.6
	33	3.9	3.2	4.6	3.5	5.3	3.9	5.6	3.9	5.8	3.9	6.2	3.8	6.6	3.6
	35	3.9	3.2	4.6	3.5	5.3	3.9	5.6	3.9	5.8	3.9	6.2	3.8	6.6	3.6
	37	3.9	3.2	4.6	3.5	5.3	3.9	5.6	3.9	5.8	3.9	6.2	3.8	6.6	3.5
	39	3.9	3.2	4.6	3.5	5.3	3.9	5.6	3.9	5.8	3.9	6.2	3.8	6.6	3.4
42	3.9	3.2	4.6	3.5	5.3	3.9	5.5	3.8	5.7	3.9	6.1	3.7	6.4	3.3	
44	3.9	3.2	4.6	3.5	5.1	3.8	5.3	3.7	5.6	3.7	5.9	3.6	6.2	3.2	
46	3.9	3.2	4.6	3.5	5.0	3.7	5.2	3.6	5.4	3.6	5.7	3.5	6.0	3.1	
48	3.9	3.2	4.5	3.4	5.0	3.6	5.0	3.5	5.3	3.6	5.5	3.4	5.8	3.0	
071	10	4.9	4.0	5.8	4.5	6.7	4.8	7.1	5.0	7.4	5.0	8.0	5.1	8.5	4.8
	12	4.9	4.0	5.8	4.5	6.7	4.8	7.1	5.0	7.4	5.0	7.9	5.0	8.5	4.8
	14	4.9	4.0	5.8	4.5	6.7	4.8	7.1	5.0	7.4	5.0	7.9	5.0	8.5	4.8
	16	4.9	4.0	5.8	4.5	6.7	4.8	7.1	5.0	7.4	5.0	7.9	5.0	8.4	4.8
	18	4.9	4.0	5.8	4.5	6.7	4.8	7.1	5.0	7.4	5.0	7.9	5.0	8.4	4.8
	20	4.9	4.0	5.8	4.5	6.7	4.8	7.1	5.0	7.4	5.0	7.9	5.0	8.4	4.8
	21	4.9	4.0	5.8	4.5	6.7	4.8	7.1	5.0	7.4	5.0	7.9	5.0	8.4	4.8
	23	4.9	4.0	5.8	4.5	6.7	4.8	7.1	5.0	7.4	5.0	7.9	5.0	8.4	4.8
	25	4.9	4.0	5.8	4.5	6.7	4.8	7.1	5.0	7.4	5.0	7.9	5.0	8.4	4.8
	27	4.9	4.0	5.8	4.5	6.7	4.8	7.1	5.0	7.4	5.0	7.9	5.0	8.4	4.8
	29	4.9	4.0	5.8	4.5	6.7	4.8	7.1	5.0	7.4	5.0	7.9	5.0	8.4	4.8
	31	4.9	4.0	5.8	4.5	6.7	4.8	7.1	5.0	7.4	5.0	7.9	5.0	8.4	4.8
	33	4.9	4.0	5.8	4.5	6.7	4.8	7.1	5.0	7.4	5.0	7.9	5.0	8.4	4.8
	35	4.9	4.0	5.8	4.5	6.7	4.8	7.1	5.0	7.4	5.0	7.9	5.0	8.4	4.8
	37	4.9	4.0	5.8	4.5	6.7	4.8	7.1	5.0	7.3	4.9	7.8	4.9	8.2	4.7
	39	4.9	4.0	5.8	4.5	6.7	4.8	7.1	5.0	7.3	4.9	7.7	4.8	8.1	4.6
42	4.9	4.0	5.8	4.5	6.7	4.8	7.0	4.9	7.2	4.8	7.6	4.7	7.9	4.5	
44	4.9	4.0	5.8	4.5	6.5	4.6	6.8	4.8	7.0	4.7	7.3	4.5	7.6	4.3	
46	4.9	4.0	5.7	4.5	6.4	4.6	6.6	4.6	6.8	4.6	7.0	4.4	7.4	4.2	
48	4.8	3.9	5.7	4.4	6.3	4.5	6.4	4.5	6.7	4.5	6.8	4.3	7.2	4.1	

2 Capacity table

Ceiling

2) Heating

TC : Total Capacity(kW)

Capacity Index	Outdoor Air Temp. (°C)		Indoor temperature (°C,DB)				
			16(°C,DB)	18(°C,DB)	20(°C,DB)	22(°C,DB)	24(°C,DB)
	DB	WB	TC kW	TC kW	TC kW	TC kW	TC kW
056	-19.8	-20.0	3.9	3.8	3.8	3.7	3.7
	-18.8	-19.0	3.9	3.9	3.8	3.7	3.7
	-16.7	-17.0	4.0	4.0	3.9	3.8	3.8
	-14.7	-15.0	4.2	4.1	4.0	3.9	3.8
	-12.6	-13.0	4.4	4.3	4.2	4.1	4.0
	-10.5	-11.0	4.6	4.5	4.4	4.4	4.3
	-9.5	-10.0	4.7	4.6	4.6	4.5	4.4
	-8.5	-9.1	4.8	4.7	4.7	4.6	4.5
	-7.0	-7.6	4.9	4.8	4.8	4.7	4.5
	-5.0	-5.6	5.2	5.1	5.0	4.9	4.7
	-3.0	-3.7	5.4	5.3	5.3	5.1	4.9
	0.0	-0.7	5.7	5.6	5.5	5.3	5.0
	3.0	2.2	5.9	5.9	5.8	5.6	5.3
	5.0	4.1	6.2	6.1	6.0	5.7	5.3
	7.0	6.0	6.5	6.4	6.3	5.8	5.3
9.0	7.9	6.7	6.5	6.3	5.8	5.3	
11.0	9.8	6.9	6.6	6.3	5.8	5.3	
13.0	11.8	7.1	6.7	6.3	5.8	5.3	
15.0	13.7	7.3	6.8	6.3	5.8	5.3	
071	-19.8	-20.0	4.9	4.9	4.8	4.7	4.7
	-18.8	-19.0	5.0	4.9	4.8	4.7	4.7
	-16.7	-17.0	5.1	5.0	4.9	4.8	4.8
	-14.7	-15.0	5.3	5.2	5.1	4.9	4.8
	-12.6	-13.0	5.5	5.4	5.3	5.2	5.1
	-10.5	-11.0	5.8	5.7	5.6	5.5	5.5
	-9.5	-10.0	6.0	5.9	5.8	5.7	5.6
	-8.5	-9.1	6.1	6.0	5.9	5.8	5.7
	-7.0	-7.6	6.2	6.1	6.0	5.9	5.8
	-5.0	-5.6	6.5	6.5	6.4	6.2	6.0
	-3.0	-3.7	6.9	6.8	6.7	6.4	6.2
	0.0	-0.7	7.2	7.1	7.0	6.7	6.4
	3.0	2.2	7.6	7.5	7.3	7.1	6.8
	5.0	4.1	7.9	7.8	7.7	7.2	6.8
	7.0	6.0	8.2	8.1	8.0	7.4	6.8
9.0	7.9	8.5	8.2	8.0	7.4	6.8	
11.0	9.8	8.7	8.4	8.0	7.4	6.8	
13.0	11.8	9.0	8.5	8.0	7.4	6.8	
15.0	13.7	9.2	8.6	8.0	7.4	6.8	

3 Dimensional drawing

Ceiling

Unit:mm

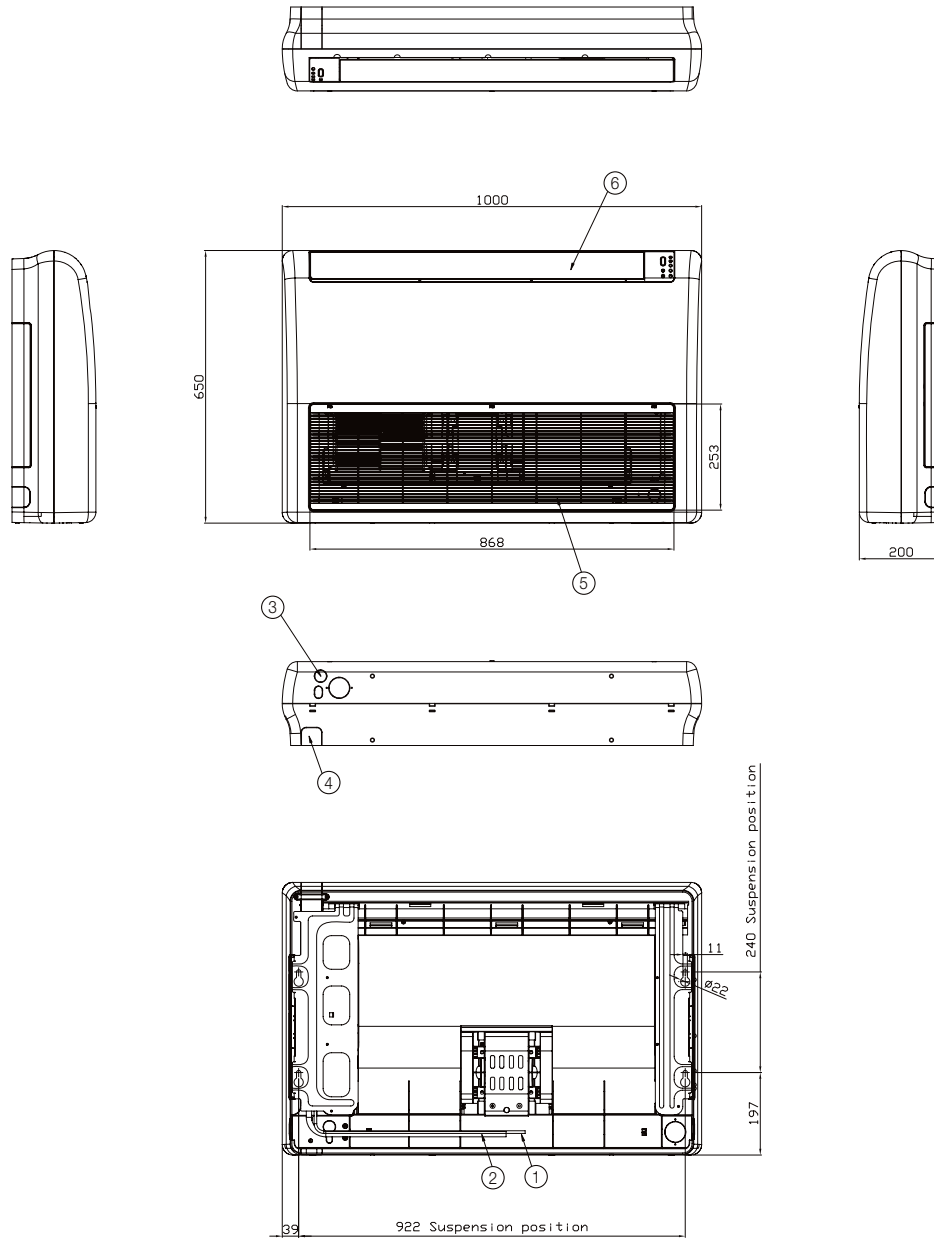

No.	Name	Description	
		5.6kW	7.1kW
①	Liquid pipe connection	Ø6.35 Flare	Ø9.52 Flare
②	Gas pipe connection	Ø12.70 Flare	Ø15.88 Flare
③	Drain pipe connection	ID18 Hose	
④	Conduit for power supply & communication wiring	-	
⑤	Air inlet grille	-	
⑥	Air outlet louver	-	

5 Sound pressure level

Ceiling

1) Operation sound level

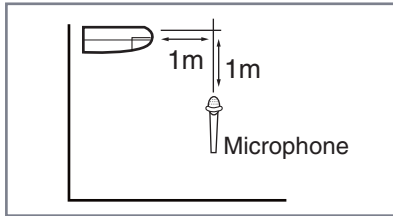

Unit : dB(A)

Model	High	Mid	Low
AM056FNCDEH***	40	37	34
AM071FNCDEH***	44	42	40

Note

Specifications may be subject to change without prior notice.
 Sound pressure level is obtained in an anechoic room.
 Sound pressure level is a relative value, depending on the distance and acoustic environment.
 Sound pressure level may differ depending on operation condition.
 dBA = A-weighted sound pressure level
 Reference acoustic pressure 0 dB= 20 uPa

2) NR curves

(1) AM056FNCDEH***

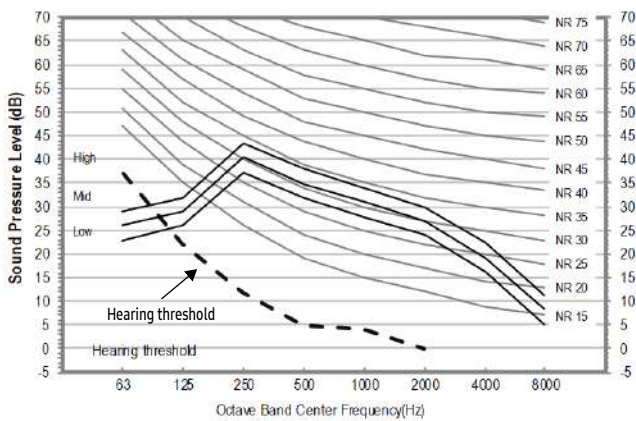

(2) AM071FNCDEH***

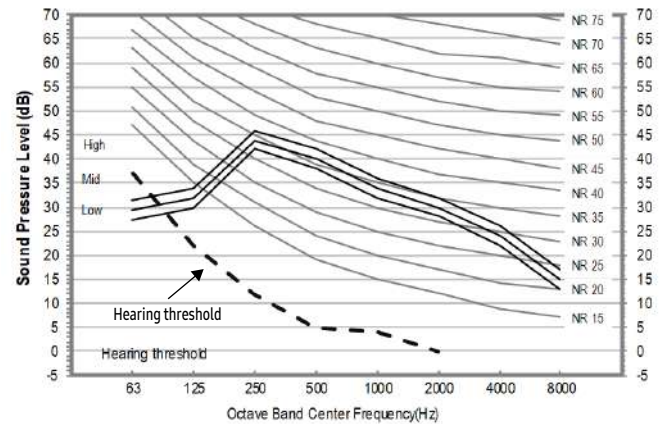

5 Sound Power Level

Ceiling

Unit: dB(A)

Model	Power
AM056FNCDEH/EU	60
AM071FNCDEH/EU	63

Note

- . Specifications may be subject to change without prior notice.
- . Sound power level is an absolute value that a sound source generates.
- . dBA = A-weighted sound power level.
- . Reference power : 1pW.
- . Measured according to ISO 3741

1) AM056FNCDEH/EU

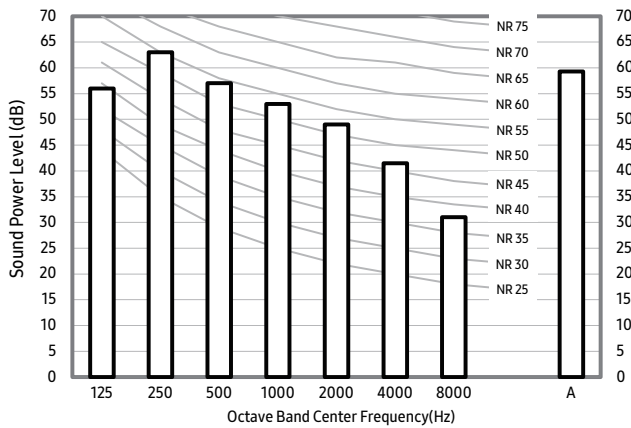

2) AM071FNCDEH/EU

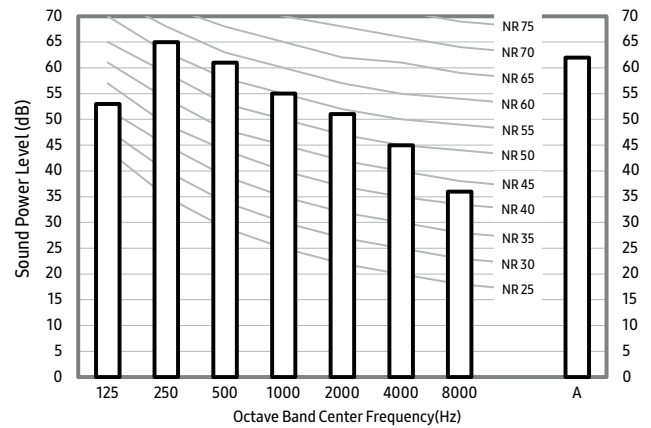

6 Temperature and air flow distribution

Ceiling

AM071FNCDEH/EU (Floor installation)

(1) Cooling air velocity distribution

Discharge angle : 36°

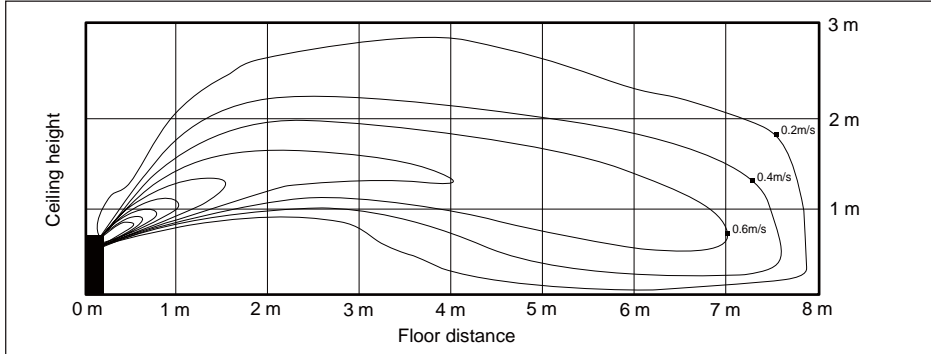

(2) Cooling temperature distribution

Discharge angle : 36°

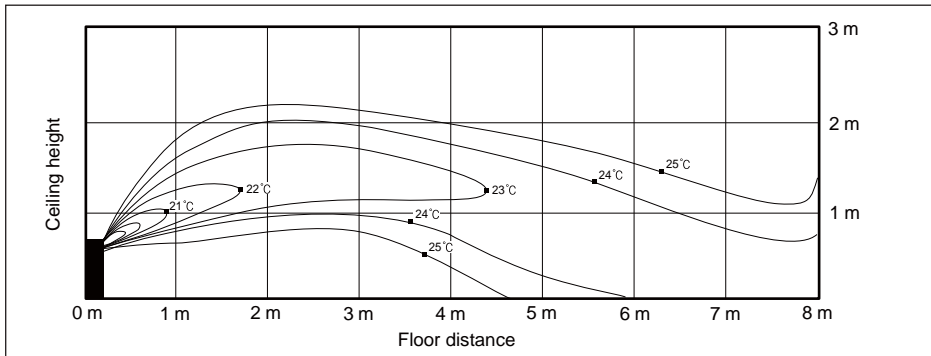

(3) Heating air velocity distribution

Discharge angle : 54°

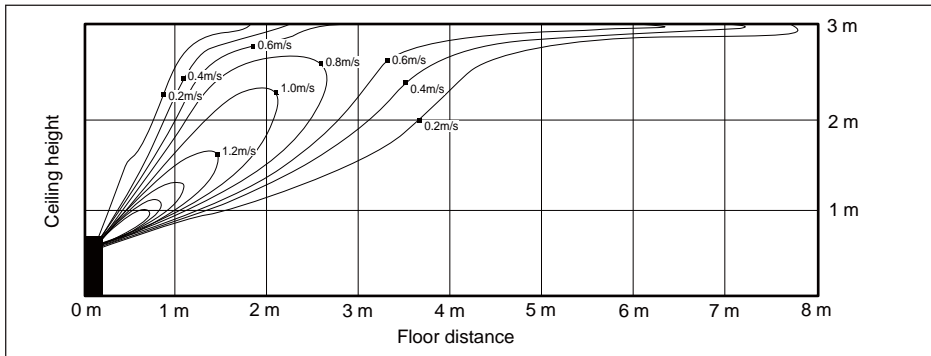

(4) Heating temperature distribution

Discharge angle : 54°

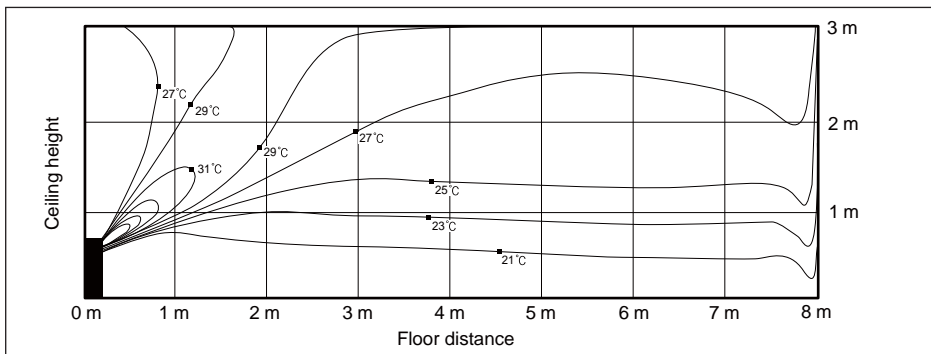

6 Temperature and air flow distribution

Ceiling

AM071FNCDEH/EU (Ceiling installation)

(1) Cooling air velocity distribution

Discharge angle : 36°

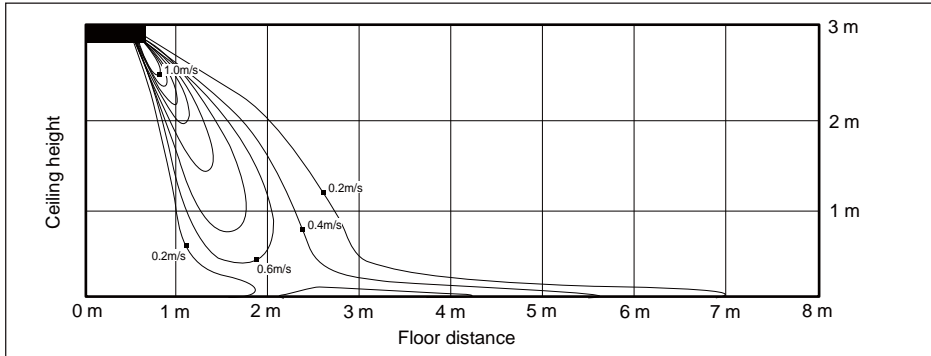

(2) Cooling temperature distribution

Discharge angle : 36°

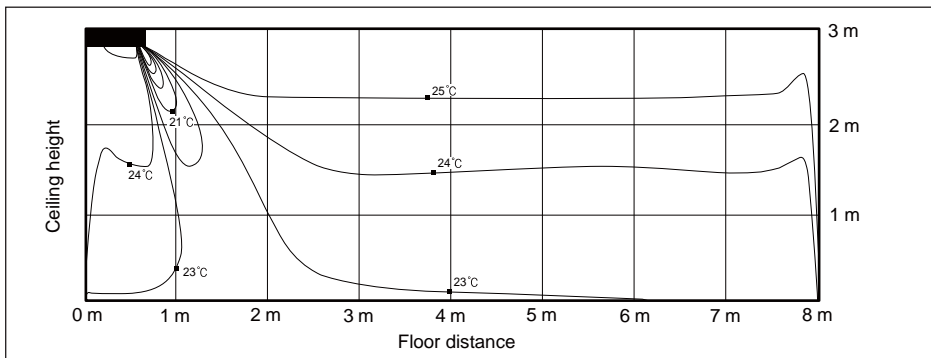

(3) Heating air velocity distribution

Discharge angle : 54°

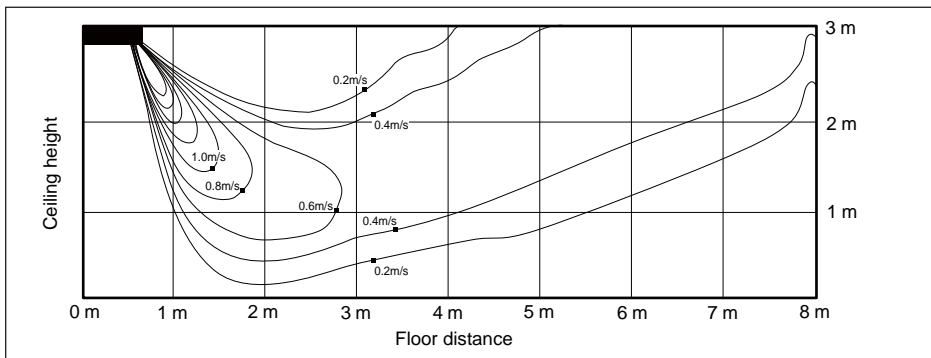

(4) Heating temperature distribution

Discharge angle : 54°

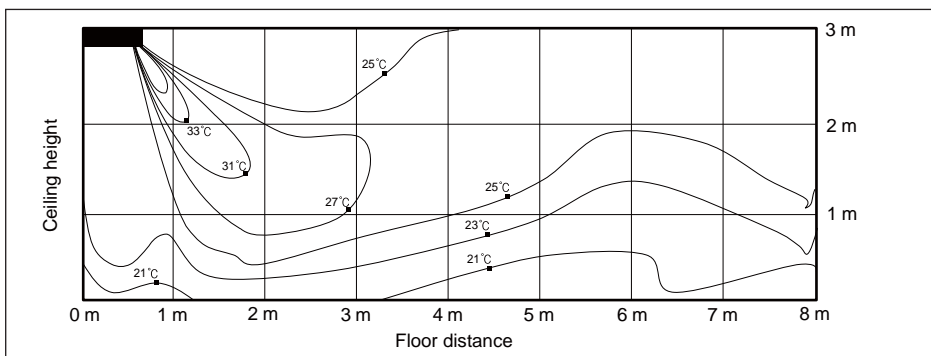

Big Ceiling

- 1 *Specifications*
- 2 *Capacity Table*
- 3 *Dimensional Drawing*
- 4 *Electrical Wiring Diagram*
- 5 *Sound Pressure Level*
- 6 *Sound Power Level*
- 7 *Temperature and air flow distribution*

1 Specifications

Big Ceiling

Type			Ceiling		Ceiling	
Model			AM112JNC DKH/EU		AM140JNC DKH/EU	
Power Supply			Ø, #, V, Hz	1,2,220-240,50/60		
Mode			-	HP/HR		
Performance	Capacity (Nominal)	Cooling	kW	11.20		
			Btu/h	38,200		
		Heating	kW	12.50		
			Btu/h	42,700		
Power	Power Input (Nominal)	Cooling	W	92.00		
		Heating		80.00		
	Current Input (Nominal)	Cooling	A	0.94		
		Heating		0.83		
Fan	Motor	Type	-	Sirocco Fan		
		Output x n	w	260 x 1		
	Air Flow Rate	H/M/L (UL)	CMM	29.30 / 23.90 / 18.50		
			l/s	488.33 / 398.33 / 308.33		
	External Pressure	Min/Std/Max	mmAq	-		
Pa			-			
Piping Connections	Liquid Pipe	Ø, mm	9.52			
		Ø, inch	3/8"			
	Gas Pipe	Ø, mm	15.88			
		Ø, inch	5/8"			
	Drain Pipe	Ø, mm	VP25 (OD 25, ID 20)			
Field Wiring	Power Source Wire	mm ²	1.5 - 2.5			
	Transmission Cable	mm ²	0.75 - 1.50			
Refrigerant	Type	-	R410A			
	Control Method	-	EEV INCLUDED			
Sound	Pressure	High / Mid / Low	dB(A)	45 / 41 / 37		
	Power	Cooling		61		
Dimension	Net Weight		kg	33.5		
	Shipping Weight		kg	39.5		
	Net Dimensions (WxHxD)		mm	1,350 x 235 x 675		
	Shipping Dimensions (WxHxD)		mm	1,439 x 758 x 321		
Panel Size	Panel model		-	-		
	Panel Net Weight		kg	-		
	Shipping Weight		kg	-		
	Net Dimensions (WxHxD)		mm	-		
	Shipping Dimensions (WxHxD)		mm	-		
Additional Accessories	Drain Pump	Drain Pump	- / Model	-		
		Max. lifting Height / Displacement	mm/liter/h	-		
	Air Filter		-	-		

* Specifications may be subject to change without prior notice for product improvement.

*1) Mode

- HP : Heat Pump, HR : Heat Recovery

*2) Nominal cooling capacities are based on;

- Indoor temperature : 27°C DB, 19°C WB

- Outdoor temperature : 35°C DB, 24°C WB, Equivalent refrigerant piping : 7.5m, Level differences : 0m

*3) Nominal heating capacities are based on;

- Indoor temperature : 20°C DB, 15°C WB

- Outdoor temperature : 7°C DB, 6°C WB, Equivalent refrigerant piping : 7.5m, Level differences : 0m

*4) Sound pressure was acquired in an anechoic room. Thus actual noise level may be different depending on the installation conditions.

*5) These products contain R410A which have a global warming potential (GWP) greater than 150.

* Heat Exchanger type : Fin & Tube (Fin : Al, Tube : Cu)

2 Capacity table

Big Ceiling

Cooling

TC : Total Capacity, SHC : Sensible Heat Capacity

Capacity Index	Outdoor Air Temp. (°C, DB)	Indoor temperature													
		20(°C, DB)		23(°C, DB)		26(°C, DB)		27(°C, DB)		28(°C, DB)		30(°C, DB)		32(°C, DB)	
		14(°C, WB)		16(°C, WB)		18(°C, WB)		19(°C, WB)		20(°C, WB)		22(°C, WB)		24(°C, WB)	
	TC	SHC	TC	SHC	TC	SHC	TC	SHC	TC	SHC	TC	SHC	TC	SHC	
112	10	7.7	6.4	9.1	7.1	10.5	7.8	11.2	7.9	11.6	7.9	12.5	7.9	13.4	7.9
	12	7.7	6.4	9.1	7.1	10.5	7.8	11.2	7.9	11.6	7.9	12.5	7.9	13.4	7.9
	14	7.7	6.4	9.1	7.1	10.5	7.8	11.2	7.9	11.6	7.9	12.5	7.9	13.3	7.8
	16	7.7	6.4	9.1	7.1	10.5	7.8	11.2	7.9	11.6	7.9	12.5	7.9	13.3	7.8
	18	7.7	6.4	9.1	7.1	10.5	7.8	11.2	7.9	11.6	7.9	12.4	7.9	13.2	7.7
	20	7.7	6.4	9.1	7.1	10.5	7.8	11.2	7.9	11.6	7.9	12.4	7.9	13.2	7.7
	21	7.7	6.4	9.1	7.1	10.5	7.8	11.2	7.9	11.6	7.9	12.4	7.9	13.2	7.7
	23	7.7	6.4	9.1	7.1	10.5	7.8	11.2	7.9	11.6	7.9	12.4	7.9	13.2	7.7
	25	7.7	6.4	9.1	7.1	10.5	7.8	11.2	7.9	11.6	7.9	12.4	7.9	13.2	7.7
	27	7.7	6.4	9.1	7.1	10.5	7.8	11.2	7.9	11.6	7.9	12.4	7.9	13.2	7.7
	29	7.7	6.4	9.1	7.1	10.5	7.8	11.2	7.9	11.6	7.9	12.4	7.9	13.2	7.7
	31	7.7	6.4	9.1	7.1	10.5	7.8	11.2	7.9	11.6	7.9	12.4	7.9	13.2	7.7
	33	7.7	6.3	9.1	7.0	10.5	7.8	11.2	7.9	11.6	7.9	12.4	7.9	13.2	7.7
	35	7.7	6.3	9.1	7.0	10.5	7.8	11.2	7.9	11.6	7.9	12.4	7.9	13.2	7.7
	37	7.7	6.3	9.1	7.0	10.5	7.8	11.2	7.9	11.6	7.9	12.3	7.8	13.0	7.6
	39	7.7	6.3	9.1	7.0	10.5	7.8	11.2	8.0	11.5	7.8	12.1	7.7	12.7	7.5
	42	7.7	6.3	9.1	7.0	10.4	7.7	11.1	7.9	11.4	7.7	11.9	7.6	12.4	7.3
44	7.7	6.3	9.1	7.0	10.1	7.5	10.7	7.6	11.0	7.5	11.4	7.3	12.0	7.1	
46	7.7	6.3	9.0	6.9	10.0	7.4	10.4	7.4	10.7	7.3	11.0	7.0	11.6	6.9	
48	7.6	6.2	8.9	6.8	9.8	7.3	10.1	7.2	10.5	7.1	10.7	6.8	11.2	6.6	
140	10	9.7	7.7	11.4	8.5	13.1	9.4	14.0	9.6	14.6	9.6	15.7	9.5	16.8	9.7
	12	9.7	7.7	11.4	8.5	13.1	9.4	14.0	9.6	14.5	9.6	15.6	9.6	16.7	9.6
	14	9.7	7.7	11.4	8.5	13.1	9.4	14.0	9.6	14.5	9.6	15.6	9.6	16.7	9.6
	16	9.7	7.7	11.4	8.5	13.1	9.4	14.0	9.6	14.5	9.6	15.6	9.6	16.6	9.5
	18	9.7	7.7	11.4	8.5	13.1	9.4	14.0	9.6	14.5	9.6	15.5	9.5	16.6	9.5
	20	9.7	7.7	11.4	8.5	13.1	9.4	14.0	9.6	14.5	9.6	15.5	9.5	16.5	9.4
	21	9.7	7.7	11.4	8.5	13.1	9.4	14.0	9.6	14.5	9.6	15.5	9.5	16.5	9.4
	23	9.7	7.7	11.4	8.5	13.1	9.4	14.0	9.6	14.5	9.6	15.5	9.5	16.5	9.4
	25	9.7	7.7	11.4	8.5	13.1	9.4	14.0	9.6	14.5	9.6	15.5	9.5	16.5	9.4
	27	9.7	7.7	11.4	8.5	13.1	9.4	14.0	9.6	14.5	9.6	15.5	9.5	16.5	9.4
	29	9.7	7.7	11.4	8.5	13.1	9.4	14.0	9.6	14.5	9.6	15.5	9.5	16.5	9.4
	31	9.7	7.7	11.4	8.5	13.1	9.4	14.0	9.6	14.5	9.6	15.5	9.5	16.5	9.4
	33	9.7	7.7	11.4	8.5	13.1	9.4	14.0	9.6	14.5	9.6	15.5	9.5	16.5	9.4
	35	9.7	7.7	11.4	8.5	13.1	9.4	14.0	9.6	14.5	9.6	15.5	9.5	16.5	9.4
	37	9.7	7.7	11.4	8.5	13.1	9.4	14.0	9.6	14.5	9.6	15.4	9.4	16.3	9.2
	39	9.7	7.7	11.4	8.5	13.1	9.4	14.0	9.6	14.4	9.4	15.1	9.3	15.9	9.0
	42	9.7	7.7	11.4	8.5	13.0	9.3	13.8	9.5	14.2	9.3	14.8	9.1	15.5	8.8
44	9.7	7.7	11.4	8.5	12.7	9.1	13.4	9.2	13.8	9.0	14.2	8.8	15.0	8.5	
46	9.7	7.7	11.3	8.4	12.4	8.9	12.9	8.9	13.4	8.8	13.8	8.5	14.6	8.2	
48	9.6	7.6	11.1	8.3	12.2	8.8	12.6	8.6	13.1	8.6	13.4	8.2	14.1	8.0	

2 Capacity table

Big Ceiling

Heating

TC : Total Capacity

Capacity Index	Outdoor Air Temp. (°C)		Indoor temperature (°C,DB)				
			16(°C,DB)	18(°C,DB)	20(°C,DB)	22(°C,DB)	24(°C,DB)
	DB	WB	TC kW	TC kW	TC kW	TC kW	TC kW
112	-19.8	-20.0	7.4	7.4	7.3	7.3	7.3
	-18.8	-19.0	7.6	7.6	7.4	7.4	7.3
	-16.7	-17.0	8.1	7.8	7.6	7.5	7.4
	-14.7	-15.0	8.4	8.2	8.0	7.8	7.6
	-12.6	-13.0	8.7	8.5	8.3	8.1	8.0
	-10.5	-11.0	9.1	8.9	8.8	8.7	8.6
	-9.5	-10.0	9.3	9.1	9.0	8.9	8.8
	-8.5	-9.1	9.5	9.3	9.2	9.0	8.9
	-7.0	-7.6	9.7	9.6	9.4	9.2	9.0
	-5.0	-5.6	10.2	10.1	9.9	9.6	9.3
	-3.0	-3.7	10.7	10.6	10.5	10.1	9.7
	0.0	-0.7	11.3	11.1	11.1	10.5	10.0
	3.0	2.2	11.8	11.6	11.5	11.0	10.6
	5.0	4.1	12.3	12.2	12.0	11.3	10.6
	7.0	6.0	12.9	12.7	12.5	11.5	10.6
9.0	7.9	13.3	12.9	12.5	11.5	10.6	
11.0	9.8	13.7	13.1	12.5	11.5	10.6	
13.0	11.8	14.0	13.3	12.5	11.5	10.6	
15.0	13.7	14.4	13.5	12.5	11.5	10.6	
140	-19.8	-20.0	9.5	9.5	9.4	9.4	9.3
	-18.8	-19.0	9.7	9.7	9.5	9.5	9.3
	-16.7	-17.0	10.2	10.0	9.7	9.6	9.4
	-14.7	-15.0	10.8	10.5	10.2	9.9	9.6
	-12.6	-13.0	11.1	10.9	10.7	10.4	10.1
	-10.5	-11.0	11.6	11.5	11.3	11.1	10.9
	-9.5	-10.0	11.8	11.7	11.5	11.4	11.2
	-8.5	-9.1	12.1	11.9	11.8	11.6	11.3
	-7.0	-7.6	12.4	12.2	12.1	11.8	11.5
	-5.0	-5.6	13.1	12.9	12.7	12.3	12.0
	-3.0	-3.7	13.8	13.6	13.4	12.9	12.4
	0.0	-0.7	14.4	14.2	14.0	13.4	12.8
	3.0	2.2	15.1	14.9	14.7	14.1	13.5
	5.0	4.1	15.8	15.6	15.3	14.4	13.5
	7.0	6.0	16.5	16.2	16.0	14.8	13.5
9.0	7.9	17.0	16.5	16.0	14.8	13.5	
11.0	9.8	17.5	16.7	16.0	14.8	13.5	
13.0	11.8	18.0	17.0	16.0	14.8	13.5	
15.0	13.7	18.5	17.2	16.0	14.8	13.5	

3 Dimensional drawing

Big Ceiling

AM112JNCDKH/EU

Units : mm/inches

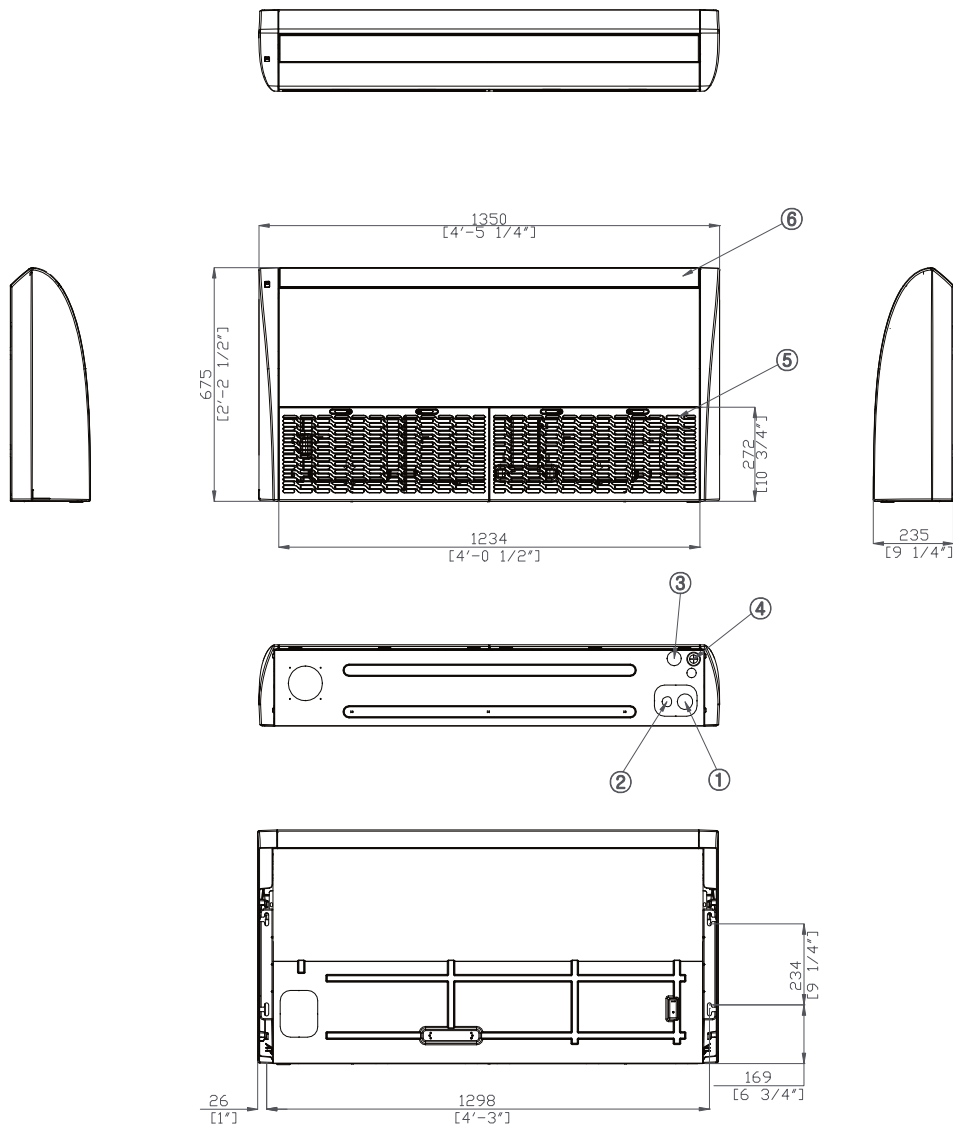

Table of descriptions

1	Refrigerant gas pipe	7	
2	Refrigerant liquid pipe	8	
3	Condensate drain	9	
4	Power&Comm. wiring conduits	10	
5	Air Inlet grille	11	
6	Air Outlet grille	12	

3 Dimensional drawing

Big Ceiling

AM140JNCDKH/EU

Units : mm/inches

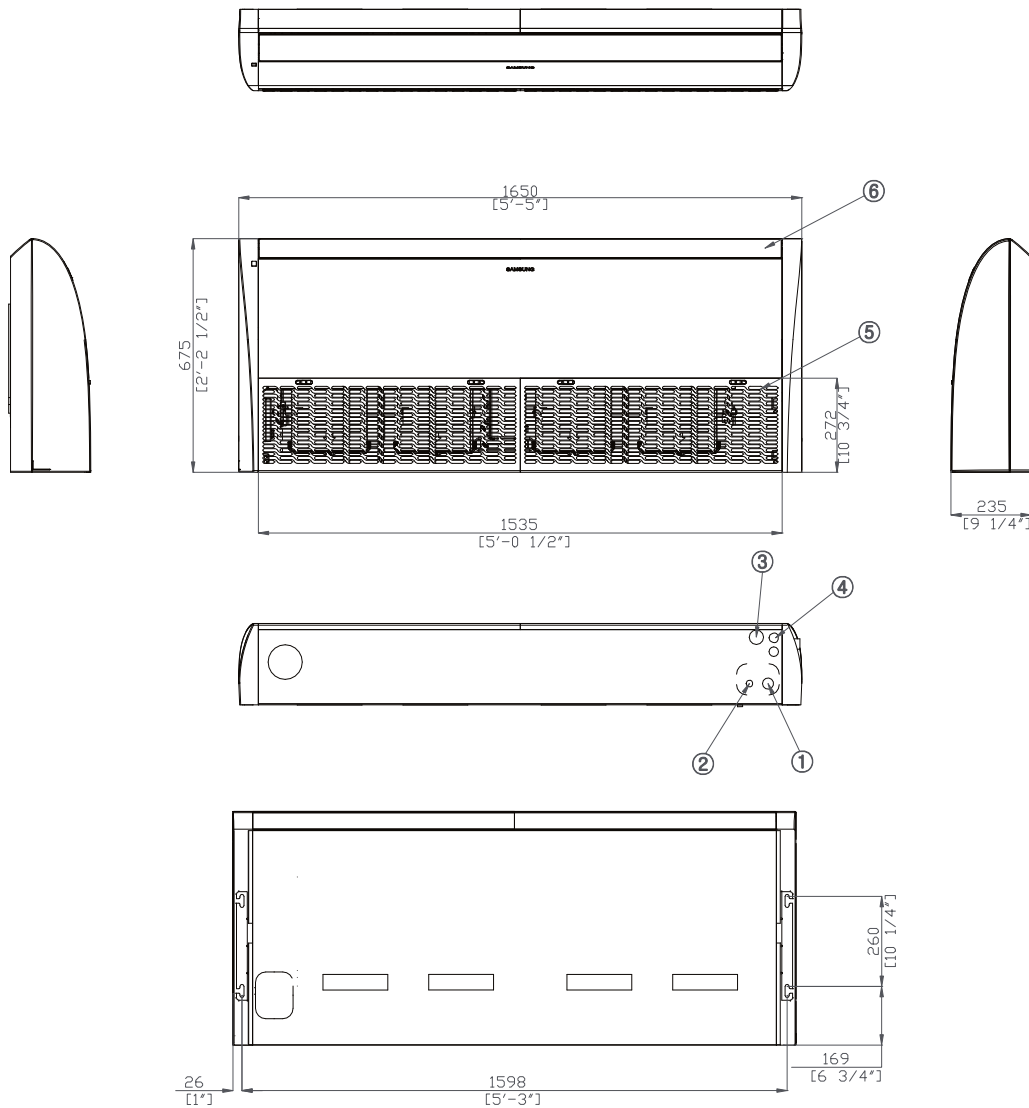

Table of descriptions

1	Refrigerant gas pipe	7	
2	Refrigerant liquid pipe	8	
3	Condensate drain	9	
4	Power&Comm. wiring conduits	10	
5	Air Inlet grille	11	
6	Air Outlet grille	12	

4 Electrical Wiring Diagram

Big Ceiling

AM112/140JNCDKH/EU

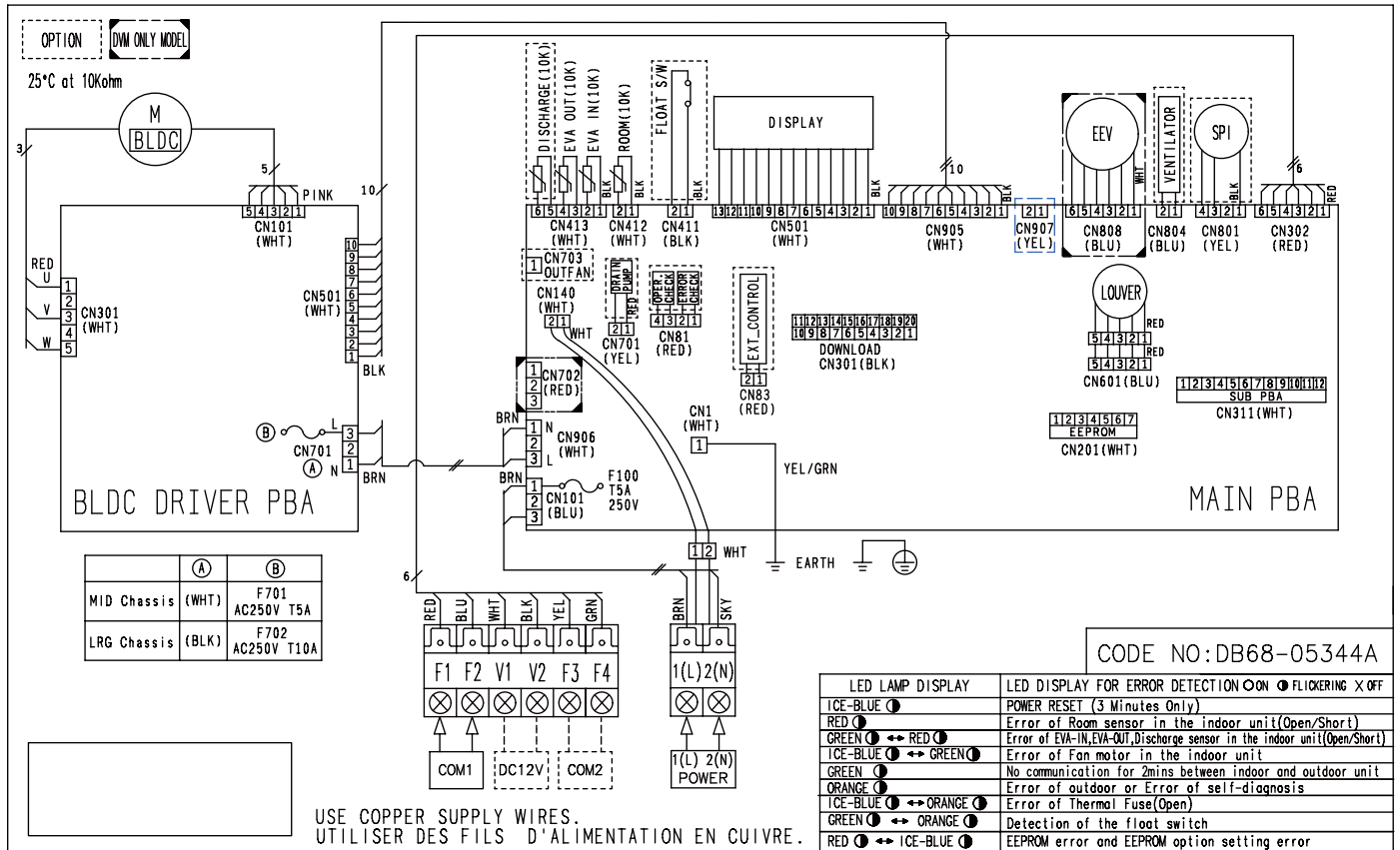

NOTE

1. This wiring diagram applies only to the indoor unit.
2. Symbols show as follow;
BLK : black, RED : red, BLU : blue, WHT:white, YEL : yellow, BRN : brown, SKY : sky-blue, GRN : green
3. For connection wiring indoor-outdoor transmission F1-F2, indoor-wired remotecontroller transmission F3-F4.
4. : Protective earth(screw), : Connector, n : The wire quantity

5 Sound pressure level

Big Ceiling

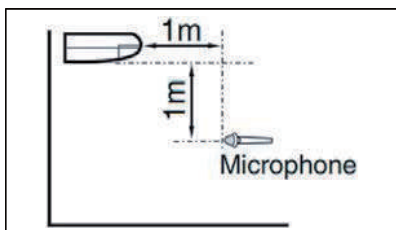

Unit: dB(A)

Model	High	Low
AM112JNC DKH/EU	45	37
AM140JNC DKH/EU	46	38

Note

Specifications may be subject to change without prior notice.
 Sound pressure level is obtained in an anechoic room.
 Sound pressure level is a relative value, depending on the distance and acoustic environment.
 Sound pressure level may differ depending on operation condition.
 dBA = A-weighted sound pressure level
 Reference acoustic pressure 0 dB= 20 uPa

NR curve

1) AM112JNC DKH/EU

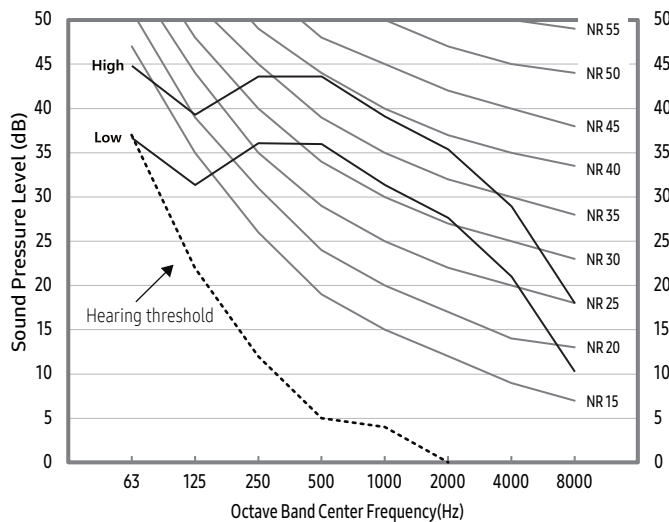

2) AM140JNC DKH/EU

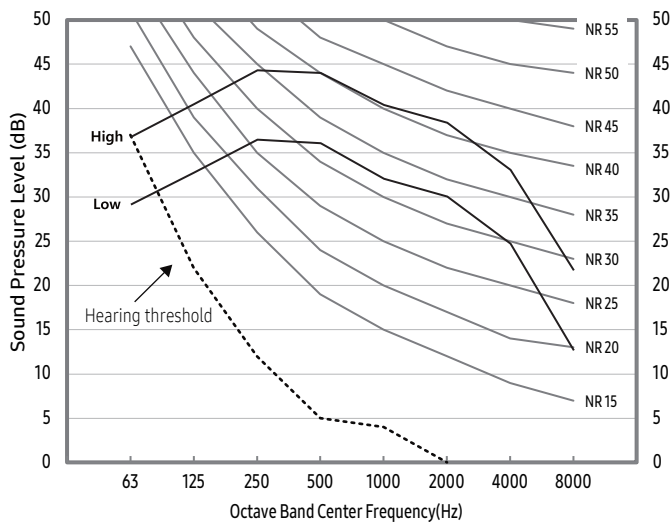

6 Sound power level

Big Ceiling

Note

- . Specifications may be subject to change without prior notice.
- . Sound power level is an absolute value that a sound source generates.
- . dBA = A-weighted sound power level.
- . Reference power : 1pW.
- . Measured according to ISO 3741

Unit: dB(A)

Model	Power
AM112JNCDKH/EU	61
AM140JNCDKH/EU	63

1)AM112JNCDKH/EU

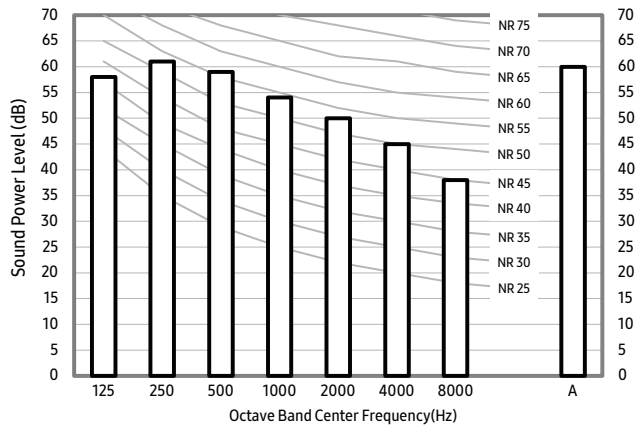

2)AM140JNCDKH/EU

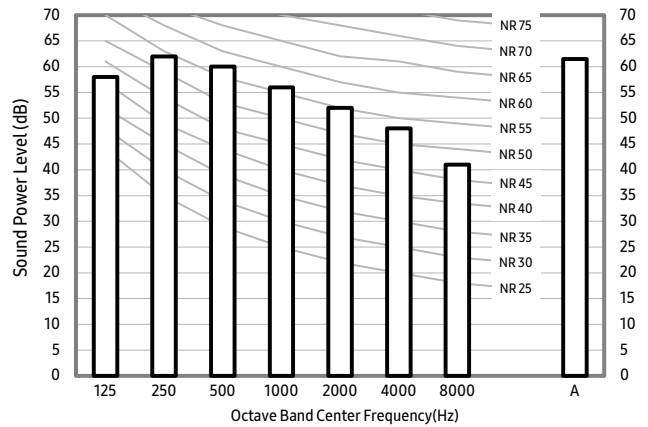

7 Temperature and air flow distribution

Big Ceiling

AM112JNCDKH/EU

(1) Cooling air velocity distribution

Discharge angle : 32°

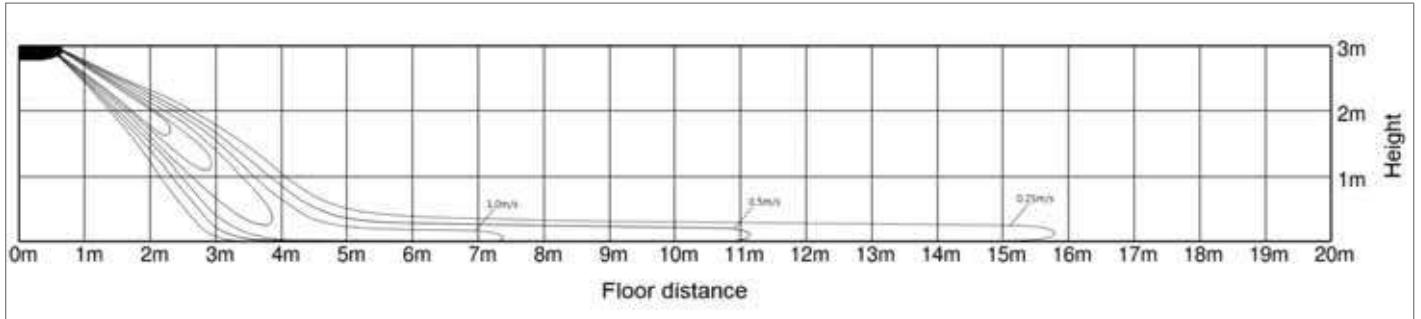

(2) Cooling temperature distribution

Discharge angle : 32°

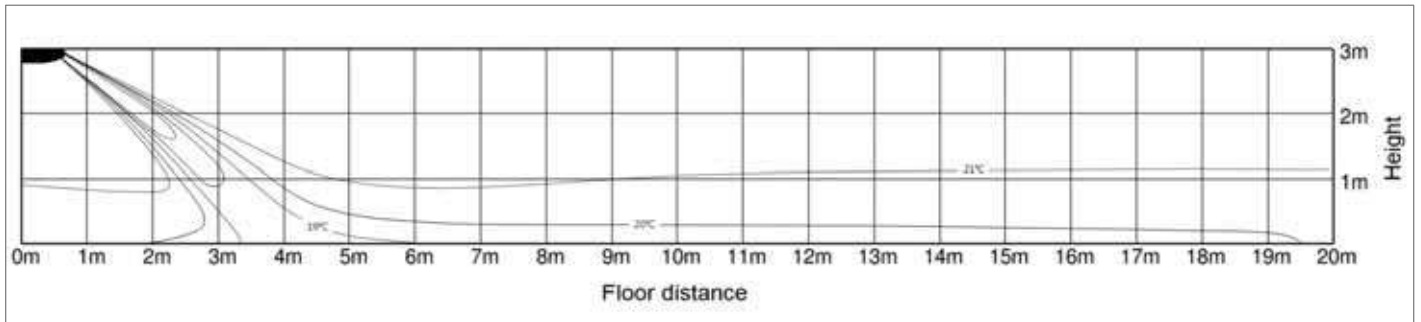

(3) Heating air velocity distribution

Discharge angle : 43°

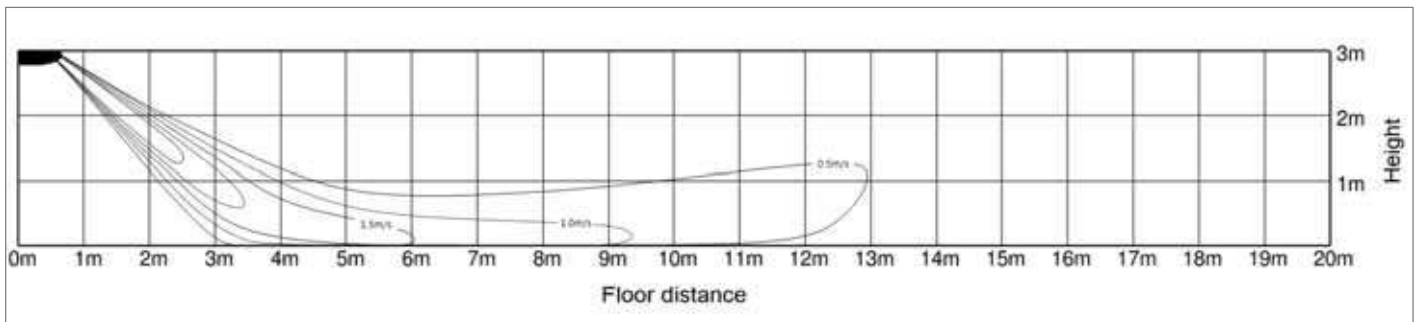

(4) Heating temperature distribution

Discharge angle : 43°

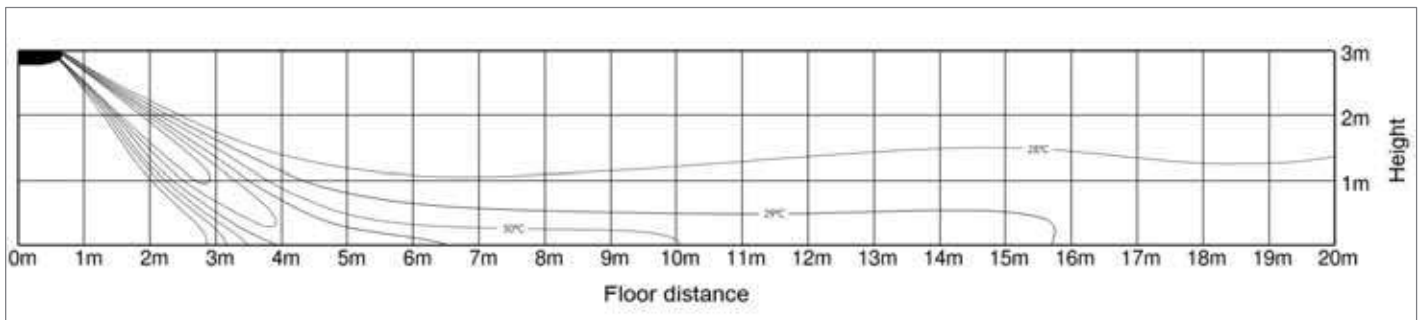

7 Temperature and air flow distribution

Big Ceiling

AM140JNC DKH/EU

(1) Cooling air velocity distribution

Discharge angle : 32°

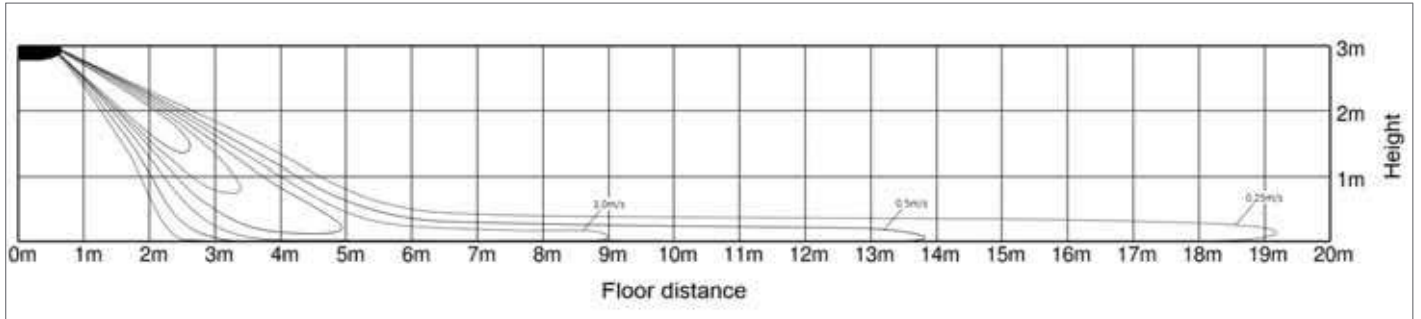

(2) Cooling temperature distribution

Discharge angle : 32°

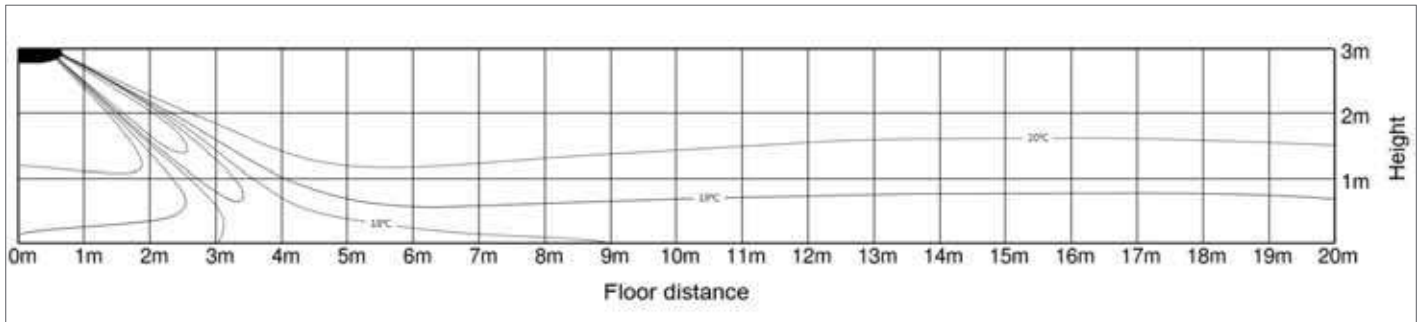

(3) Heating air velocity distribution

Discharge angle : 43°

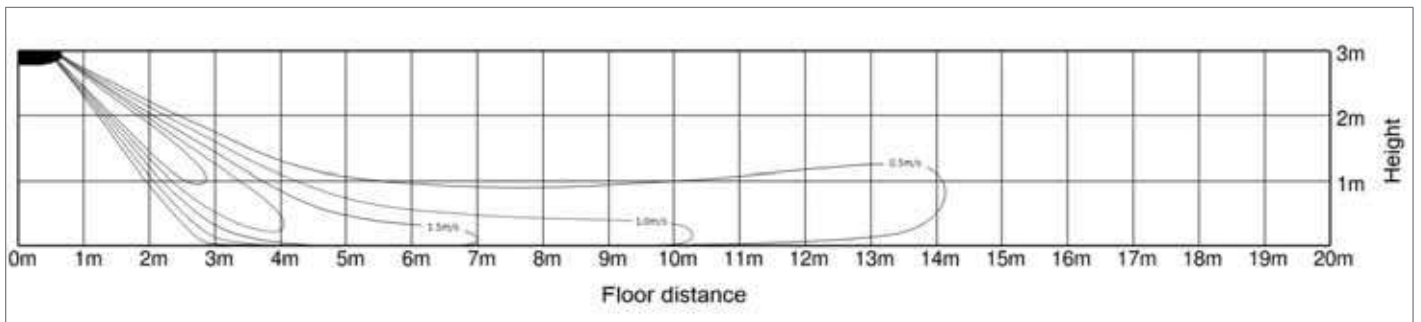

(4) Heating temperature distribution

Discharge angle : 43°

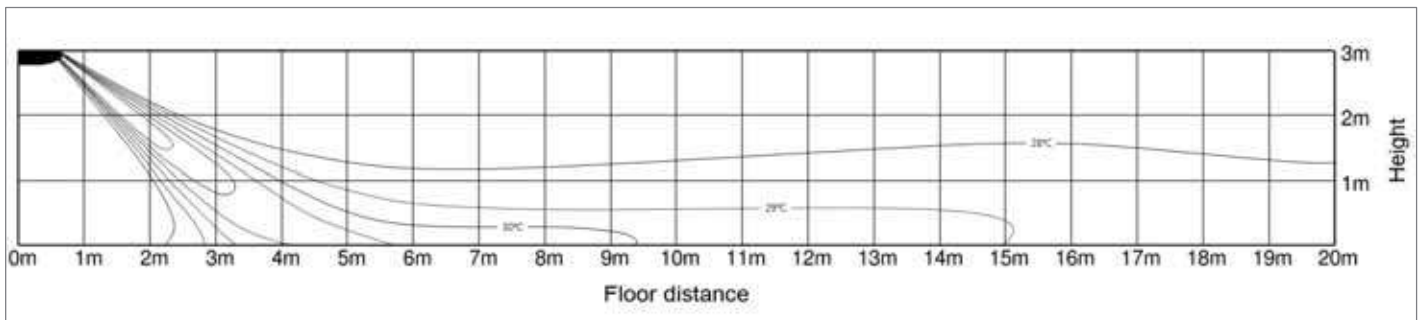

Console

- 1 *Specifications*
- 2 *Capacity Table*
- 3 *Dimensional Drawing*
- 4 *Electrical Wiring Diagram*
- 5 *Sound Pressure Level*
- 6 *Sound Power Level*
- 7 *Temperature and air flow distribution*

1 Specifications

Console

Type			Console		Console	
Model			AM022KNJDEH/EU		AM045KNJDEH/EU	
Power Supply			Ø, #, V, Hz	1,2,220-240,50	1,2,220-240,50	
Mode			-	HP/HR	HP/HR	
Performance	Capacity (Nominal)	Cooling	kW	2.20	4.50	
			Btu/h	7,500	15,400	
		Heating	kW	2.50	5.00	
			Btu/h	8,500	17,100	
Power	Power Input (Nominal)	Cooling	W	16.00	36.00	
		Heating	W	16.00	36.00	
	Current Input (Nominal)	Cooling	A	0.13	0.30	
		Heating	A	0.13	0.30	
Fan	Motor	Type	-	Turbo Fan	Turbo Fan	
		Output x n	w	37 x 1	37 x 1	
	Air Flow Rate	H/M/L (UL)	CMM	6.30 / 5.40 / 4.90	11.30 / 9.80 / 8.20	
			l/s	105.00 / 90.00 / 81.67	188.33 / 163.33 / 136.67	
	External Pressure	Min/Std/Max	mmAq	-	-	
Pa			-	-		
Piping Connections	Liquid Pipe	Ø, mm	6.35	6.35		
		Ø, inch	1/4"	1/4"		
	Gas Pipe	Ø, mm	12.70	12.70		
		Ø, inch	1/2"	1/2"		
Drain Pipe	Ø, mm	ID18 HOSE	ID18 HOSE			
Field Wiring	Power Source Wire	mm ²	1.5 - 2.5	1.5 - 2.5		
	Transmission Cable	mm ²	0.75 - 1.50	0.75 - 1.50		
Refrigerant	Type	-	R410A	R410A		
	Control Method	-	EEV INCLUDED	EEV INCLUDED		
Sound	Pressure	High / Mid / Low	dB(A)	34 / 32 / 30	42 / 39 / 36	
	Power	Cooling		52	63	
Dimension	Net Weight		kg	15.50	16.00	
	Shipping Weight		kg	20.50	21.00	
	Net Dimensions (WxHxD)		mm	720 x 620 x 199	720 x 620 x 199	
	Shipping Dimensions (WxHxD)		mm	810 x 710 x 295	810 x 710 x 295	
Panel Size	Panel model		-	-	-	
	Panel Net Weight		kg	-	-	
	Shipping Weight		kg	-	-	
	Net Dimensions (WxHxD)		mm	-	-	
	Shipping Dimensions (WxHxD)		mm	-	-	
Additional Accessories	Drain Pump	Drain Pump	- / Model	-	-	
		Max. lifting Height / Displacement	mm/liter/h	-	-	
	Air Filter		-	-	-	

NOTE

- 1) Mode : HP(Heat Pump), HR(Heat Recovery)
 - 2) Nominal Cooling : Indoor temperature 27°CDB / 19°CWB, Outdoor temperature 35°CDB/24°CWB, Refrigerant pipe length 7.5m, Level difference 0m.
 - 3) Nominal Heating : Indoor temperature 20°CDB / 15°CWB, Outdoor temperature 7°CDB / 6°CWB, Refrigerant pipe length 7.5m, Level difference 0m.
 - 4) Sound level was acquired in an anechoic room. Thus actual noise level may be different depending on the installation conditions.
 - 5) These products contain R410A which is fluorinated greenhouse gas.
 - 6) Specifications may be subject to change without prior notice.
- * Heat Exchanger type : Fin & Tube (Fin : Al, Tube : Cu)

1 Specifications

Console

Model				AM028FNJDEH/EU	AM036FNJDEH/EU	AM056FNJDEH/EU	
Power Supply		Ø, #, V, Hz		1, 2, 220~240, 50	1, 2, 220~240, 50	1, 2, 220~240, 50	
Mode				HP/HR	HP/HR	HP/HR	
Performance	Capacity (Nominal)	Cooling	kW	2.8	3.6	5.6	
			Btu/h	9,600	12,300	19,100	
		Heating	kW	3.2	4.0	6.3	
			Btu/h	10,900	13,600	21,500	
Power	Power Input (Nominal)	Cooling	W	30	35	62	
		Heating	W	30	35	62	
	Current Input (Nominal)	Cooling	A	0.25	0.29	0.49	
		Heating	A	0.25	0.29	0.49	
Fan	Motor	Type	-	Turbo Fan	Turbo Fan	Turbo Fan	
		Output	W	37	37	37	
		Number of unit	EA	1	1	1	
	Air Flow Rate	H/M/L (UL)	CMM	7.00/6.00/5.00	8.50/7.50/6.50	13.00/11.50/10.00	
			l/s	116.67/100.00/83.33	141.67/125.00/108.33	216.67/191.67/166.67	
	External Pressure	Min / Std / Max	mmAq	-	-	-	
			Pa	-	-	-	
WG			-	-	-		
Option Code				-	019044-1950B7-201C1C-330010	019044-1950D7-202424-330010	019044-19541B-203838-330010
Piping Connections	Liquid Pipe	Ø, mm	6.35	6.35	6.35		
		Ø, inch	1/4	1/4	1/4		
	Gas Pipe	Ø, mm	12.70	12.70	12.70		
		Ø, inch	1/2	1/2	1/2		
	Drain Pipe	Ø, mm	ID 18 HOSE	ID 18 HOSE	ID 18 HOSE		
Field Wiring	Power Source Wire	Below 20m / over 20m	mm ²	1.5 / 2.5	1.5 / 2.5	1.5 / 2.5	
	Transmission Cable		mm ²	0.75~1.5	0.75~1.5	0.75~1.5	
Refrigerant	Type		-	R410A	R410A	R410A	
	Control Method		-	EEV INCLUDED	EEV INCLUDED	EEV INCLUDED	
Sound	Sound Pressure	High / Mid / Low	dBA	38 / 36 / 34	39 / 37 / 34	43 / 40 / 37	
	Sound Power		dBA	58	59	64	
Dimensions	Net Weight		kg	16.00	16.00	16.00	
	Shipping Weight		kg	21.00	21.00	21.00	
	Net Dimensions (WxHxD)		mm	720 x 620 x 199	720 x 620 x 199	720 x 620 x 199	
	Shipping Dimensions (WxHxD)		mm	810 x 710 x 295	810 x 710 x 295	810 x 710 x 295	
Panel Size	Panel model		-	-	-	-	
	Panel Net Weight		kg	-	-	-	
	Shipping Weight		kg	-	-	-	
	Net Dimensions (WxHxD)		mm	-	-	-	
	Shipping Dimensions (WxHxD)		mm	-	-	-	
Additional Accessories	Drain pump	Drain pump	- / Model	-	-	-	
		Max. lifting Height / Displacement	mm/liter/h	-	-	-	
	Air Filter		-	Long life filter	Long life filter	Long life filter	

NOTE

- 1) Mode : HP(Heat Pump), HR(Heat Recovery)
 - 2) Nominal Cooling : Indoor temperature 27°CDB / 19°CWB, Outdoor temperature 35°CDB/24°CWB, Refrigerant pipe length 7.5m, Level difference 0m.
 - 3) Nominal Heating : Indoor temperature 20°CDB / 15°CWB, Outdoor temperature 7°CDB / 6°CWB, Refrigerant pipe length 7.5m, Level difference 0m.
 - 4) Sound level was acquired in an anechoic room. Thus actual noise level may be different depending on the installation conditions.
 - 5) These products contain R410A which is fluorinated greenhouse gas.
 - 6) Specifications may be subject to change without prior notice.
- * Heat Exchanger type : Fin & Tube (Fin : Al, Tube : Cu)

2 Capacity Table

Console

Cooling

TC : Total Capacity(kW), SHC : Sensible Heat Capacity(kW)

Capacity Index	Outdoor Air Temp. (°C,DB)	Indoor temperature													
		20(°C,DB)		23(°C,DB)		26(°C,DB)		27(°C,DB)		28(°C,DB)		30(°C,DB)		32(°C,DB)	
		14(°C,WB)		16(°C,WB)		18(°C,WB)		19(°C,WB)		20(°C,WB)		22(°C,WB)		24(°C,WB)	
		TC	SHC	TC	SHC	TC	SHC	TC	SHC	TC	SHC	TC	SHC	TC	SHC
022	10	1.5	1.3	1.8	1.5	2.1	1.5	2.2	1.5	2.3	1.5	2.5	1.6	2.6	1.4
	12	1.5	1.3	1.8	1.5	2.1	1.5	2.2	1.5	2.3	1.5	2.5	1.6	2.6	1.4
	14	1.5	1.3	1.8	1.5	2.1	1.5	2.2	1.5	2.3	1.5	2.5	1.6	2.6	1.4
	16	1.5	1.3	1.8	1.5	2.1	1.5	2.2	1.5	2.3	1.5	2.4	1.5	2.6	1.4
	18	1.5	1.3	1.8	1.5	2.1	1.5	2.2	1.5	2.3	1.5	2.4	1.5	2.6	1.4
	20	1.5	1.3	1.8	1.5	2.1	1.5	2.2	1.5	2.3	1.5	2.4	1.5	2.6	1.4
	21	1.5	1.3	1.8	1.5	2.1	1.5	2.2	1.5	2.3	1.5	2.4	1.5	2.6	1.4
	23	1.5	1.3	1.8	1.5	2.1	1.5	2.2	1.5	2.3	1.5	2.4	1.5	2.6	1.4
	25	1.5	1.3	1.8	1.5	2.1	1.5	2.2	1.5	2.3	1.5	2.4	1.5	2.6	1.4
	27	1.5	1.3	1.8	1.5	2.1	1.5	2.2	1.5	2.3	1.5	2.4	1.5	2.6	1.4
	29	1.5	1.3	1.8	1.5	2.1	1.5	2.2	1.5	2.3	1.5	2.4	1.5	2.6	1.4
	31	1.5	1.3	1.8	1.5	2.1	1.5	2.2	1.5	2.3	1.5	2.4	1.5	2.6	1.4
	33	1.5	1.3	1.8	1.5	2.1	1.5	2.2	1.5	2.3	1.5	2.4	1.5	2.6	1.4
	35	1.5	1.3	1.8	1.5	2.1	1.5	2.2	1.5	2.3	1.5	2.4	1.5	2.6	1.4
	37	1.5	1.3	1.8	1.5	2.1	1.5	2.2	1.5	2.3	1.5	2.4	1.5	2.6	1.4
	39	1.5	1.3	1.8	1.5	2.1	1.5	2.2	1.5	2.3	1.5	2.4	1.5	2.5	1.3
42	1.5	1.3	1.8	1.5	2.1	1.5	2.2	1.5	2.3	1.5	2.4	1.5	2.4	1.3	
44	1.5	1.3	1.8	1.5	2.0	1.4	2.1	1.4	2.2	1.4	2.3	1.4	2.4	1.2	
46	1.5	1.3	1.8	1.5	2.0	1.4	2.0	1.4	2.1	1.4	2.2	1.4	2.3	1.2	
48	1.5	1.3	1.8	1.5	2.0	1.4	2.0	1.3	2.1	1.4	2.1	1.3	2.2	1.1	
028	10	1.9	1.6	2.3	1.8	2.6	2.0	2.8	1.9	2.9	1.9	3.1	1.9	3.4	1.9
	12	1.9	1.6	2.3	1.8	2.6	2.0	2.8	1.9	2.9	1.9	3.1	1.9	3.3	1.8
	14	1.9	1.6	2.3	1.8	2.6	2.0	2.8	1.9	2.9	1.9	3.1	1.9	3.3	1.8
	16	1.9	1.6	2.3	1.8	2.6	2.0	2.8	1.9	2.9	1.9	3.1	1.9	3.3	1.8
	18	1.9	1.6	2.3	1.8	2.6	2.0	2.8	1.9	2.9	1.9	3.1	1.9	3.3	1.8
	20	1.9	1.6	2.3	1.8	2.6	2.0	2.8	1.9	2.9	1.9	3.1	1.9	3.3	1.8
	21	1.9	1.6	2.3	1.8	2.6	2.0	2.8	1.9	2.9	1.9	3.1	1.9	3.3	1.8
	23	1.9	1.6	2.3	1.8	2.6	2.0	2.8	1.9	2.9	1.9	3.1	1.9	3.3	1.8
	25	1.9	1.6	2.3	1.8	2.6	2.0	2.8	1.9	2.9	1.9	3.1	1.9	3.3	1.8
	27	1.9	1.6	2.3	1.8	2.6	2.0	2.8	1.9	2.9	1.9	3.1	1.9	3.3	1.8
	29	1.9	1.6	2.3	1.8	2.6	2.0	2.8	1.9	2.9	1.9	3.1	1.9	3.3	1.8
	31	1.9	1.6	2.3	1.8	2.6	2.0	2.8	1.9	2.9	1.9	3.1	1.9	3.3	1.8
	33	1.9	1.6	2.3	1.8	2.6	2.0	2.8	1.9	2.9	1.9	3.1	1.9	3.3	1.8
	35	1.9	1.6	2.3	1.8	2.6	2.0	2.8	1.9	2.9	1.9	3.1	1.9	3.3	1.8
	37	1.9	1.6	2.3	1.8	2.6	2.0	2.8	1.9	2.9	1.9	3.1	1.9	3.3	1.8
	39	1.9	1.6	2.3	1.8	2.6	2.0	2.8	1.9	2.9	1.9	3.0	1.8	3.2	1.7
42	1.9	1.6	2.3	1.8	2.6	2.0	2.8	1.9	2.9	1.9	2.9	1.8	3.1	1.7	
44	1.9	1.6	2.3	1.8	2.5	1.9	2.7	1.8	2.8	1.8	2.8	1.7	3.0	1.6	
46	1.9	1.6	2.3	1.8	2.5	1.9	2.6	1.8	2.7	1.8	2.7	1.6	2.9	1.6	
48	1.9	1.6	2.2	1.8	2.4	1.9	2.5	1.7	2.6	1.7	2.7	1.6	2.8	1.5	
036	10	2.5	2.1	2.9	2.2	3.4	2.3	3.6	2.4	3.7	2.4	4.0	2.4	4.3	2.3
	12	2.5	2.1	2.9	2.2	3.4	2.3	3.6	2.4	3.7	2.4	4.0	2.4	4.3	2.3
	14	2.5	2.1	2.9	2.2	3.4	2.3	3.6	2.4	3.7	2.4	4.0	2.4	4.3	2.3
	16	2.5	2.1	2.9	2.2	3.4	2.3	3.6	2.4	3.7	2.4	4.0	2.4	4.3	2.3
	18	2.5	2.1	2.9	2.2	3.4	2.3	3.6	2.4	3.7	2.4	4.0	2.4	4.3	2.3
	20	2.5	2.1	2.9	2.2	3.4	2.3	3.6	2.4	3.7	2.4	4.0	2.4	4.2	2.3
	21	2.5	2.1	2.9	2.2	3.4	2.3	3.6	2.4	3.7	2.4	4.0	2.4	4.2	2.3
	23	2.5	2.1	2.9	2.2	3.4	2.3	3.6	2.4	3.7	2.4	4.0	2.4	4.2	2.3
	25	2.5	2.1	2.9	2.2	3.4	2.3	3.6	2.4	3.7	2.4	4.0	2.4	4.2	2.3
	27	2.5	2.1	2.9	2.2	3.4	2.3	3.6	2.4	3.7	2.4	4.0	2.4	4.2	2.3
	29	2.5	2.1	2.9	2.2	3.4	2.3	3.6	2.4	3.7	2.4	4.0	2.4	4.2	2.3
	31	2.5	2.1	2.9	2.2	3.4	2.3	3.6	2.4	3.7	2.4	4.0	2.4	4.2	2.3
	33	2.5	2.1	2.9	2.2	3.4	2.3	3.6	2.4	3.7	2.4	4.0	2.4	4.2	2.3
	35	2.5	2.1	2.9	2.2	3.4	2.3	3.6	2.4	3.7	2.4	4.0	2.4	4.2	2.3
	37	2.5	2.1	2.9	2.2	3.4	2.3	3.6	2.4	3.7	2.4	3.9	2.3	4.2	2.3
	39	2.5	2.1	2.9	2.2	3.4	2.3	3.6	2.4	3.7	2.4	3.9	2.3	4.1	2.2
42	2.5	2.1	2.9	2.2	3.4	2.3	3.6	2.4	3.7	2.4	3.8	2.3	4.0	2.1	
44	2.5	2.1	2.9	2.2	3.3	2.2	3.4	2.3	3.6	2.3	3.7	2.2	3.9	2.1	
46	2.5	2.1	2.9	2.2	3.2	2.2	3.3	2.2	3.4	2.2	3.6	2.1	3.8	2.0	
48	2.5	2.1	2.8	2.2	3.2	2.1	3.2	2.2	3.4	2.2	3.5	2.0	3.6	1.9	

2 Capacity Table

Console

Cooling

TC : Total Capacity(kW), SHC : Sensible Heat Capacity(kW)

Capacity Index	Outdoor Air Temp. (°C,DB)	Indoor temperature													
		20(°C,DB)		23(°C,DB)		26(°C,DB)		27(°C,DB)		28(°C,DB)		30(°C,DB)		32(°C,DB)	
		14(°C,WB)		16(°C,WB)		18(°C,WB)		19(°C,WB)		20(°C,WB)		22(°C,WB)		24(°C,WB)	
		TC	SHC	TC	SHC	TC	SHC	TC	SHC	TC	SHC	TC	SHC	TC	SHC
045	10	3.1	2.4	3.7	2.7	4.3	2.9	4.5	3.0	4.7	3.0	5.1	3.1	5.4	2.8
	12	3.1	2.4	3.7	2.7	4.3	2.9	4.5	3.0	4.7	3.0	5.1	3.1	5.4	2.8
	14	3.1	2.4	3.7	2.7	4.3	2.9	4.5	3.0	4.7	3.0	5.0	3.0	5.4	2.8
	16	3.1	2.4	3.7	2.7	4.3	2.9	4.5	3.0	4.7	3.0	5.0	3.0	5.3	2.8
	18	3.1	2.4	3.7	2.7	4.3	2.9	4.5	3.0	4.7	3.0	5.0	3.0	5.3	2.8
	20	3.1	2.4	3.7	2.7	4.3	2.9	4.5	3.0	4.7	3.0	5.0	3.0	5.3	2.8
	21	3.1	2.4	3.7	2.7	4.3	2.9	4.5	3.0	4.7	3.0	5.0	3.0	5.3	2.8
	23	3.1	2.4	3.7	2.7	4.3	2.9	4.5	3.0	4.7	3.0	5.0	3.0	5.3	2.8
	25	3.1	2.4	3.7	2.7	4.3	2.9	4.5	3.0	4.7	3.0	5.0	3.0	5.3	2.8
	27	3.1	2.4	3.7	2.7	4.3	2.9	4.5	3.0	4.7	3.0	5.0	3.0	5.3	2.8
	29	3.1	2.4	3.7	2.7	4.3	2.9	4.5	3.0	4.7	3.0	5.0	3.0	5.3	2.8
	31	3.1	2.4	3.7	2.7	4.3	2.9	4.5	3.0	4.7	3.0	5.0	3.0	5.3	2.8
	33	3.1	2.4	3.7	2.7	4.3	2.9	4.5	3.0	4.7	3.0	5.0	3.0	5.3	2.8
	35	3.1	2.4	3.7	2.7	4.3	2.9	4.5	3.0	4.7	3.0	5.0	3.0	5.3	2.8
	37	3.1	2.4	3.7	2.7	4.3	2.9	4.5	3.0	4.7	3.0	4.9	2.9	5.2	2.7
	39	3.1	2.4	3.7	2.7	4.3	2.9	4.5	3.0	4.7	3.0	4.9	2.9	5.1	2.6
42	3.1	2.4	3.7	2.7	4.2	2.9	4.4	3.0	4.6	3.0	4.8	2.9	5.0	2.5	
44	3.1	2.4	3.7	2.7	4.1	2.8	4.3	2.9	4.5	2.9	4.6	2.8	4.8	2.5	
46	3.1	2.4	3.7	2.7	4.0	2.8	4.2	2.8	4.3	2.8	4.5	2.7	4.7	2.4	
48	3.1	2.3	3.6	2.6	4.0	2.7	4.0	2.7	4.3	2.7	4.3	2.6	4.5	2.3	
056	10	3.9	3.0	4.6	3.4	5.3	3.7	5.6	3.8	5.8	3.8	6.3	3.9	6.7	3.6
	12	3.9	3.0	4.6	3.4	5.3	3.7	5.6	3.8	5.8	3.8	6.3	3.9	6.7	3.6
	14	3.9	3.0	4.6	3.4	5.3	3.7	5.6	3.8	5.8	3.8	6.2	3.8	6.7	3.6
	16	3.9	3.0	4.6	3.4	5.3	3.7	5.6	3.8	5.8	3.8	6.2	3.8	6.6	3.5
	18	3.9	3.0	4.6	3.4	5.3	3.7	5.6	3.8	5.8	3.8	6.2	3.8	6.6	3.5
	20	3.9	3.0	4.6	3.4	5.3	3.7	5.6	3.8	5.8	3.8	6.2	3.8	6.6	3.5
	21	3.9	3.0	4.6	3.4	5.3	3.7	5.6	3.8	5.8	3.8	6.2	3.8	6.6	3.5
	23	3.9	3.0	4.6	3.4	5.3	3.7	5.6	3.8	5.8	3.8	6.2	3.8	6.6	3.5
	25	3.9	3.0	4.6	3.4	5.3	3.7	5.6	3.8	5.8	3.8	6.2	3.8	6.6	3.5
	27	3.9	3.0	4.6	3.4	5.3	3.7	5.6	3.8	5.8	3.8	6.2	3.8	6.6	3.5
	29	3.9	3.0	4.6	3.4	5.3	3.7	5.6	3.8	5.8	3.8	6.2	3.8	6.6	3.5
	31	3.9	3.0	4.6	3.4	5.3	3.7	5.6	3.8	5.8	3.8	6.2	3.8	6.6	3.5
	33	3.9	3.0	4.6	3.4	5.3	3.7	5.6	3.8	5.8	3.8	6.2	3.8	6.6	3.5
	35	3.9	3.0	4.6	3.4	5.3	3.7	5.6	3.8	5.8	3.8	6.2	3.8	6.6	3.5
	37	3.9	3.0	4.6	3.4	5.3	3.7	5.6	3.8	5.8	3.8	6.1	3.7	6.5	3.4
	39	3.9	3.0	4.6	3.4	5.3	3.7	5.6	3.8	5.8	3.8	6.1	3.7	6.4	3.3
42	3.9	3.0	4.6	3.4	5.3	3.7	5.5	3.7	5.7	3.8	6.0	3.6	6.2	3.2	
44	3.9	3.0	4.6	3.4	5.1	3.6	5.3	3.6	5.6	3.6	5.8	3.5	6.0	3.1	
46	3.9	3.0	4.6	3.4	5.0	3.5	5.2	3.5	5.4	3.5	5.6	3.4	5.9	3.0	
48	3.9	3.0	4.5	3.3	5.0	3.5	5.0	3.4	5.3	3.5	5.4	3.3	5.7	2.9	

2 Capacity Table

Console

Heating

TC : Total Capacity(kW)

Capacity Index	Outdoor Air Temp. (°C)		Indoor temperature (°C,DB)				
			16(°C,DB)	18(°C,DB)	20(°C,DB)	22(°C,DB)	24(°C,DB)
	DB	WB	TC kW	TC kW	TC kW	TC kW	TC kW
022	-19.8	-20.0	1.5	1.5	1.5	1.5	1.5
	-18.8	-19.0	1.5	1.5	1.5	1.5	1.5
	-16.7	-17.0	1.6	1.6	1.6	1.6	1.6
	-14.7	-15.0	1.7	1.6	1.6	1.6	1.6
	-12.6	-13.0	1.8	1.8	1.8	1.8	1.7
	-10.5	-11.0	2.0	2.0	1.9	1.9	1.9
	-9.5	-10.0	2.1	2.0	2.0	1.9	1.9
	-8.5	-9.1	2.2	2.1	2.1	2.0	2.0
	-7.0	-7.6	2.3	2.2	2.2	2.0	2.0
	-5.0	-5.6	2.4	2.3	2.3	2.2	2.2
	-3.0	-3.7	2.5	2.5	2.4	2.3	2.2
	0.0	-0.7	2.6	2.5	2.5	2.3	2.2
	3.0	2.2	2.7	2.6	2.5	2.3	2.2
	5.0	4.1	2.8	2.7	2.5	2.3	2.2
	7.0	6.0	2.8	2.7	2.5	2.3	2.2
9.0	7.9	3.0	2.7	2.5	2.3	2.2	
11.0	9.8	3.0	2.7	2.5	2.3	2.2	
13.0	11.8	3.0	2.7	2.5	2.3	2.2	
15.0	13.7	3.0	2.7	2.5	2.3	2.2	
028	-19.8	-20.0	1.9	1.9	1.9	1.9	1.9
	-18.8	-19.0	1.9	1.9	1.9	1.9	1.9
	-16.7	-17.0	2.0	2.0	2.0	2.0	1.9
	-14.7	-15.0	2.1	2.1	2.0	2.0	1.9
	-12.6	-13.0	2.2	2.2	2.2	2.1	2.1
	-10.5	-11.0	2.3	2.3	2.3	2.3	2.2
	-9.5	-10.0	2.3	2.3	2.3	2.3	2.2
	-8.5	-9.1	2.4	2.4	2.4	2.4	2.3
	-7.0	-7.6	2.5	2.4	2.4	2.4	2.3
	-5.0	-5.6	2.6	2.6	2.5	2.5	2.4
	-3.0	-3.7	2.8	2.7	2.7	2.6	2.5
	0.0	-0.7	2.9	2.8	2.8	2.7	2.6
	3.0	2.2	3.0	3.0	2.9	2.8	2.7
	5.0	4.1	3.2	3.1	3.1	2.9	2.7
	7.0	6.0	3.3	3.2	3.2	3.0	2.7
9.0	7.9	3.4	3.3	3.2	3.0	2.7	
11.0	9.8	3.5	3.3	3.2	3.0	2.7	
13.0	11.8	3.6	3.4	3.2	3.0	2.7	
15.0	13.7	3.7	3.4	3.2	3.0	2.7	
036	-19.8	-20.0	2.4	2.4	2.3	2.3	2.3
	-18.8	-19.0	2.5	2.4	2.3	2.3	2.3
	-16.7	-17.0	2.6	2.5	2.4	2.4	2.3
	-14.7	-15.0	2.7	2.6	2.5	2.5	2.4
	-12.6	-13.0	2.8	2.7	2.7	2.6	2.6
	-10.5	-11.0	2.9	2.9	2.9	2.8	2.8
	-9.5	-10.0	2.9	2.9	2.9	2.8	2.8
	-8.5	-9.1	3.0	3.0	3.0	2.9	2.9
	-7.0	-7.6	3.1	3.1	3.0	3.0	2.9
	-5.0	-5.6	3.3	3.2	3.2	3.1	3.0
	-3.0	-3.7	3.4	3.4	3.3	3.2	3.1
	0.0	-0.7	3.6	3.6	3.5	3.4	3.2
	3.0	2.2	3.8	3.7	3.7	3.5	3.4
	5.0	4.1	3.9	3.9	3.8	3.6	3.4
	7.0	6.0	4.1	4.1	4.0	3.7	3.4
9.0	7.9	4.2	4.1	4.0	3.7	3.4	
11.0	9.8	4.4	4.2	4.0	3.7	3.4	
13.0	11.8	4.5	4.2	4.0	3.7	3.4	
15.0	13.7	4.6	4.3	4.0	3.7	3.4	

2 Capacity Table

Console

Heating

TC : Total Capacity(kW)

Capacity Index	Outdoor Air Temp. (°C)		Indoor temperature (°C,DB)				
			16(°C,DB)	18(°C,DB)	20(°C,DB)	22(°C,DB)	24(°C,DB)
	DB	WB	TC kW	TC kW	TC kW	TC kW	TC kW
045	-19.8	-20.0	3.1	3.0	3.0	2.9	2.9
	-18.8	-19.0	3.1	3.1	3.1	3.0	3.0
	-16.7	-17.0	3.2	3.2	3.1	3.0	3.0
	-14.7	-15.0	3.3	3.3	3.2	3.1	3.0
	-12.6	-13.0	3.5	3.4	3.3	3.3	3.2
	-10.5	-11.0	3.6	3.6	3.5	3.5	3.4
	-9.5	-10.0	3.7	3.7	3.6	3.5	3.5
	-8.5	-9.1	3.8	3.7	3.7	3.6	3.5
	-7.0	-7.6	3.9	3.8	3.8	3.7	3.6
	-5.0	-5.6	4.1	4.1	4.0	3.9	3.7
	-3.0	-3.7	4.3	4.2	4.2	4.1	3.9
	0.0	-0.7	4.5	4.4	4.4	4.2	4.0
	3.0	2.2	4.7	4.7	4.6	4.4	4.2
	5.0	4.1	4.9	4.8	4.8	4.5	4.2
	7.0	6.0	5.2	5.1	5.0	4.6	4.2
9.0	7.9	5.3	5.2	5.0	4.6	4.2	
11.0	9.8	5.5	5.2	5.0	4.6	4.2	
13.0	11.8	5.6	5.3	5.0	4.6	4.2	
15.0	13.7	5.8	5.4	5.0	4.6	4.2	
056	-19.8	-20.0	3.9	3.8	3.8	3.7	3.7
	-18.8	-19.0	3.9	3.9	3.8	3.7	3.7
	-16.7	-17.0	4.0	4.0	3.9	3.8	3.8
	-14.7	-15.0	4.2	4.1	4.0	3.9	3.8
	-12.6	-13.0	4.4	4.3	4.2	4.1	4.0
	-10.5	-11.0	4.6	4.5	4.4	4.4	4.3
	-9.5	-10.0	4.7	4.6	4.6	4.5	4.4
	-8.5	-9.1	4.8	4.7	4.7	4.6	4.5
	-7.0	-7.6	4.9	4.8	4.8	4.7	4.5
	-5.0	-5.6	5.2	5.1	5.0	4.9	4.7
	-3.0	-3.7	5.4	5.3	5.3	5.1	4.9
	0.0	-0.7	5.7	5.6	5.5	5.3	5.0
	3.0	2.2	5.9	5.9	5.8	5.6	5.3
	5.0	4.1	6.2	6.1	6.0	5.7	5.3
	7.0	6.0	6.5	6.4	6.3	5.8	5.3
9.0	7.9	6.7	6.5	6.3	5.8	5.3	
11.0	9.8	6.9	6.6	6.3	5.8	5.3	
13.0	11.8	7.1	6.7	6.3	5.8	5.3	
15.0	13.7	7.3	6.8	6.3	5.8	5.3	

3 Dimensional Drawing

Console

AM022/045KNJDEH/EU, AM028/036FNJDEH/EU

[Unit : mm]

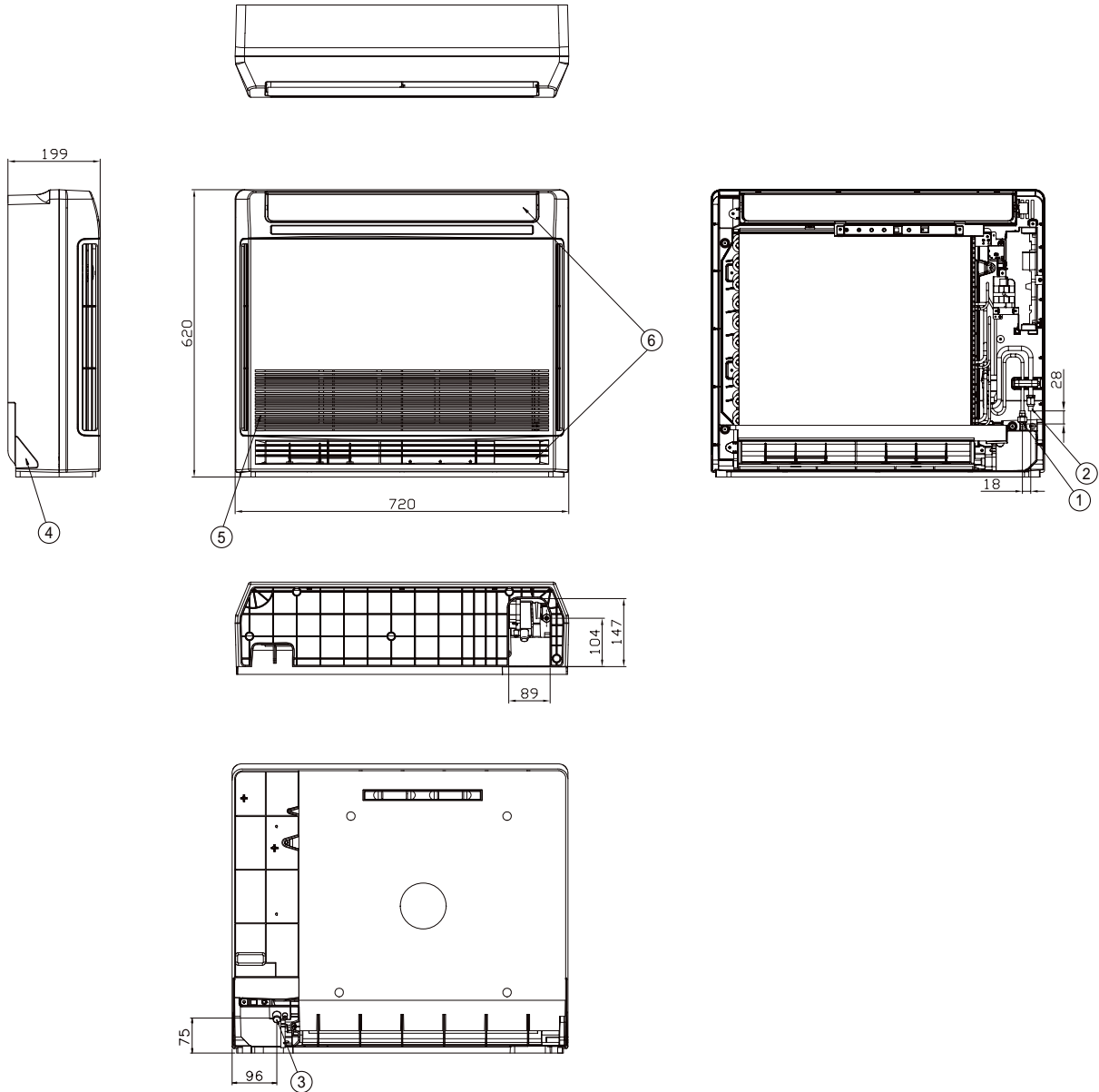

No.	Name	Description			
		2.2kW	2.8kW	3.6kW	4.5kW
①	Liquid pipe connection	Ø6.35 Flare			
②	Gas pipe connection	Ø12.70 Flare			
③	Drain pipe connection	ID18 Hose			
④	Conduit for power supply & communication wiring	-			
⑤	Air inlet grille	-			
⑥	Air outlet louver	-			

3 Dimensional Drawing

Console

AM056FNJDEH/EU

[Unit : mm]

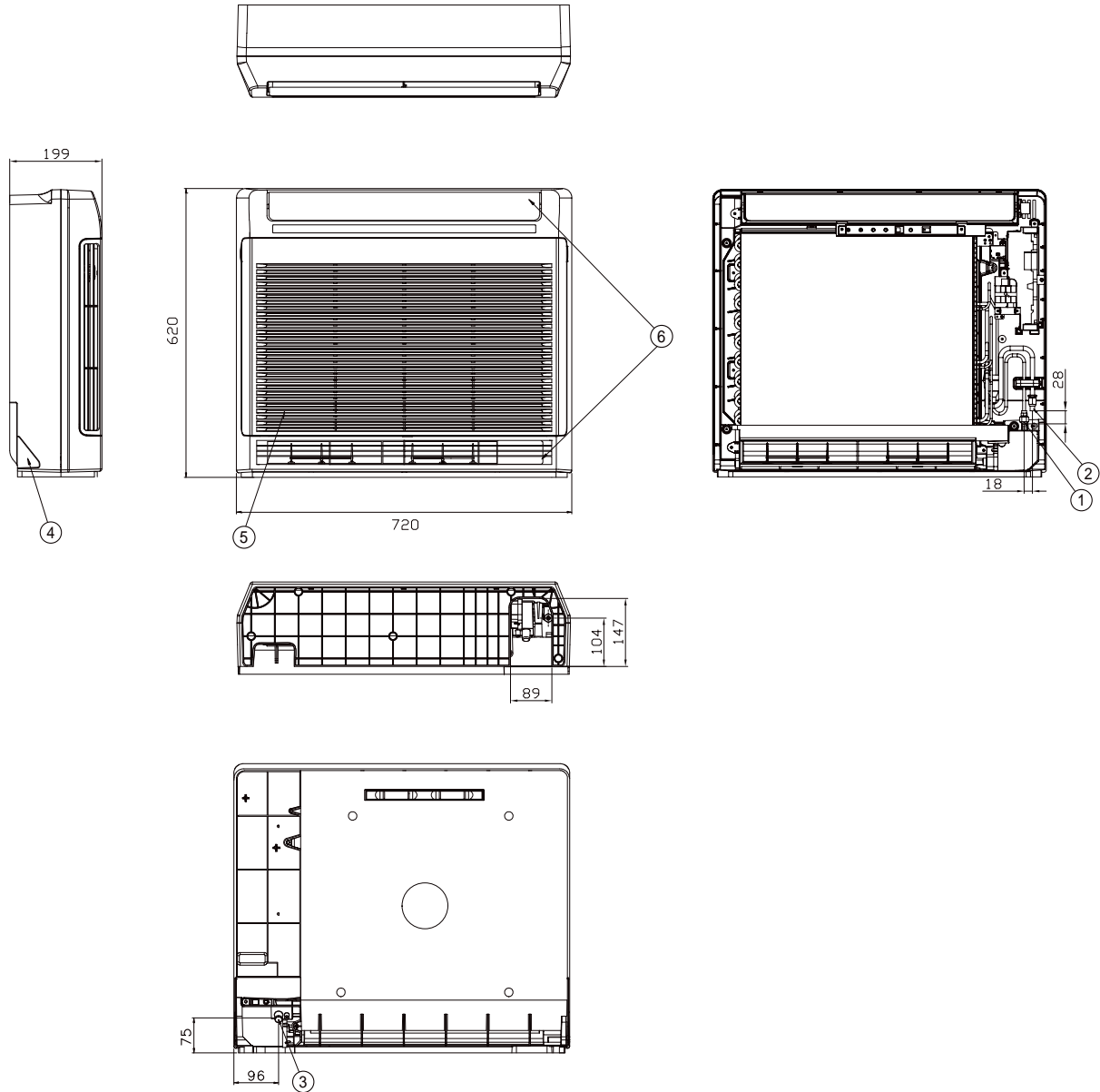

No.	Name	Description
		5.6kW
①	Liquid pipe connection	Ø6.35 Flare
②	Gas pipe connection	Ø12.70 Flare
③	Drain pipe connection	ID18 Hose
④	Conduit for power supply & communication wiring	-
⑤	Air inlet grille	-
⑥	Air outlet louver	-

4 Electrical Wiring Diagram

Console

AM022/045KNJDEH/EU, AM028/036/056FNJDEH/EU

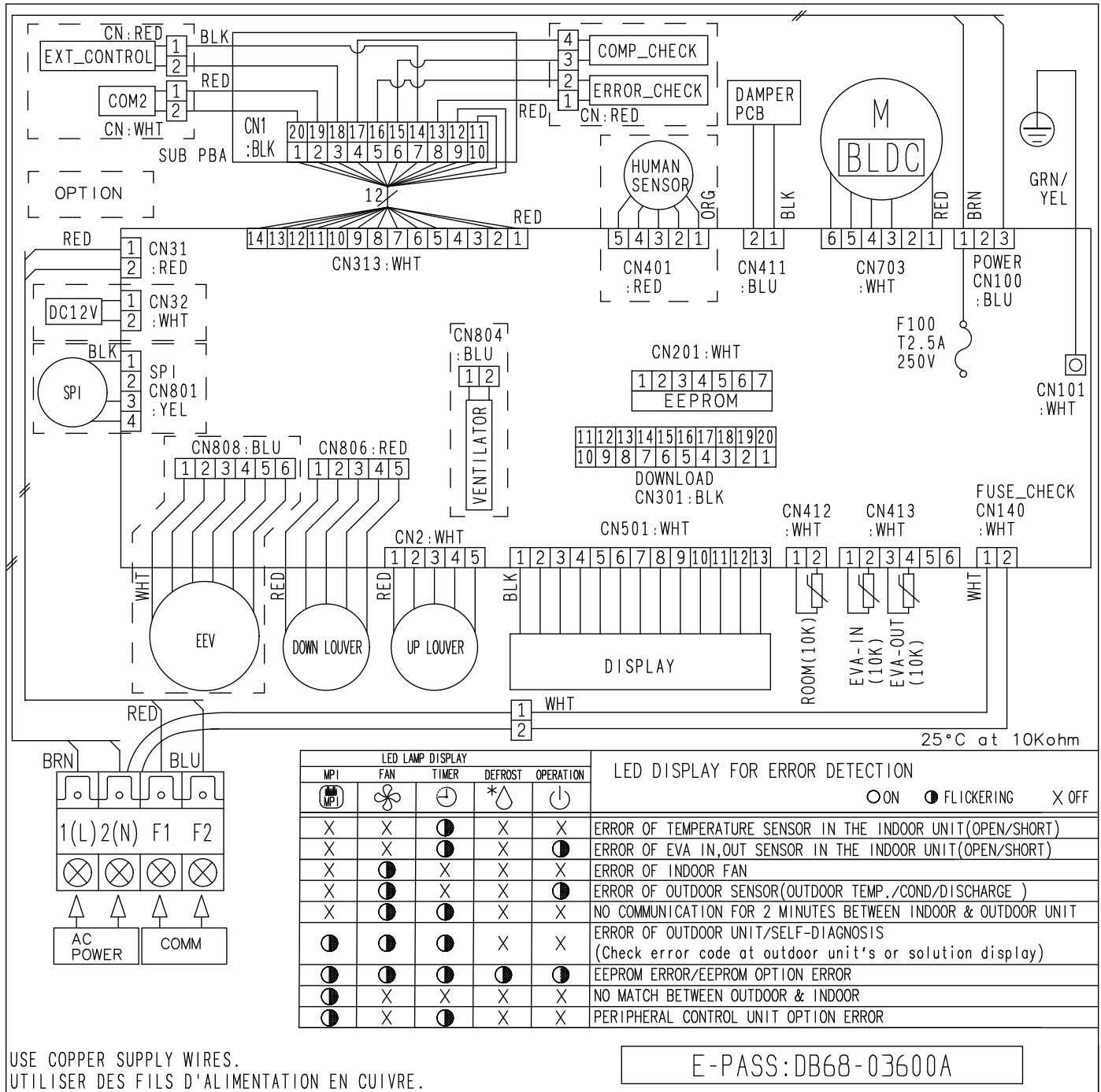

NOTE

- This wiring diagram applies only to the indoor unit.
- Symbols show as follow;
BLK : black, RED : red, BLU : blue, WHT:white, YEL : yellow, BRN : brown, SKY : sky-blue, GRN : green
- For connection wiring indoor-outdoor transmission F1-F2, indoor-wired remotecontroller transmission F3-F4.
- : Protective earth(screw), : Connector, n: The wire quantity

5 Sound Pressure Level

Console

Unit: dB(A)

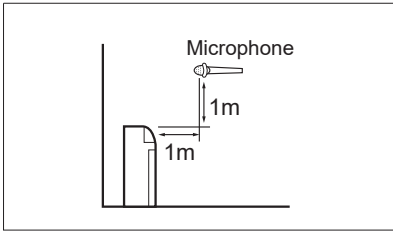

Model	High	Low
AM022KNJDEH/EU	34	30
AM045KNJDEH/EU	42	36

Note

Specifications may be subject to change without prior notice.
 Sound pressure level is obtained in an anechoic room.
 Sound pressure level is a relative value, depending on the distance and acoustic environment.
 Sound pressure level may differ depending on operation condition.
 dBA = A-weighted sound pressure level
 Reference acoustic pressure 0 dB= 20 uPa

NR curve

1) AM022KNJDEH/EU

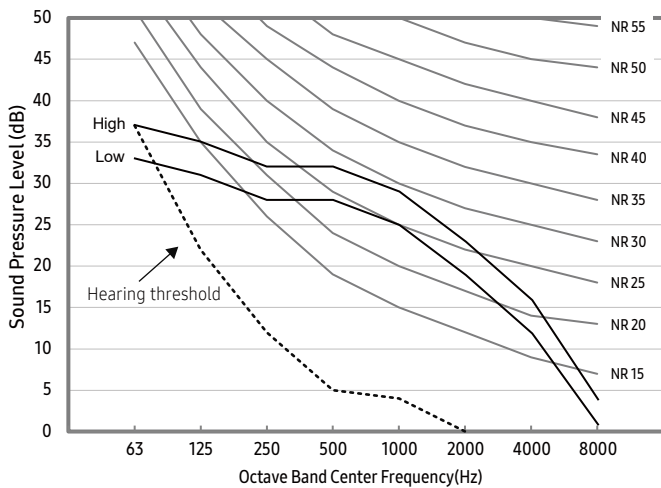

2) AM045KNJDEH/EU

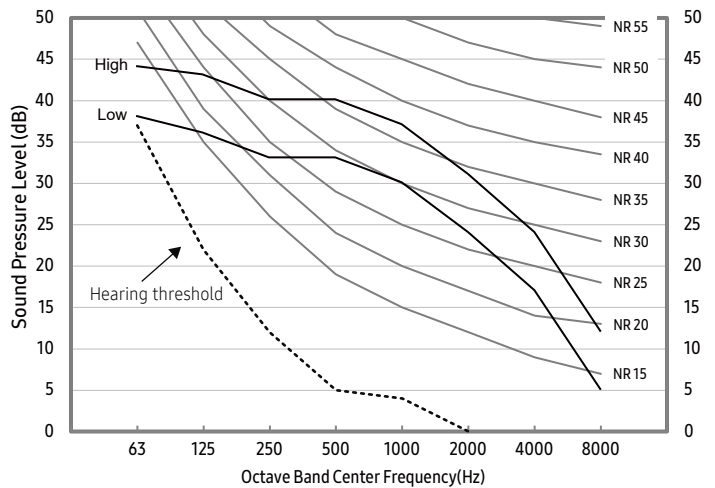

5 Sound Pressure Level

Console

Unit: dB(A)

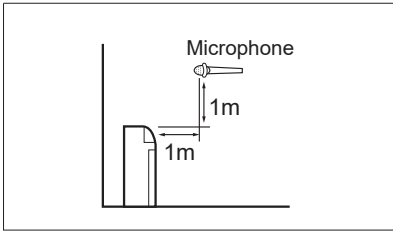

Model	High	Low
AM028FNJDEH/EU	38	34
AM036FNJDEH/EU	39	34
AM056FNJDEH/EU	43	37

Note

Specifications may be subject to change without prior notice.
 Sound pressure level is obtained in an anechoic room.
 Sound pressure level is a relative value, depending on the distance and acoustic environment.
 Sound pressure level may differ depending on operation condition.
 dBA = A-weighted sound pressure level
 Reference acoustic pressure 0 dB= 20 uPa

NR curve

1) AM028FNJDEH/EU

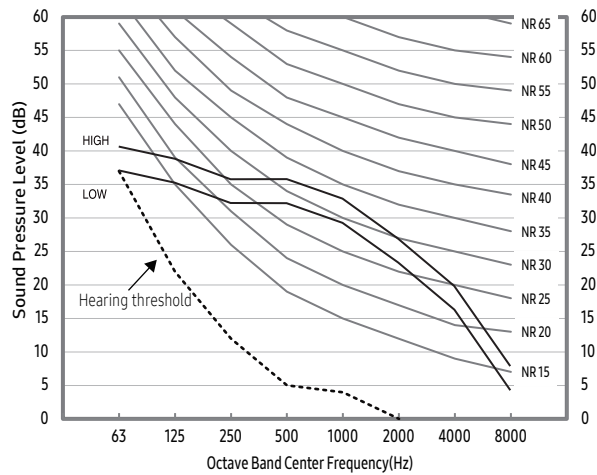

2) AM036FNJDEH/EU

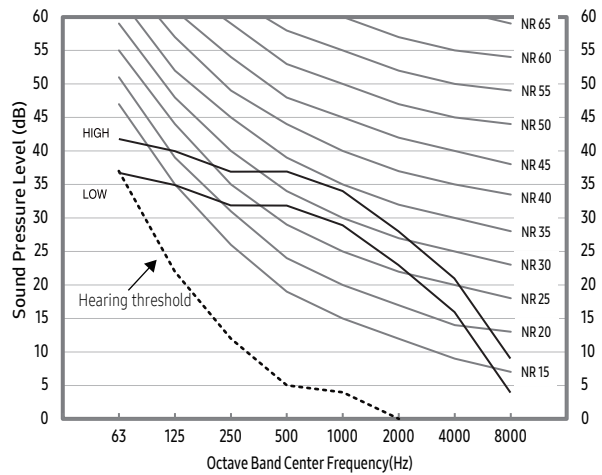

3) AM056FNJDEH/EU

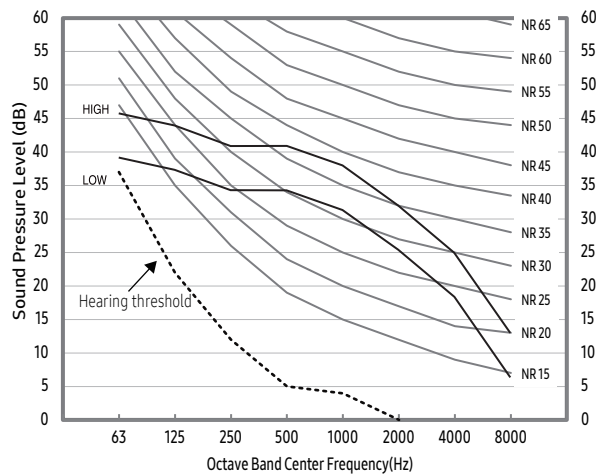

6 Sound Power Level

Console

Note

- . Specifications may be subject to change without prior notice.
- . Sound power level is an absolute value that a sound source generates.
- . dBA = A-weighted sound power level.
- . Reference power : 1pW.
- . Measured according to ISO 3741

Unit: dB(A)

Model	Power
AM022KNJDEH/EU	52
AM028FNJDEH/EU	58
AM036FNJDEH/EU	59
AM045KNJDEH/EU	63
AM056FNJDEH/EU	64

1) AM022KNJDEH/EU

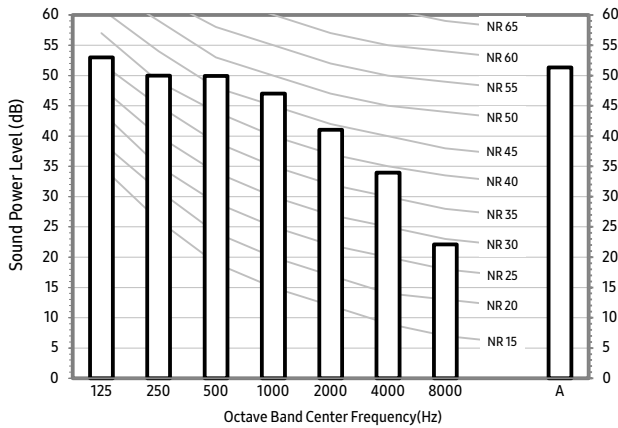

2) AM028FNJDEH/EU

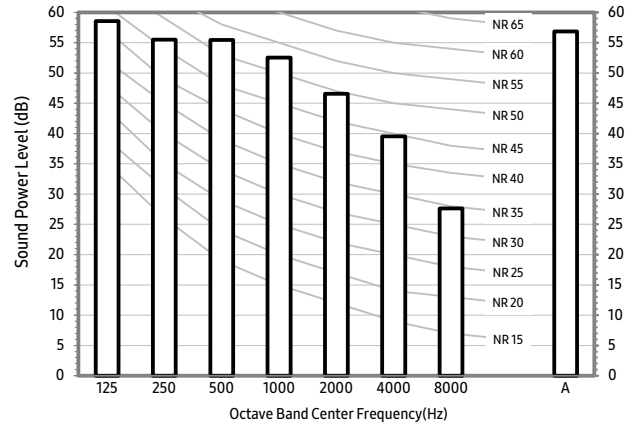

3) AM036FNJDEH/EU

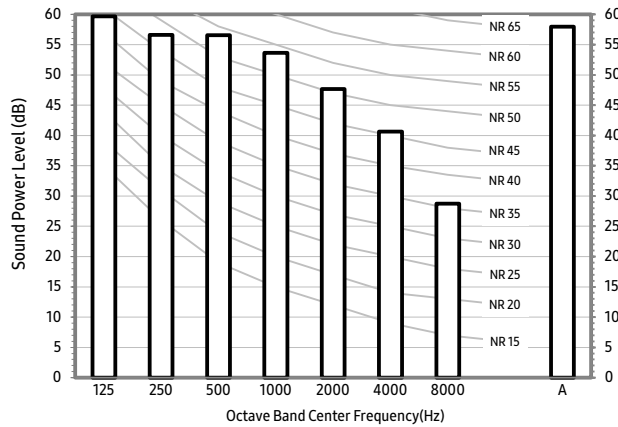

4) AM045KNJDEH/EU

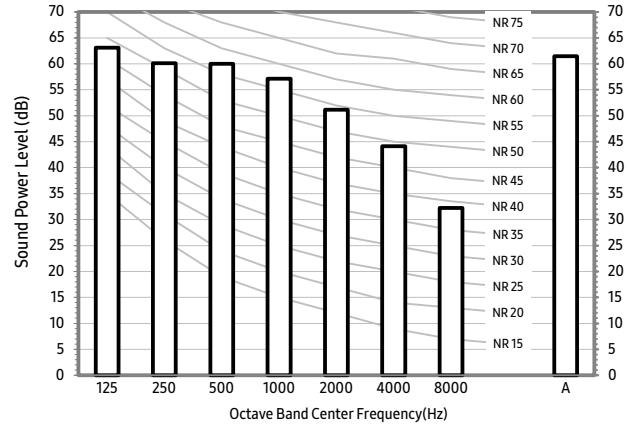

5) AM056FNJDEH/EU

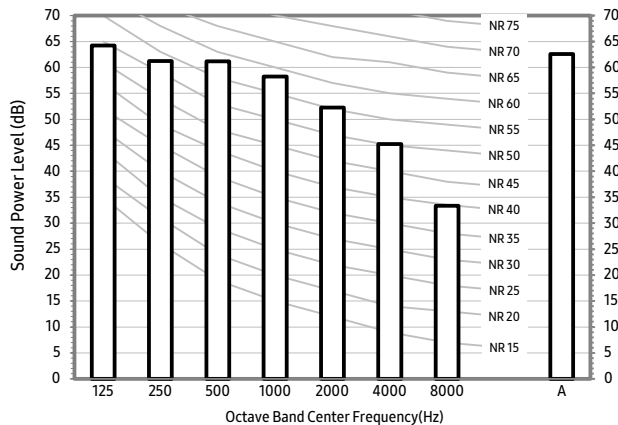

7 Temperature and air flow distribution

Console

AM022KNJDEH/EU

(1) Cooling air velocity distribution

Discharge angle (Default) : 40°

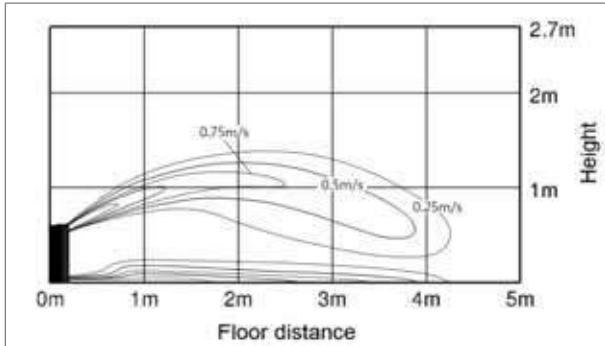

(2) Cooling temperature distribution

Discharge angle (Default) : 40°

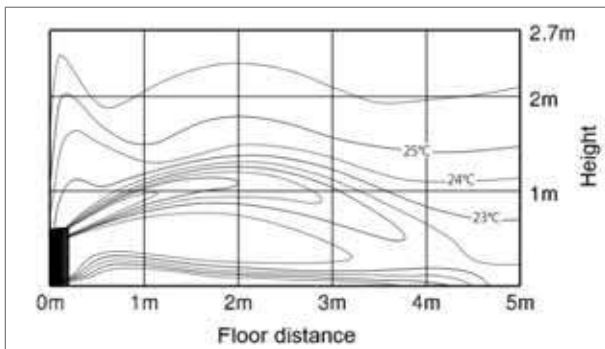

(3) Heating air velocity distribution

Discharge angle (Default) : 40°

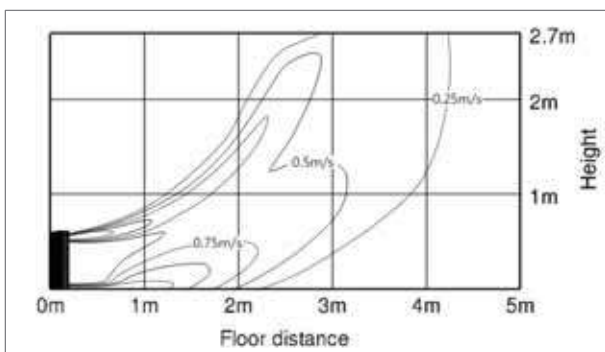

(4) Heating temperature distribution

Discharge angle (Default) : 40°

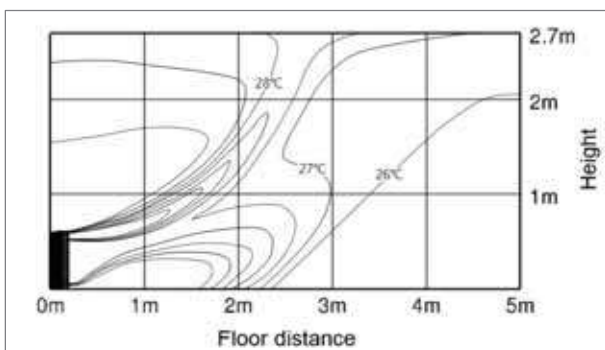

7 Temperature and air flow distribution

Console

AM028FNJDEH/EU

(1) Cooling air velocity distribution

Discharge angle (Default) : 40°

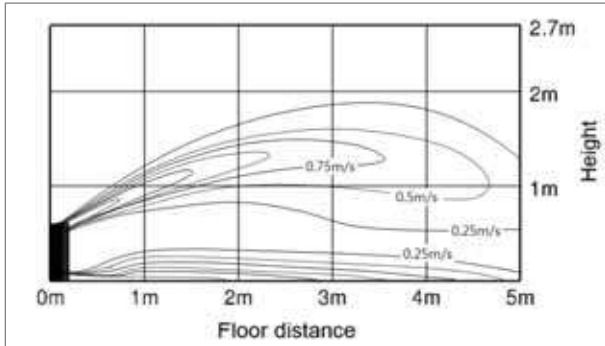

(2) Cooling temperature distribution

Discharge angle (Default) : 40°

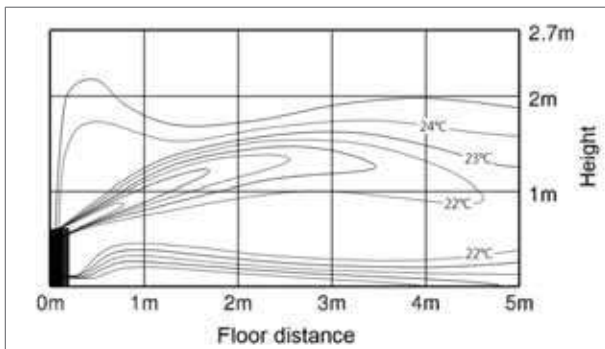

(3) Heating air velocity distribution

Discharge angle (Default) : 40°

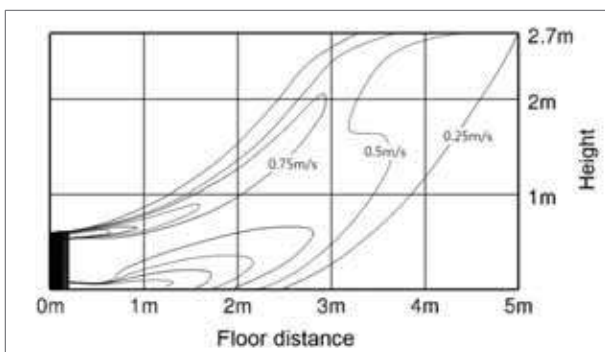

(4) Heating temperature distribution

Discharge angle (Default) : 40°

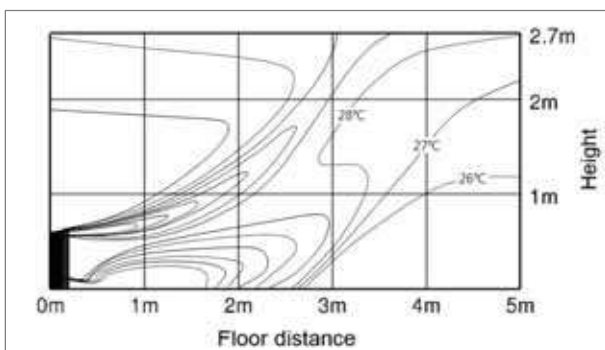

7 Temperature and air flow distribution

Console

AM036FNJDEH/EU

(1) Cooling air velocity distribution

Discharge angle (Default) : 40°

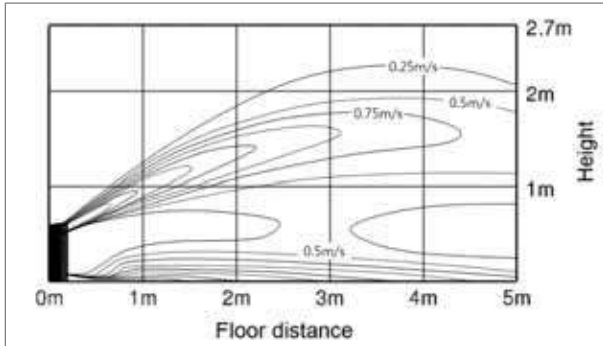

(2) Cooling temperature distribution

Discharge angle (Default) : 40°

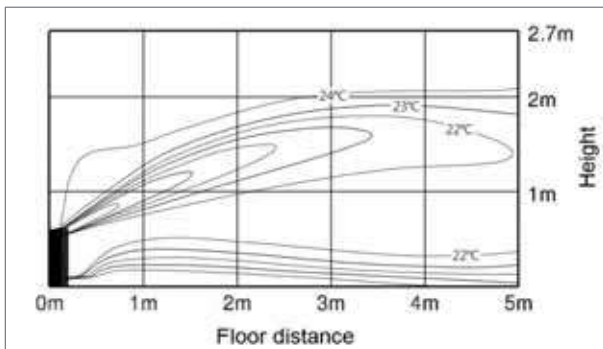

(3) Heating air velocity distribution

Discharge angle (Default) : 4°

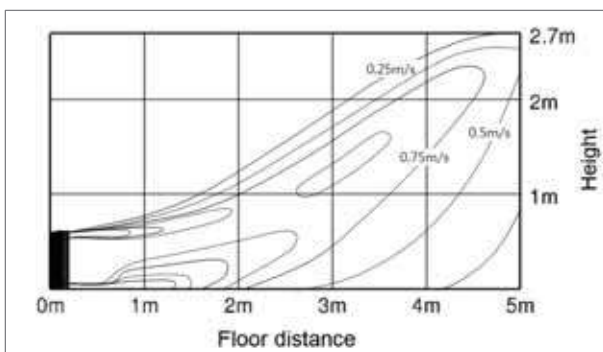

(4) Heating temperature distribution

Discharge angle (Default) : 4°

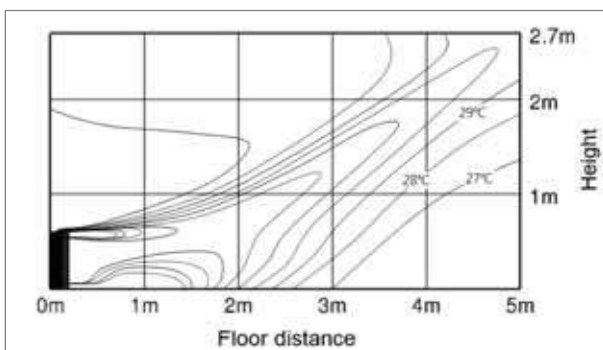

7 Temperature and air flow distribution

Console

AM045KNJDEH/EU

(1) Cooling air velocity distribution

Discharge angle (Default) : 40°

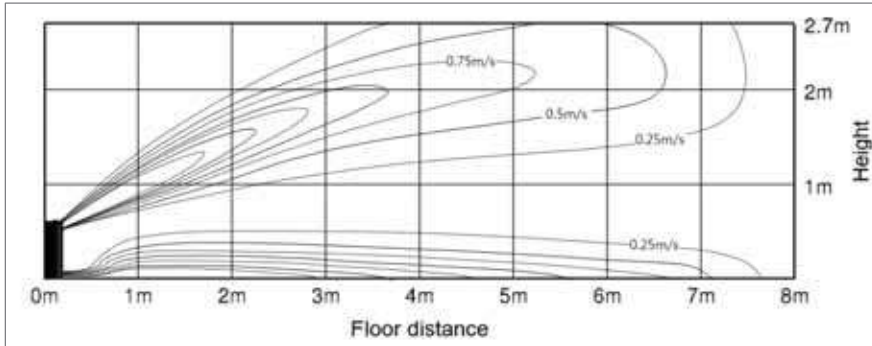

(2) Cooling temperature distribution

Discharge angle (Default) : 40°

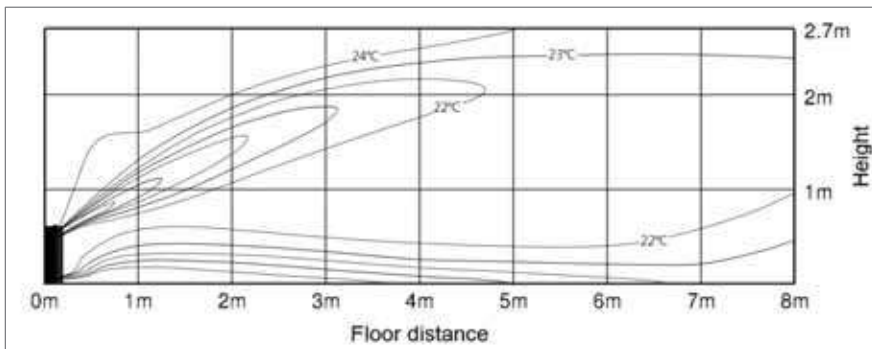

(3) Heating air velocity distribution

Discharge angle (Default) : 4°

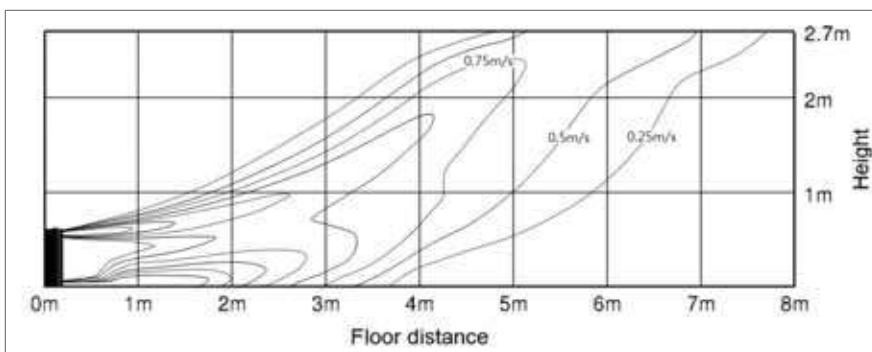

(4) Heating temperature distribution

Discharge angle (Default) : 4°

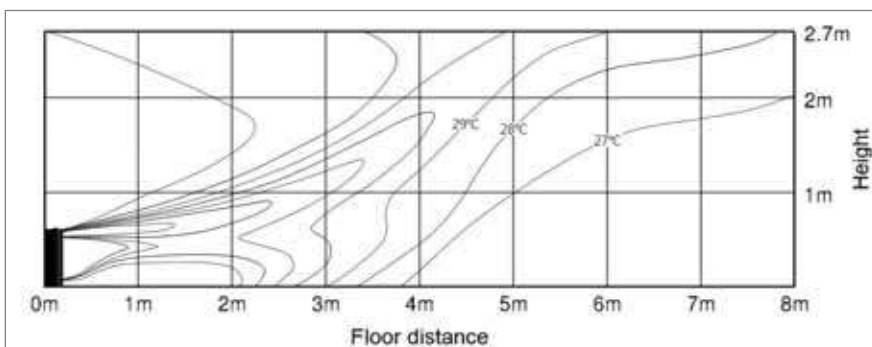

7 Temperature and air flow distribution

Console

AM056FNJDEH/EU

(1) Cooling air velocity distribution

Discharge angle (Default) : 40°

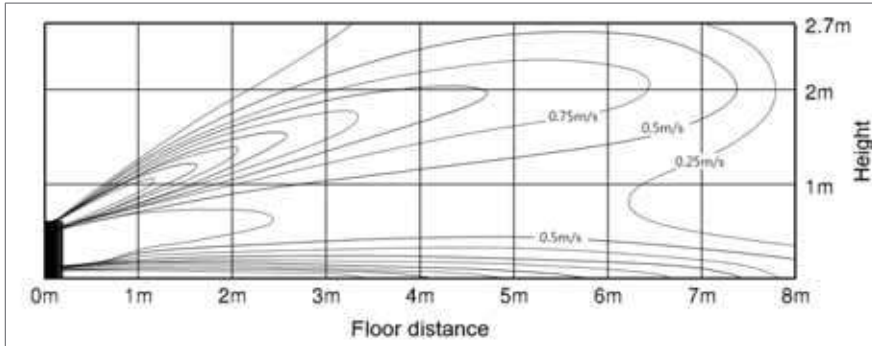

(2) Cooling temperature distribution

Discharge angle (Default) : 40°

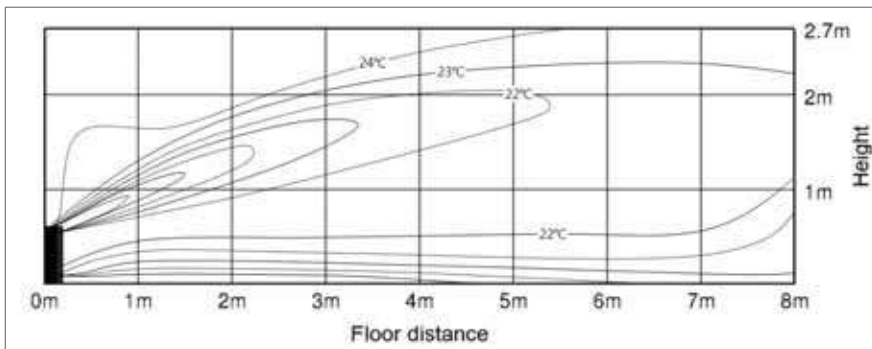

(3) Heating air velocity distribution

Discharge angle (Default) : 4°

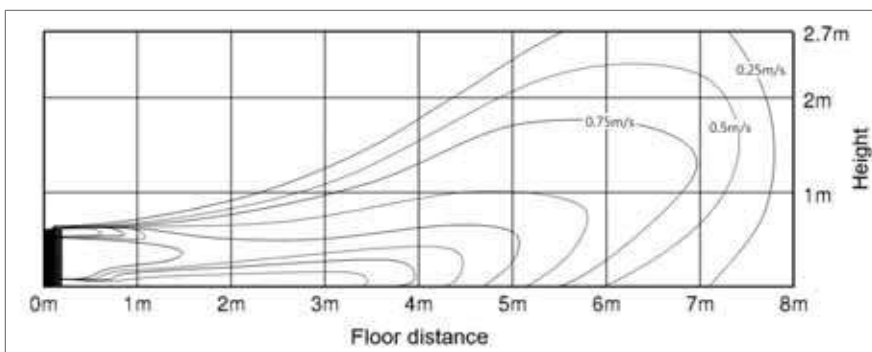

(4) Heating temperature distribution

Discharge angle (Default) : 4°

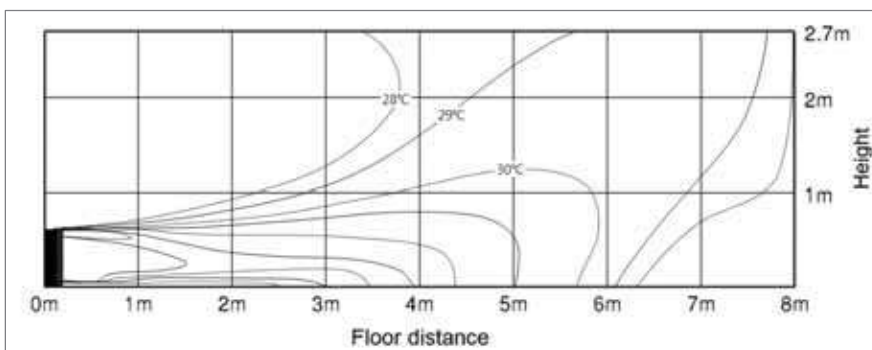

Floor Standing

- 1 *Specifications*
- 2 *Capacity Table*
- 3 *Dimensional Drawing*
- 4 *Electrical Wiring Diagram*
- 5 *Sound Pressure Level*
- 6 *Temperature and air flow distribution*

1 Specifications

Floor Standing

1) Technical specifications

Model				AM036FNFDEH***	AM056FNFDEH***	AM071FNFDEH***
Power Supply		Ø, #, V, Hz		1, 2, 220~240, 50	1, 2, 220~240, 50	1, 2, 220~240, 50
Mode *1)				HP/HR	HP/HR	HP/HR
Performance	Capacity (Nominal)	Cooling *2)	kW	3.6	5.6	7.1
			Btu/h	12,300	19,100	24,200
		Heating *3)	kW	4.0	6.3	8.0
			Btu/h	13,600	21,500	27,300
Power	Power Input (Nominal)	Cooling *2)	W	50	110	110
		Heating *3)		50	110	110
	Current Input (Nominal)	Cooling *2)	A	0.24	0.53	0.53
		Heating *3)		0.24	0.53	0.53
Fan	Motor	Type	-	Sirocco Fan	Sirocco Fan	Sirocco Fan
		Output	W	-	-	-
		Number of unit	EA	-	-	-
	Air Flow Rate	H/M/L (UL)	CMM	10.00/8.50/6.00	15.50/14.00/11.00	15.50/14.00/11.00
			l/s	166.67/141.67/100.00	258.33/233.33/183.33	258.33/233.33/183.33
	External Pressure	Min / Std / Max	mmAq	-	-	-
			Pa	-	-	-
WG			-	-	-	
Option Code				01A054-105000-202424-330010	01A054-105000-203838-330010	01A054-105000-204747-330010
Piping Connections	Liquid Pipe	Ø, mm	6.35	6.35	9.52	
		Ø, inch	1/4	1/4	3/8	
	Gas Pipe	Ø, mm	12.70	12.70	15.88	
		Ø, inch	1/2	1/2	5/8	
	Drain Pipe	Ø, mm	ID 18 HOSE	ID 18 HOSE	ID 18 HOSE	
Field Wiring	Power Source Wire	Below 20m / over 20m	mm ²	1.5 / 2.5	1.5 / 2.5	1.5 / 2.5
	Transmission Cable		mm ²	0.75~1.5	0.75~1.5	0.75~1.5
Refrigerant	Type		-	R410A	R410A	R410A
	Control Method		-	EEV INCLUDED	EEV INCLUDED	EEV INCLUDED
Sound	Sound Pressure	High / Mid / Low *4)	dBA	37 / 32 / 27	40 / 36 / 32	40 / 36 / 32
Dimensions	Net Weight		kg	23.0	28.5	28.5
	Shipping Weight		kg	27.0	33.3	33.3
	Net Dimensions (W×H×D)		mm	945 x 600 x 220	1225 x 600 x 220	1225 x 600 x 220
	Shipping Dimensions (W×H×D)		mm	1035 x 690 x 310	1335 x 690 x 310	1335 x 690 x 310
Panel Size	Panel model		-	-	-	-
	Panel Net Weight		kg	-	-	-
	Shipping Weight		kg	-	-	-
	Net Dimensions (W×H×D)		mm	-	-	-
	Shipping Dimensions (W×H×D)		mm	-	-	-
Additional Accessories	Drain pump	Drain pump	- / Model	-	-	-
		Max. lifting Height / Displacement	mm/liter/h	-	-	-
	Air Filter		-	Long life filter	Long life filter	Long life filter

* Specifications may be subject to change without prior notice for product improvement.

*1) Mode

- HP : Heat Pump, HR : Heat Recovery

*2) Nominal cooling capacities are based on;

- Indoor temperature : 27°C DB, 19°C WB

- Outdoor temperature : 35°C DB, 24°C WB, Equivalent refrigerant piping : 7.5m, Level differences : 0m

*3) Nominal heating capacities are based on;

- Indoor temperature : 20°C DB, 15°C WB

- Outdoor temperature : 7°C DB, 6°C WB, Equivalent refrigerant piping : 7.5m, Level differences : 0m

*4) Sound pressure was acquired in an anechoic room. Thus actual noise level may be different depending on the installation conditions.

*5) These products contain R410A which is fluorinated greenhouse gas.

* Heat Exchanger type : Fin & Tube (Fin : Al, Tube : Cu)

2 Capacity table

Floor Standing

1) Cooling

TC : Total Capacity(kW), SHC : Sensible Heat Capacity(kW)

Capacity Index	Outdoor Air Temp. (°C,DB)	Indoor temperature													
		20(°C,DB)		23(°C,DB)		26(°C,DB)		27(°C,DB)		28(°C,DB)		30(°C,DB)		32(°C,DB)	
		14(°C,WB)		16(°C,WB)		18(°C,WB)		19(°C,WB)		20(°C,WB)		22(°C,WB)		24(°C,WB)	
		TC	SHC	TC	SHC	TC	SHC	TC	SHC	TC	SHC	TC	SHC	TC	SHC
036	10	2.5	2.0	2.9	2.3	3.4	2.5	3.6	2.6	3.7	2.6	4.0	2.6	4.3	2.5
	12	2.5	2.0	2.9	2.3	3.4	2.5	3.6	2.6	3.7	2.6	4.0	2.6	4.3	2.5
	14	2.5	2.0	2.9	2.3	3.4	2.5	3.6	2.6	3.7	2.6	4.0	2.6	4.3	2.5
	16	2.5	2.0	2.9	2.3	3.4	2.5	3.6	2.6	3.7	2.6	4.0	2.6	4.3	2.5
	18	2.5	2.0	2.9	2.3	3.4	2.5	3.6	2.6	3.7	2.6	4.0	2.6	4.2	2.4
	20	2.5	2.0	2.9	2.3	3.4	2.5	3.6	2.6	3.7	2.6	4.0	2.6	4.2	2.4
	21	2.5	2.0	2.9	2.3	3.4	2.5	3.6	2.6	3.7	2.6	4.0	2.6	4.2	2.4
	23	2.5	2.0	2.9	2.3	3.4	2.5	3.6	2.6	3.7	2.6	4.0	2.6	4.2	2.4
	25	2.5	2.0	2.9	2.3	3.4	2.5	3.6	2.6	3.7	2.6	4.0	2.6	4.2	2.4
	27	2.5	2.0	2.9	2.3	3.4	2.5	3.6	2.6	3.7	2.6	4.0	2.6	4.2	2.4
	29	2.5	2.0	2.9	2.3	3.4	2.5	3.6	2.6	3.7	2.6	4.0	2.6	4.2	2.4
	31	2.5	2.0	2.9	2.3	3.4	2.5	3.6	2.6	3.7	2.6	4.0	2.6	4.2	2.4
	33	2.5	2.0	2.9	2.3	3.4	2.5	3.6	2.6	3.7	2.6	4.0	2.6	4.2	2.4
	35	2.5	2.0	2.9	2.3	3.4	2.5	3.6	2.6	3.7	2.6	4.0	2.6	4.2	2.4
	37	2.5	2.0	2.9	2.3	3.4	2.5	3.6	2.6	3.7	2.6	3.9	2.5	4.2	2.4
	39	2.5	2.0	2.9	2.3	3.4	2.5	3.6	2.6	3.7	2.6	3.9	2.5	4.1	2.3
42	2.5	2.0	2.9	2.3	3.4	2.5	3.6	2.6	3.7	2.6	3.8	2.5	4.0	2.2	
44	2.5	2.0	2.9	2.3	3.3	2.4	3.4	2.5	3.6	2.5	3.7	2.4	3.9	2.2	
46	2.5	2.0	2.9	2.3	3.2	2.4	3.3	2.4	3.4	2.4	3.6	2.3	3.8	2.1	
48	2.5	2.0	2.8	2.2	3.2	2.3	3.2	2.3	3.4	2.4	3.5	2.2	3.6	2.0	
056	10	3.9	3.3	4.6	3.8	5.3	4.0	5.6	4.2	5.8	4.2	6.3	4.3	6.7	4.1
	12	3.9	3.3	4.6	3.8	5.3	4.0	5.6	4.2	5.8	4.2	6.3	4.3	6.7	4.1
	14	3.9	3.3	4.6	3.8	5.3	4.0	5.6	4.2	5.8	4.2	6.2	4.2	6.7	4.1
	16	3.9	3.3	4.6	3.8	5.3	4.0	5.6	4.2	5.8	4.2	6.2	4.2	6.6	4.0
	18	3.9	3.3	4.6	3.8	5.3	4.0	5.6	4.2	5.8	4.2	6.2	4.2	6.6	4.0
	20	3.9	3.3	4.6	3.8	5.3	4.0	5.6	4.2	5.8	4.2	6.2	4.2	6.6	4.0
	21	3.9	3.3	4.6	3.8	5.3	4.0	5.6	4.2	5.8	4.2	6.2	4.2	6.6	4.0
	23	3.9	3.3	4.6	3.8	5.3	4.0	5.6	4.2	5.8	4.2	6.2	4.2	6.6	4.0
	25	3.9	3.3	4.6	3.8	5.3	4.0	5.6	4.2	5.8	4.2	6.2	4.2	6.6	4.0
	27	3.9	3.3	4.6	3.8	5.3	4.0	5.6	4.2	5.8	4.2	6.2	4.2	6.6	4.0
	29	3.9	3.3	4.6	3.8	5.3	4.0	5.6	4.2	5.8	4.2	6.2	4.2	6.6	4.0
	31	3.9	3.3	4.6	3.8	5.3	4.0	5.6	4.2	5.8	4.2	6.2	4.2	6.6	4.0
	33	3.9	3.3	4.6	3.8	5.3	4.0	5.6	4.2	5.8	4.2	6.2	4.2	6.6	4.0
	35	3.9	3.3	4.6	3.8	5.3	4.0	5.6	4.2	5.8	4.2	6.2	4.2	6.6	4.0
	37	3.9	3.3	4.6	3.8	5.3	4.0	5.6	4.2	5.8	4.2	6.1	4.1	6.5	3.9
	39	3.9	3.3	4.6	3.8	5.3	4.0	5.6	4.2	5.8	4.2	6.1	4.1	6.4	3.8
42	3.9	3.3	4.6	3.8	5.3	4.0	5.5	4.1	5.7	4.2	6.0	4.0	6.2	3.7	
44	3.9	3.3	4.6	3.8	5.1	3.9	5.3	4.0	5.6	4.0	5.8	3.9	6.0	3.6	
46	3.9	3.3	4.6	3.7	5.0	3.8	5.2	3.9	5.4	3.9	5.6	3.7	5.9	3.5	
48	3.9	3.2	4.5	3.7	5.0	3.7	5.0	3.8	5.3	3.8	5.4	3.6	5.7	3.3	
071	10	4.9	4.3	5.8	5.0	6.7	5.2	7.1	5.4	7.4	5.6	8.0	5.7	8.5	5.4
	12	4.9	4.3	5.8	5.0	6.7	5.2	7.1	5.4	7.4	5.6	7.9	5.6	8.5	5.4
	14	4.9	4.3	5.8	5.0	6.7	5.2	7.1	5.4	7.4	5.6	7.9	5.6	8.5	5.4
	16	4.9	4.3	5.8	5.0	6.7	5.2	7.1	5.4	7.4	5.6	7.9	5.6	8.4	5.3
	18	4.9	4.3	5.8	5.0	6.7	5.2	7.1	5.4	7.4	5.6	7.9	5.6	8.4	5.3
	20	4.9	4.3	5.8	5.0	6.7	5.2	7.1	5.4	7.4	5.6	7.9	5.6	8.4	5.3
	21	4.9	4.3	5.8	5.0	6.7	5.2	7.1	5.4	7.4	5.6	7.9	5.6	8.4	5.3
	23	4.9	4.3	5.8	5.0	6.7	5.2	7.1	5.4	7.4	5.6	7.9	5.6	8.4	5.3
	25	4.9	4.3	5.8	5.0	6.7	5.2	7.1	5.4	7.4	5.6	7.9	5.6	8.4	5.3
	27	4.9	4.3	5.8	5.0	6.7	5.2	7.1	5.4	7.4	5.6	7.9	5.6	8.4	5.3
	29	4.9	4.3	5.8	5.0	6.7	5.2	7.1	5.4	7.4	5.6	7.9	5.6	8.4	5.3
	31	4.9	4.3	5.8	5.0	6.7	5.2	7.1	5.4	7.4	5.6	7.9	5.6	8.4	5.3
	33	4.9	4.3	5.8	5.0	6.7	5.2	7.1	5.4	7.4	5.6	7.9	5.6	8.4	5.3
	35	4.9	4.3	5.8	5.0	6.7	5.2	7.1	5.4	7.4	5.6	7.9	5.6	8.4	5.3
	37	4.9	4.3	5.8	5.0	6.7	5.2	7.1	5.4	7.3	5.5	7.8	5.5	8.2	5.2
	39	4.9	4.3	5.8	5.0	6.7	5.2	7.1	5.4	7.3	5.5	7.7	5.4	8.1	5.1
42	4.9	4.3	5.8	5.0	6.7	5.2	7.0	5.3	7.2	5.4	7.6	5.3	7.9	5.0	
44	4.9	4.3	5.8	5.0	6.5	5.0	6.8	5.2	7.0	5.3	7.3	5.1	7.6	4.8	
46	4.9	4.3	5.7	5.0	6.4	4.9	6.6	5.0	6.8	5.1	7.0	4.9	7.4	4.7	
48	4.8	4.2	5.7	4.9	6.3	4.9	6.4	4.9	6.7	5.0	6.8	4.8	7.2	4.5	

2 Capacity table

Floor Standing

2) Heating

TC : Total Capacity(kW)

Capacity Index	Outdoor Air Temp. (°C)		Indoor temperature (°C,DB)				
			16(°C,DB)	18(°C,DB)	20(°C,DB)	22(°C,DB)	24(°C,DB)
	DB	WB	TC kW	TC kW	TC kW	TC kW	TC kW
036	-19.8	-20.0	2.4	2.4	2.3	2.3	2.3
	-18.8	-19.0	2.5	2.4	2.3	2.3	2.3
	-16.7	-17.0	2.6	2.5	2.4	2.4	2.3
	-14.7	-15.0	2.7	2.6	2.5	2.5	2.4
	-12.6	-13.0	2.8	2.7	2.7	2.6	2.6
	-10.5	-11.0	2.9	2.9	2.9	2.8	2.8
	-9.5	-10.0	2.9	2.9	2.9	2.8	2.8
	-8.5	-9.1	3.0	3.0	3.0	2.9	2.9
	-7.0	-7.6	3.1	3.1	3.0	3.0	2.9
	-5.0	-5.6	3.3	3.2	3.2	3.1	3.0
	-3.0	-3.7	3.4	3.4	3.3	3.2	3.1
	0.0	-0.7	3.6	3.6	3.5	3.4	3.2
	3.0	2.2	3.8	3.7	3.7	3.5	3.4
	5.0	4.1	3.9	3.9	3.8	3.6	3.4
	7.0	6.0	4.1	4.1	4.0	3.7	3.4
056	9.0	7.9	4.2	4.1	4.0	3.7	3.4
	11.0	9.8	4.4	4.2	4.0	3.7	3.4
	13.0	11.8	4.5	4.2	4.0	3.7	3.4
	15.0	13.7	4.6	4.3	4.0	3.7	3.4
	-19.8	-20.0	3.9	3.8	3.8	3.7	3.7
	-18.8	-19.0	3.9	3.9	3.8	3.7	3.7
	-16.7	-17.0	4.0	4.0	3.9	3.8	3.8
	-14.7	-15.0	4.2	4.1	4.0	3.9	3.8
	-12.6	-13.0	4.4	4.3	4.2	4.1	4.0
	-10.5	-11.0	4.6	4.5	4.4	4.4	4.3
	-9.5	-10.0	4.7	4.6	4.6	4.5	4.4
	-8.5	-9.1	4.8	4.7	4.7	4.6	4.5
	-7.0	-7.6	4.9	4.8	4.8	4.7	4.5
	-5.0	-5.6	5.2	5.1	5.0	4.9	4.7
	-3.0	-3.7	5.4	5.3	5.3	5.1	4.9
0.0	-0.7	5.7	5.6	5.5	5.3	5.0	
071	3.0	2.2	5.9	5.9	5.8	5.6	5.3
	5.0	4.1	6.2	6.1	6.0	5.7	5.3
	7.0	6.0	6.5	6.4	6.3	5.8	5.3
	9.0	7.9	6.7	6.5	6.3	5.8	5.3
	11.0	9.8	6.9	6.6	6.3	5.8	5.3
	13.0	11.8	7.1	6.7	6.3	5.8	5.3
	15.0	13.7	7.3	6.8	6.3	5.8	5.3
	-19.8	-20.0	4.9	4.9	4.8	4.7	4.7
	-18.8	-19.0	5.0	4.9	4.8	4.7	4.7
	-16.7	-17.0	5.1	5.0	4.9	4.8	4.8
	-14.7	-15.0	5.3	5.2	5.1	4.9	4.8
	-12.6	-13.0	5.5	5.4	5.3	5.2	5.1
	-10.5	-11.0	5.8	5.7	5.6	5.5	5.5
	-9.5	-10.0	6.0	5.9	5.8	5.7	5.6
	-8.5	-9.1	6.1	6.0	5.9	5.8	5.7
-7.0	-7.6	6.2	6.1	6.0	5.9	5.8	
-5.0	-5.6	6.5	6.5	6.4	6.2	6.0	
-3.0	-3.7	6.9	6.8	6.7	6.4	6.2	
0.0	-0.7	7.2	7.1	7.0	6.7	6.4	
3.0	2.2	7.6	7.5	7.3	7.1	6.8	
5.0	4.1	7.9	7.8	7.7	7.2	6.8	
7.0	6.0	8.2	8.1	8.0	7.4	6.8	
9.0	7.9	8.5	8.2	8.0	7.4	6.8	
11.0	9.8	8.7	8.4	8.0	7.4	6.8	
13.0	11.8	9.0	8.5	8.0	7.4	6.8	
15.0	13.7	9.2	8.6	8.0	7.4	6.8	

3 Dimensional drawing

Floor Standing

Unit:mm

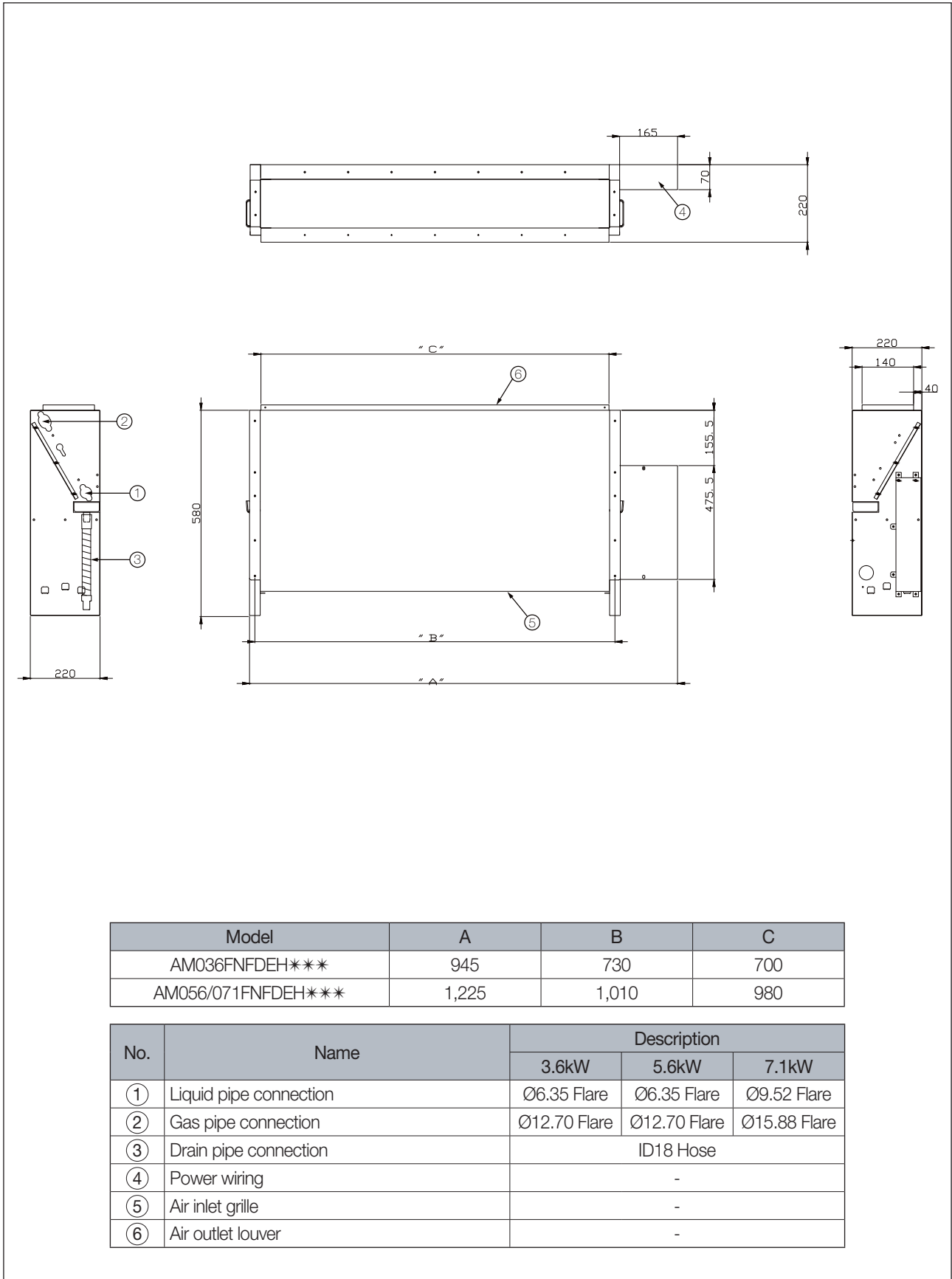

4 Electrical Wiring Diagram

Floor Standing

AM036/056/071FNFDEH/EU

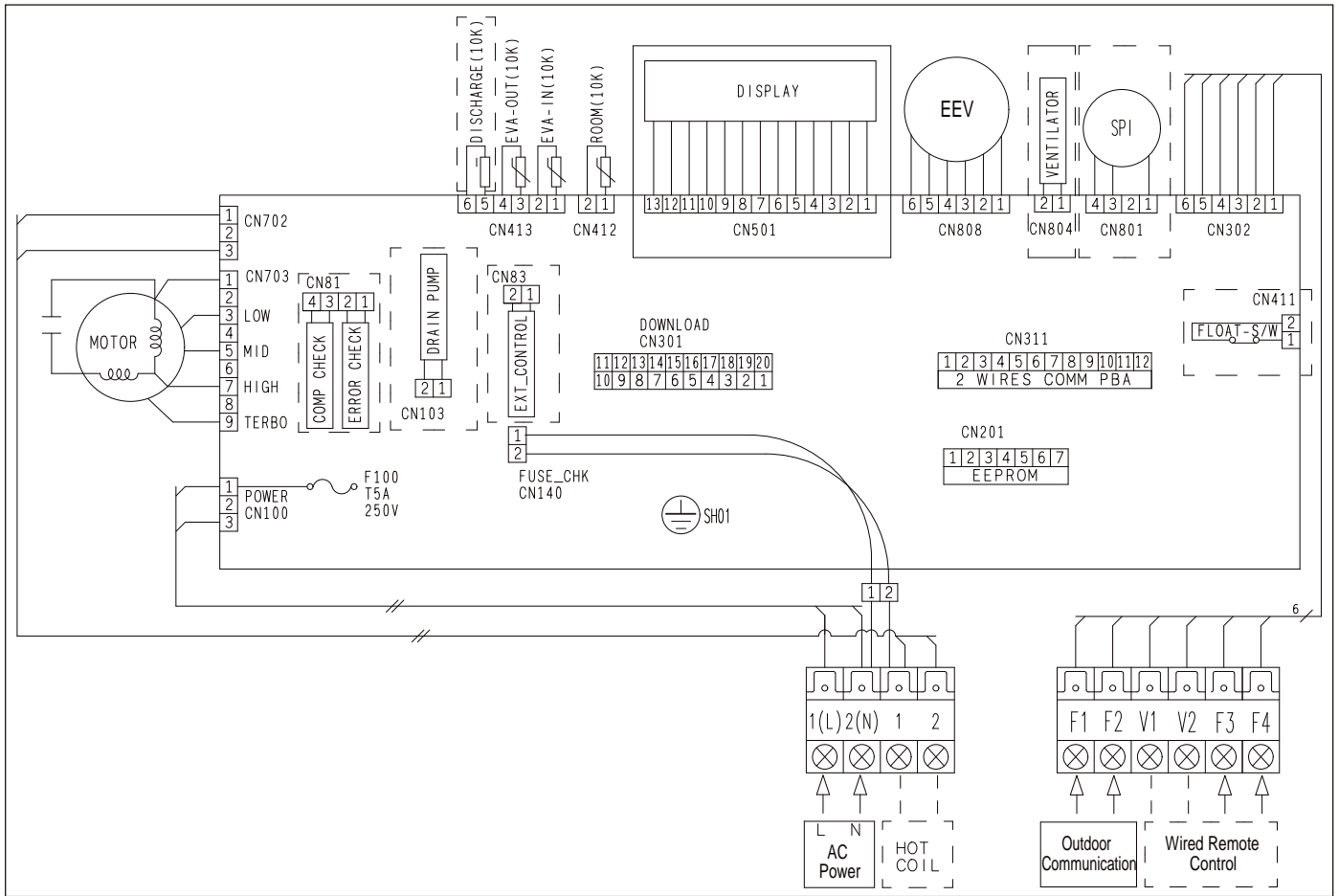

NOTE

1. This wiring diagram applies only to the indoor unit.
2. Symbols show as follow;
BLK : black, RED : red, BLU : blue, WHT:white, YEL : yellow, BRN : brown, SKY : sky-blue, GRN : green
3. For connection wiring indoor-outdoor transmission F1-F2, indoor-wired remotecontroller transmission F3-F4.
4. : Protective earth(screw), : Connector, n : The wire quantity

5 Sound Pressure Level

Floor Standing

Unit: dB(A)

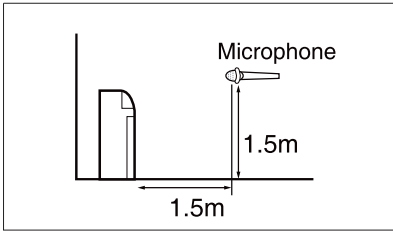

Model	High	Low
AM036FNFDEH/EU	37	27
AM056FNFDEH/EU	40	32
AM071FNFDEH/EU	40	32

Note

Specifications may be subject to change without prior notice.
 Sound pressure level is obtained in an anechoic room.
 Sound pressure level is a relative value, depending on the distance and acoustic environment.
 Sound pressure level may differ depending on operation condition.
 dBA = A-weighted sound pressure level
 Reference acoustic pressure 0 dB= 20 uPa

NR curve

1) AM036FNFDEH/EU

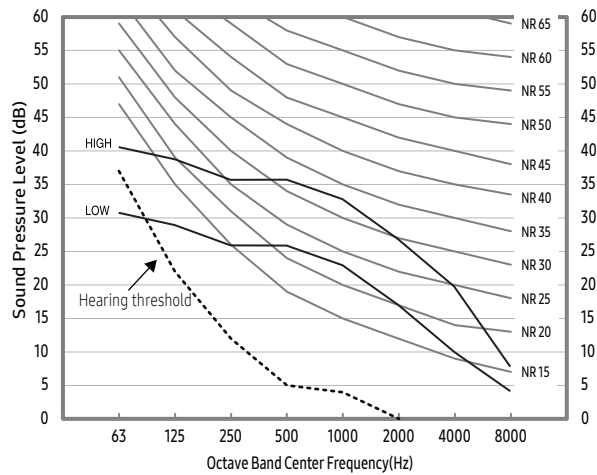

2) AM056FNFDEH/EU

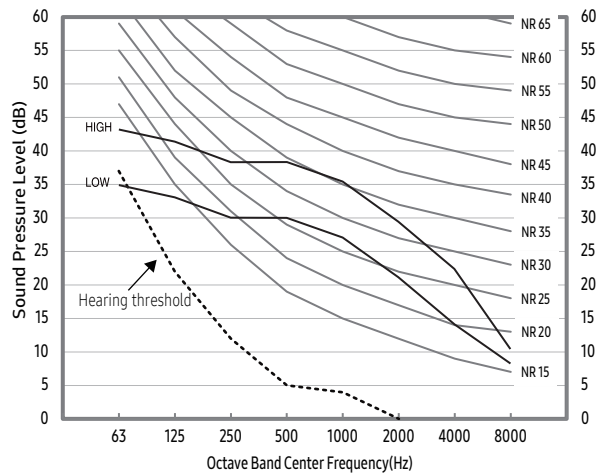

2) AM071FNFDEH/EU

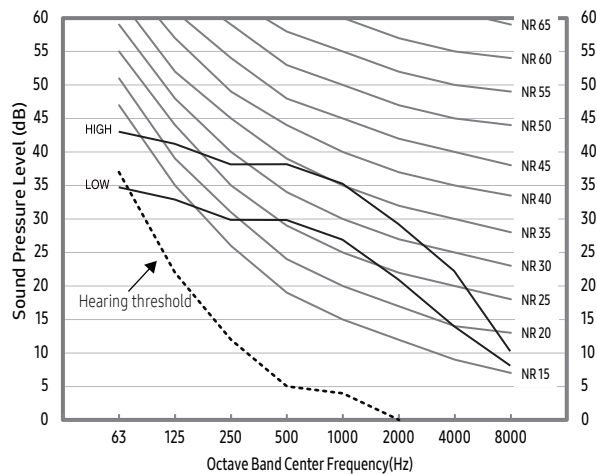

6 Temperature and air flow distribution

Floor Standing

AM036FNFDEH/EU

(1) Cooling air velocity distribution

Discharge angle : 36°

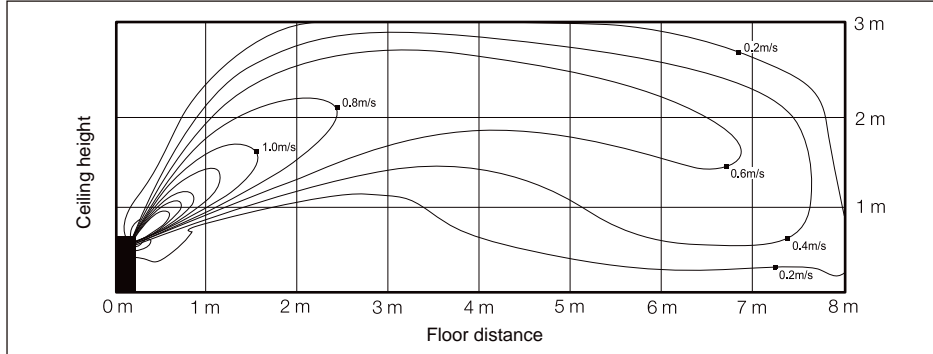

(2) Cooling temperature distribution

Discharge angle : 36°

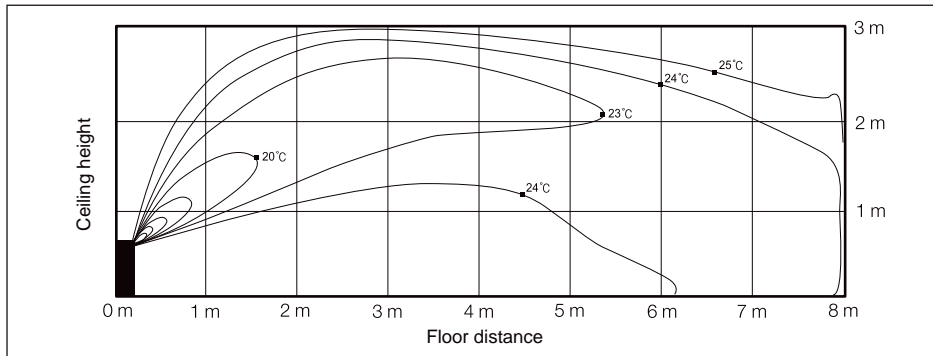

(3) Heating air velocity distribution

Discharge angle : 54°

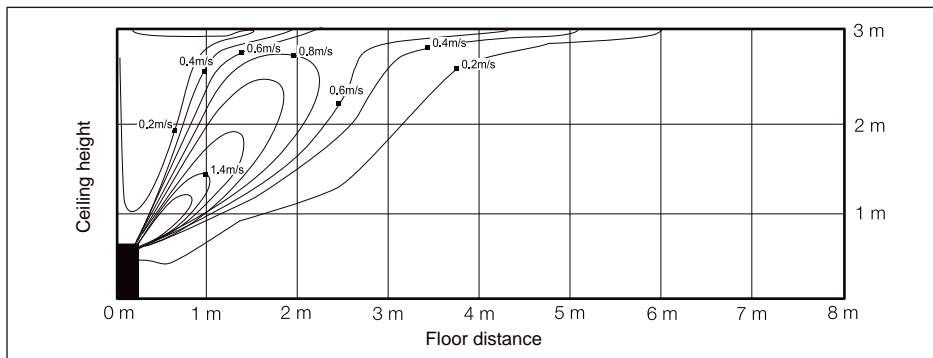

(4) Heating temperature distribution

Discharge angle : 54°

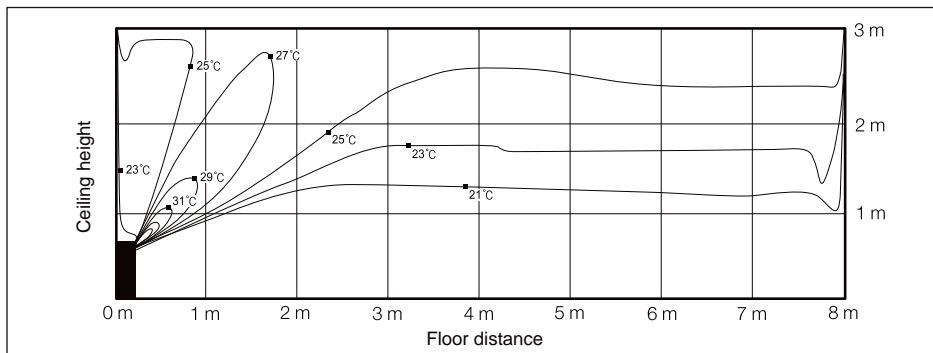

PAC

- 1 *Specifications*
- 2 *Capacity Table*
- 3 *Dimensional Drawing*
- 4 *Electrical Wiring Diagram*
- 5 *Sound Pressure Level*

1 Specifications

PAC

Type			PAC	PAC	
Model			AM140JNPDKH/TK	AM280JNPDKH/TK	
Power Supply		Ø, #, V, Hz	1,2,220-240,50/60	1,2,220-240,50	
Mode			HP/HR	HP/HR	
Performance	Capacity (Nominal)	Cooling	kW	14.00	28.00
			Btu/h	47,800	95,500
		Heating	kW	16.00	31.50
			Btu/h	54,600	107,500
Power	Power Input (Nominal)	Cooling	W	190.00	955.00
		Heating	W	190.00	955.00
	Current Input (Nominal)	Cooling	A	0.90	4.73
		Heating	A	0.90	4.73
Fan	Motor	Type	-	Sirocco Fan	Sirocco Fan
		Output x n	w	154 x 1	700 x 1
	Air Flow Rate	H/M/L (UL)	CMM	35.00 / 30.50 / 27.50	70.00 / 60.00 / 50.00
			l/s	583.33 / 508.33 / 458.33	1,166.67 / 1,000.00 / 833.33
	External Pressure	Min/Std/Max	mmAq	-	-
Pa			-	-	
Piping Connections	Liquid Pipe	Ø, mm	9.52	9.52	
		Ø, inch	3/8"	3/8"	
	Gas Pipe	Ø, mm	15.88	22.22	
		Ø, inch	5/8"	7/8"	
Drain Pipe	Ø, mm	ID18 HOSE	VP25 (OD 32, ID 25)		
Field Wiring	Power Source Wire	mm ²	2.5	2.5	
	Transmission Cable	mm ²	VCTF 0.75 - 1.50	VCTF 0.75 - 1.50	
Refrigerant	Type	-	R410A	R410A	
	Control Method	-	EEV INCLUDED	EEV INCLUDED	
Sound	Pressure	High / Low	dB(A)	54 / 47	58 / 54
	Power	Cooling		-	-
Dimension	Net Weight		kg	48.00	115.00
	Shipping Weight		kg	55.00	130.00
	Net Dimensions (WxHxD)		mm	650 x 1,850 x 400	1,100 x 1,800 x 485
	Shipping Dimensions (WxHxD)		mm	705 x 1,963 x 493	1,177 x 1,950 x 563
Panel Size	Panel model		-	-	-
	Panel Net Weight		kg	-	-
	Shipping Weight		kg	-	-
	Net Dimensions (WxHxD)		mm	-	-
	Shipping Dimensions (WxHxD)		mm	-	-
Additional Accessories	Drain Pump	Drain Pump	- / Model	-	-
		Max. lifting Height / Displacement	mm/liter/h	-	-
	Air Filter		-	-	-

NOTE

- 1) Mode : HP(Heat Pump), HR(Heat Recovery)
 - 2) Nominal Cooling : Indoor temperature 27°CDB / 19°CWB, Outdoor temperature 35°CDB/24°CWB, Refrigerant pipe length 7.5m, Level difference 0m.
 - 3) Nominal Heating : Indoor temperature 20°CDB / 15°CWB, Outdoor temperature 7°CDB / 6°CWB, Refrigerant pipe length 7.5m, Level difference 0m.
 - 4) Sound level was acquired in an anechoic room. Thus actual noise level may be different depending on the installation conditions.
 - 5) These products contain R410A which is fluorinated greenhouse gas.
 - 6) Specifications may be subject to change without prior notice.
 - 7) In case of AM280JNPDKH/TK, it operates with only 50Hz power supply.
- * Heat Exchanger type : Fin & Tube (Fin : Al, Tube : Cu)

2 Capacity Table

PAC

Cooling

TC : Total Capacity(kW), SHC : Sensible Heat Capacity(kW)

Capacity Index	Outdoor Air Temp. (°C,DB)	Indoor temperature													
		20(°C,DB)		23(°C,DB)		26(°C,DB)		27(°C,DB)		28(°C,DB)		30(°C,DB)		32(°C,DB)	
		14(°C,WB)		16(°C,WB)		18(°C,WB)		19(°C,WB)		20(°C,WB)		22(°C,WB)		24(°C,WB)	
		TC	SHC	TC	SHC	TC	SHC	TC	SHC	TC	SHC	TC	SHC	TC	SHC
140	10	9.7	8.6	11.4	9.7	13.1	10.5	14.0	10.8	14.6	10.9	15.7	11.0	16.8	10.9
	12	9.7	8.6	11.4	9.7	13.1	10.5	14.0	10.8	14.5	10.8	15.6	10.9	16.7	10.8
	14	9.7	8.6	11.4	9.7	13.1	10.5	14.0	10.8	14.5	10.8	15.6	10.9	16.7	10.8
	16	9.7	8.6	11.4	9.7	13.1	10.5	14.0	10.8	14.5	10.8	15.6	10.9	16.6	10.7
	18	9.7	8.6	11.4	9.7	13.1	10.5	14.0	10.8	14.5	10.8	15.5	10.8	16.6	10.7
	20	9.7	8.6	11.4	9.7	13.1	10.5	14.0	10.8	14.5	10.8	15.5	10.8	16.5	10.6
	21	9.7	8.6	11.4	9.7	13.1	10.5	14.0	10.8	14.5	10.8	15.5	10.8	16.5	10.6
	23	9.7	8.6	11.4	9.7	13.1	10.5	14.0	10.8	14.5	10.8	15.5	10.8	16.5	10.6
	25	9.7	8.6	11.4	9.7	13.1	10.5	14.0	10.8	14.5	10.8	15.5	10.8	16.5	10.6
	27	9.7	8.6	11.4	9.7	13.1	10.5	14.0	10.8	14.5	10.8	15.5	10.8	16.5	10.6
	29	9.7	8.6	11.4	9.7	13.1	10.5	14.0	10.8	14.5	10.8	15.5	10.8	16.5	10.6
	31	9.7	8.6	11.4	9.7	13.1	10.5	14.0	10.8	14.5	10.8	15.5	10.8	16.5	10.6
	33	9.7	8.6	11.4	9.7	13.1	10.5	14.0	10.8	14.5	10.8	15.5	10.8	16.5	10.6
	35	9.7	8.6	11.4	9.7	13.1	10.5	14.0	10.8	14.5	10.8	15.5	10.8	16.5	10.6
	37	9.7	8.6	11.4	9.7	13.1	10.5	14.0	10.8	14.5	10.8	15.4	10.7	16.3	10.5
	39	9.7	8.6	11.4	9.7	13.1	10.5	14.0	10.8	14.4	10.7	15.1	10.5	15.9	10.3
	42	9.7	8.6	11.4	9.7	13.0	10.4	13.8	10.7	14.2	10.6	14.8	10.3	15.5	10.0
	44	9.7	8.6	11.4	9.7	12.7	10.1	13.4	10.3	13.8	10.3	14.2	9.9	15.0	9.7
46	9.7	8.6	11.3	9.6	12.4	10.0	12.9	10.0	13.4	10.0	13.8	9.6	14.6	9.4	
48	9.6	8.5	11.1	9.5	12.2	9.8	12.6	9.7	13.1	9.8	13.4	9.3	14.1	9.1	
280	10	19.7	17.6	23.3	19.6	26.5	21.2	28.0	21.8	29.9	22.6	32.7	23.0	34.7	23.2
	12	19.7	17.6	23.3	19.6	26.5	21.2	28.0	21.8	29.9	22.8	32.7	23.1	34.7	23.4
	14	19.7	17.6	23.3	19.6	26.5	21.2	28.0	21.8	29.9	22.8	32.7	23.1	34.7	23.0
	16	19.7	17.6	23.3	19.6	26.5	21.2	28.0	21.8	29.9	22.8	32.7	23.1	34.7	23.3
	18	19.7	17.6	23.3	19.6	26.5	21.2	28.0	21.8	29.9	22.8	32.7	23.0	34.7	23.1
	20	19.7	17.6	23.3	19.6	26.5	21.2	28.0	21.8	29.9	22.8	32.7	23.0	34.3	23.0
	21	19.7	17.6	23.3	19.6	26.5	21.2	28.0	21.8	29.9	22.8	32.7	23.0	34.3	22.9
	23	19.7	17.6	23.3	19.6	26.5	21.2	28.0	21.8	29.9	22.8	32.7	23.2	33.7	22.6
	25	19.7	17.6	23.3	19.6	26.5	21.2	28.0	21.8	29.9	22.8	32.7	23.0	33.7	22.8
	27	19.7	17.6	23.3	19.6	26.5	21.2	28.0	21.8	29.9	22.8	32.7	23.0	33.7	22.8
	29	19.7	17.6	23.3	19.6	26.5	21.2	28.0	21.8	29.9	22.8	32.7	23.0	33.7	22.8
	31	19.7	17.6	23.3	19.6	26.5	21.2	28.0	21.8	29.9	22.8	32.7	23.2	33.7	22.8
	33	19.7	17.6	23.3	19.6	26.5	21.2	28.0	21.8	29.9	22.8	32.7	23.5	33.7	22.8
	35	19.7	17.6	23.3	19.6	26.5	21.2	28.0	21.8	29.9	22.6	32.7	23.5	33.7	23.0
	37	19.4	17.3	23.0	19.3	26.3	20.9	28.0	21.8	29.7	22.7	32.2	23.1	33.2	22.5
	39	19.2	17.1	22.7	19.1	26.3	20.9	27.9	21.6	29.5	22.5	31.8	23.4	32.8	22.4
	42	19.2	17.1	22.7	19.1	26.1	20.7	27.5	21.3	29.2	22.2	31.2	23.0	32.0	21.8
	44	19.2	17.1	22.7	19.1	25.4	20.2	26.6	20.6	28.3	21.6	30.0	22.1	30.9	21.1
46	19.2	17.1	22.5	18.9	25.0	19.9	25.8	20.0	27.5	21.0	29.0	21.4	30.0	20.5	
48	19.0	16.9	22.2	18.7	24.6	19.5	25.1	19.4	26.9	20.5	28.2	20.8	29.0	19.8	

2 Capacity Table

PAC

Heating

TC : Total Capacity(kW)

Capacity Index	Outdoor Air Temp. (°C)		Indoor temperature (°C,DB)				
			16(°C,DB)	18(°C,DB)	20(°C,DB)	22(°C,DB)	24(°C,DB)
	DB	WB	TC kW	TC kW	TC kW	TC kW	TC kW
140	-19.8	-20.0	9.5	9.5	9.4	9.4	9.3
	-18.8	-19.0	9.7	9.7	9.5	9.5	9.3
	-16.7	-17.0	10.2	10.0	9.7	9.6	9.4
	-14.7	-15.0	10.8	10.5	10.2	9.9	9.6
	-12.6	-13.0	11.1	10.9	10.7	10.4	10.1
	-10.5	-11.0	11.6	11.5	11.3	11.1	10.9
	-9.5	-10.0	11.8	11.7	11.5	11.4	11.2
	-8.5	-9.1	12.1	11.9	11.8	11.6	11.3
	-7.0	-7.6	12.4	12.2	12.1	11.8	11.5
	-5.0	-5.6	13.1	12.9	12.7	12.3	12.0
	-3.0	-3.7	13.8	13.6	13.4	12.9	12.4
	0.0	-0.7	14.4	14.2	14.0	13.4	12.8
	3.0	2.2	15.1	14.9	14.7	14.1	13.5
	5.0	4.1	15.8	15.6	15.3	14.4	13.5
	7.0	6.0	16.5	16.2	16.0	14.8	13.5
9.0	7.9	17.0	16.5	16.0	14.8	13.5	
11.0	9.8	17.5	16.7	16.0	14.8	13.5	
13.0	11.8	18.0	17.0	16.0	14.8	13.5	
15.0	13.7	18.5	17.2	16.0	14.8	13.5	
280	-19.8	-20.0	25.4	24.4	23.0	22.0	21.1
	-18.8	-19.0	25.6	24.6	23.2	22.3	21.6
	-16.7	-17.0	26.2	25.1	23.7	23.0	22.6
	-14.7	-15.0	27.2	26.1	24.7	23.9	23.5
	-12.6	-13.0	28.4	27.3	25.8	24.9	24.5
	-10.5	-11.0	30.4	29.2	27.5	26.4	26.0
	-9.5	-10.0	31.1	29.8	28.1	27.0	26.6
	-8.5	-9.1	31.4	30.1	28.4	27.4	26.9
	-7.0	-7.6	31.8	30.5	28.8	27.9	27.3
	-5.0	-5.6	32.7	31.5	29.7	29.0	28.1
	-3.0	-3.7	33.5	32.2	30.4	29.8	28.7
	0.0	-0.7	34.3	33.1	31.1	30.4	29.3
	3.0	2.2	35.0	33.7	31.5	30.4	29.5
	5.0	4.1	35.3	33.7	31.5	30.4	29.5
	7.0	6.0	35.7	33.7	31.5	30.4	29.5
9.0	7.9	35.7	33.7	31.5	30.4	29.5	
11.0	9.8	35.7	33.7	31.5	30.4	29.5	
13.0	11.8	35.7	33.7	31.5	30.4	29.5	
15.0	13.7	35.7	33.7	31.5	30.4	29.5	

3 Dimensional Drawing

PAC

AM140JNPDKH/TK

[Unit : mm]

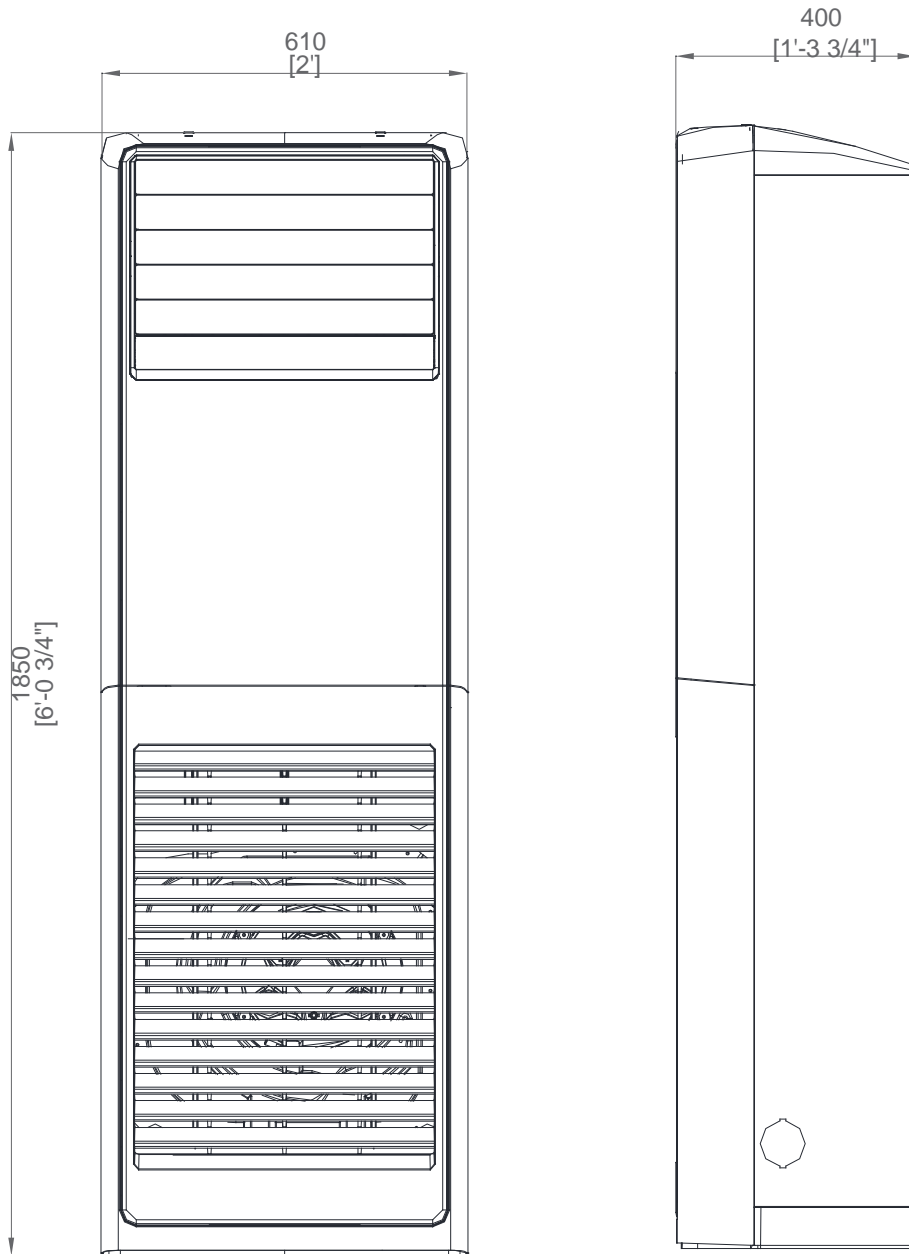

No.	Name	Description
1	Refrigerant gas pipe	Ø15.88 Flare
2	Refrigerant liquid pipe	Ø9.52 Flare
3	Drain pipe connection	-

3 Dimensional Drawing

PAC

AM280JNPDKH/TK

[Unit : mm]

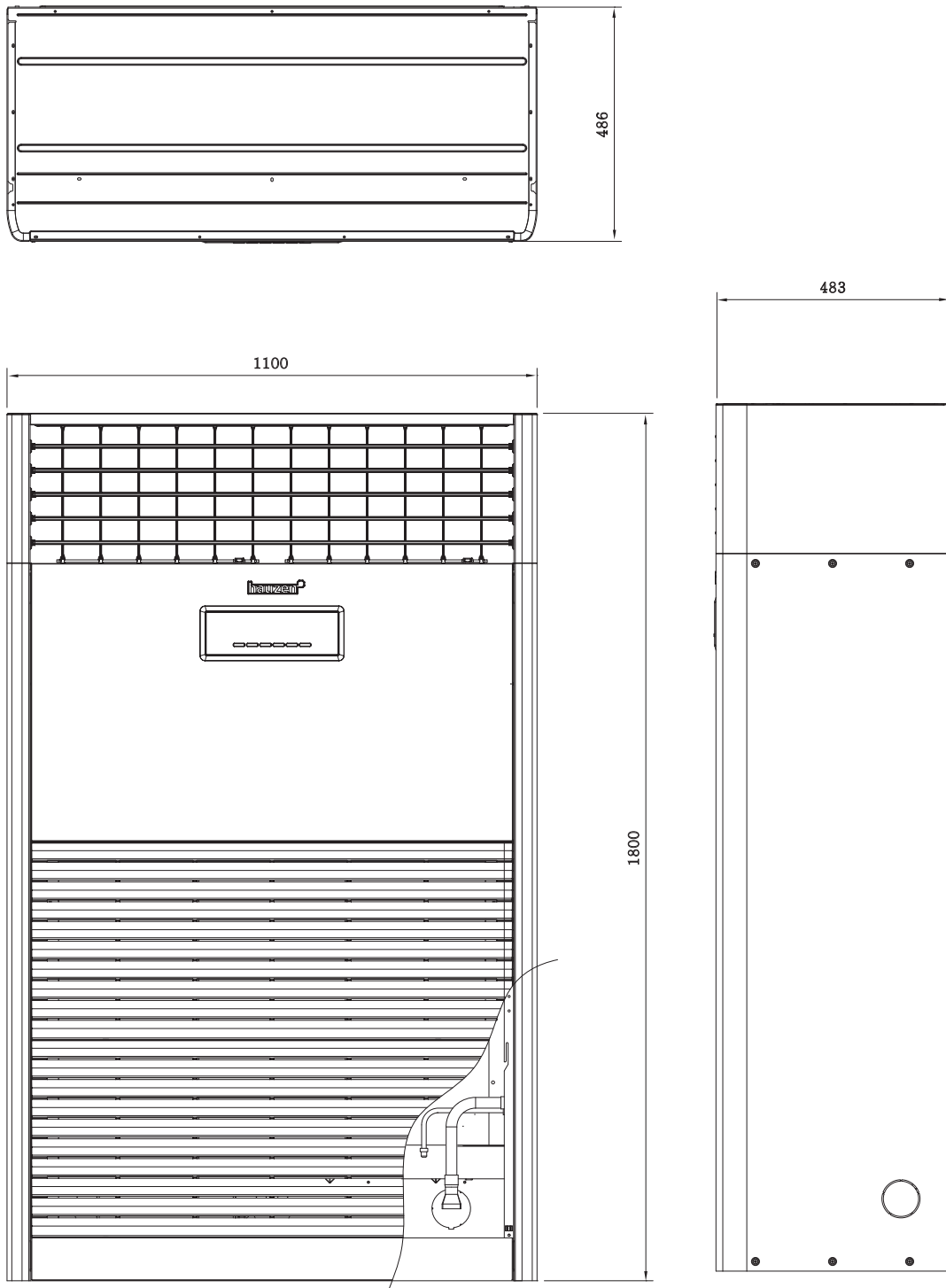

Name	Description
Refrigerant gas pipe	Φ22.22 Flare
Refrigerant liquid pipe	Φ9.52 Flare
Drain pipe connection	VP25 (OD 32, ID 25)

4 Electrical Wiring Diagram

PAC

AM140JNPDKH/TK

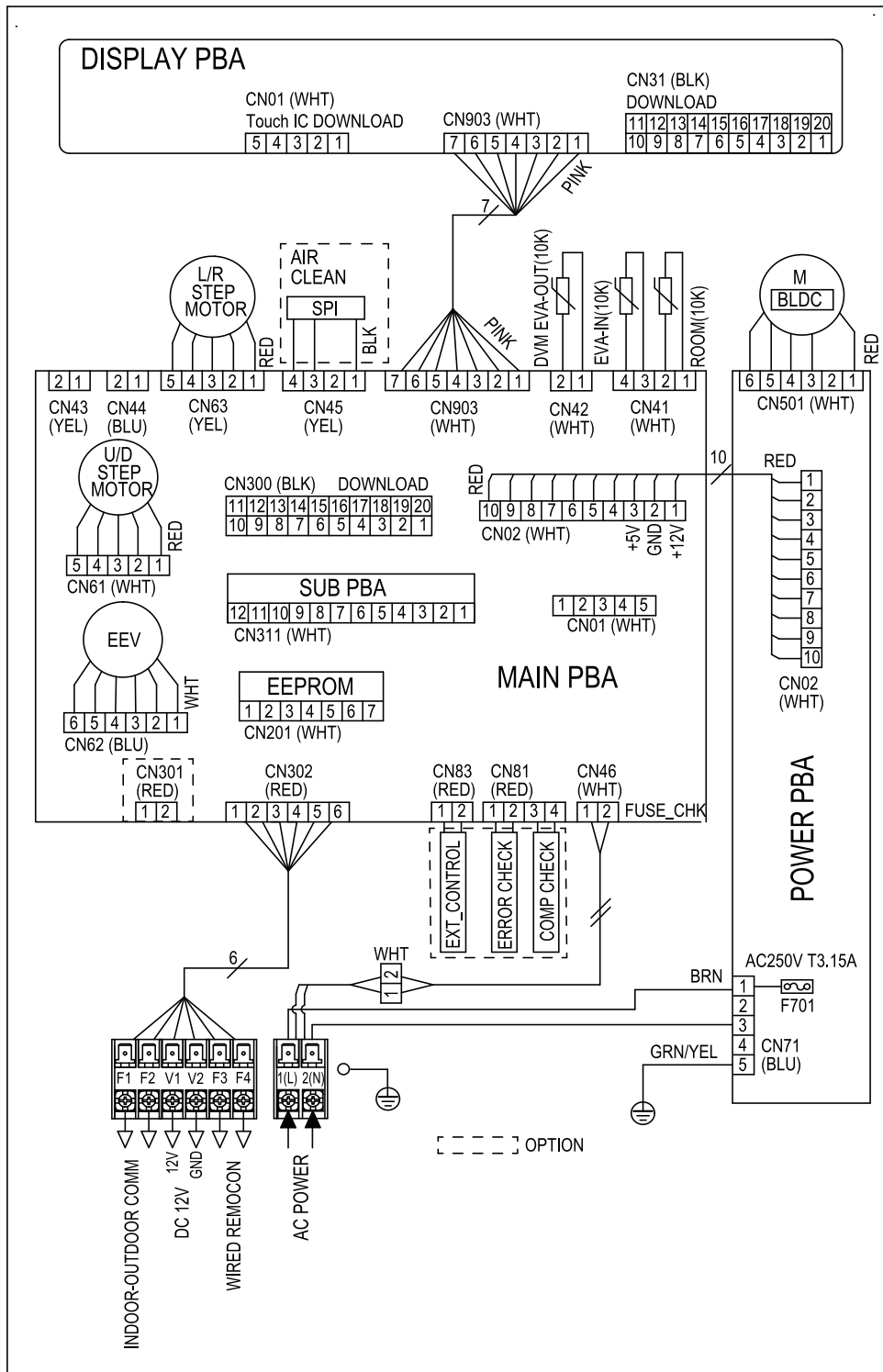

NOTE

1. This wiring diagram applies only to the indoor unit.
2. Symbols show as follow;
BLK : black, RED : red, BLU : blue, WHT:white, YEL : yellow, BRN : brown, SKY : sky-blue, GRN : green
3. For connection wiring indoor-outdoor transmission F1-F2, indoor-wired remotecontroller transmission F3-F4.
4. : Protective earth(screw), : Connector, n : The wire quantity

4 Electrical Wiring Diagram

PAC

AM280JNPDKH/TK

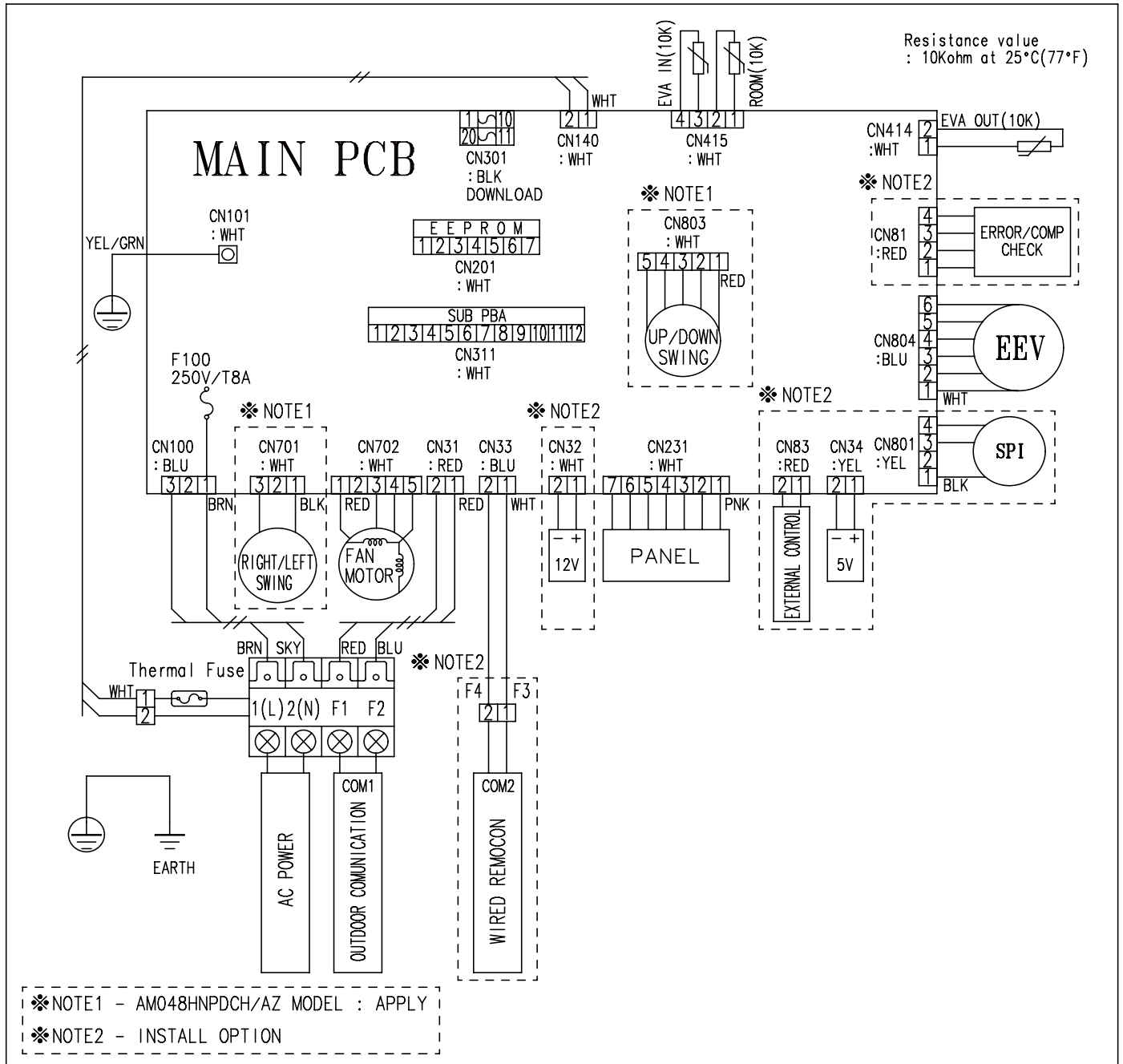

NOTE

1. This wiring diagram applies only to the indoor unit.
2. Symbols show as follow;
BLK : black, RED : red, BLU : blue, WHT:white, YEL : yellow, BRN : brown, SKY : sky-blue, GRN : green
3. For connection wiring indoor-outdoor transmission F1-F2, indoor-wired remotecontroller transmission F3-F4.
4. : Protective earth(screw), : Connector, n : The wire quantity

5 Sound Pressure Level

PAC

Unit: dB(A)

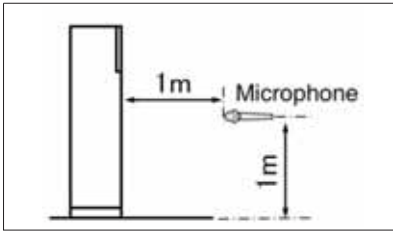

Model	High	Low
AM140JNPDKH/TK	54	47
AM280JNPDKH/TK	58	54

Note

Specifications may be subject to change without prior notice.
 Sound pressure level is obtained in an anechoic room.
 Sound pressure level is a relative value, depending on the distance and acoustic environment.
 Sound pressure level may differ depending on operation condition.
 dBA = A-weighted sound pressure level
 Reference acoustic pressure 0 dB= 20 uPa

NR Curve

1) AM140JNPDKH/TK

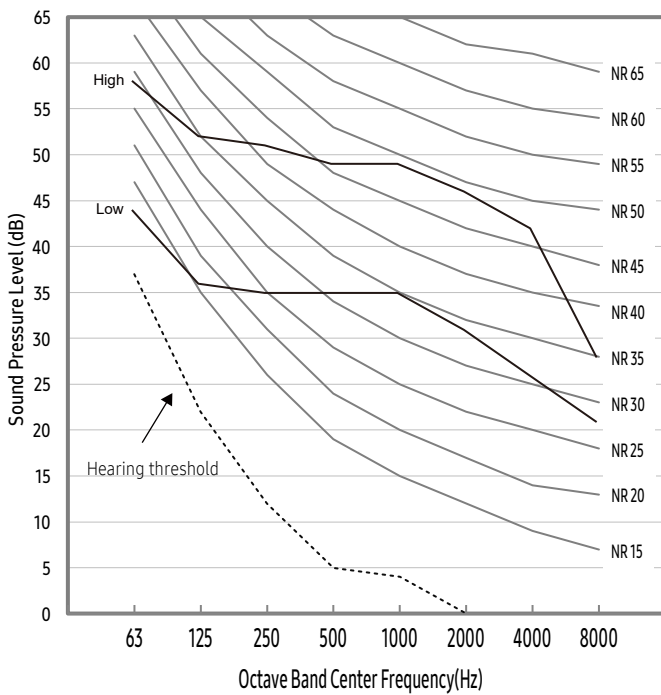

2) AM280JNPDKH/TK

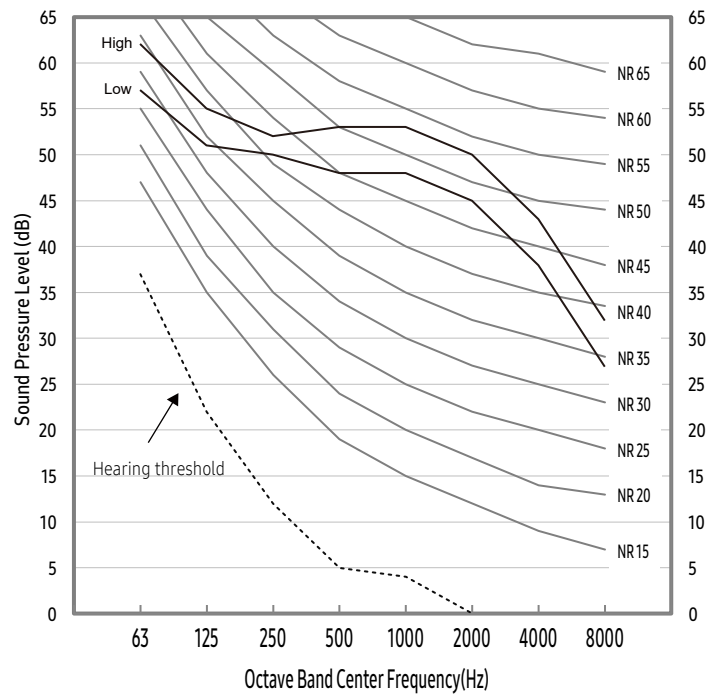

ERV Plus

- 1 *Specifications*
- 2 *Capacity Table*
- 3 *Dimensional Drawing*
- 4 *Electrical Wiring Diagram*
- 5 *Sound Pressure Level*
- 6 *Fan Characteristics*

1 Specifications

ERV Plus

1) Technical specifications

*Refer to following capacities when using the product with outdoor unit: AM050FNKDEH : 3.6kW , AM100FNKDEH : 7.1 kW

Model				AM050FNKDEH***	AM100FNKDEH***		
Power Supply				Ø, #, V, Hz	1, 2, 220~240, 50		
Performance	Temp. Exchange Efficiency	Cooling	Turbo	-	70		
			high	-	70		
			low	-	74		
		Heating	Turbo	-	75		
			high	-	75		
			low	-	79		
	Effective Enthalpy Exchange Efficiency	Cooling	Turbo	-	60		
			high	-	60		
			low	-	66		
		Heating	Turbo	-	73		
			high	-	73		
			low	-	79		
Outside Air Processing Capacity		Cooling *1) (DX Coil/Element)	-	5.1(3.6/1.5)	10.5(7.1/3.4)		
		Heating *2) (DX Coil/Element)	-	6.5(4.0/2.5)	13.2(8.0/5.2)		
Fan	Airflow rate		Turbo/High/Low(UL)	CMH	500/500/360	1000/1000/690	
				l/s	138.9/138.9/100	277.8/277.8/191.7	
	External Static pressure		Turbo/High/Low	mmAq	16.3/10.2/8.7	15.3/9.2/7.6	
				Pa	160/100/85	150/90/75	
	Motor		Type	-	BLDC	BLDC	
			Output	W	70	297	
Number of unit			EA	2	2		
Power	Power Input		Turbo	W	220	510	
					high	140	350
					low	90	235
	Current Input		Turbo	A	1.70	3.70	
					high	1.00	2.40
					low	0.60	1.60
Option Code				-	015617152380	0156171C2373	
Piping Connections	Liquid Pipe		Ø, mm	Ø, mm	6.35	6.35	
				Ø, inch	1/4	1/4	
	Gas Pipe		Ø, mm	Ø, mm	12.7	12.7	
				Ø, inch	1/2	1/2	
	Drain Pipe		Ø, mm	Ø, mm	VP25 (OD32, ID25)	VP25 (OD32, ID25)	
				Ø, inch	VP25 (OD 1-1/4", ID 1")	VP25 (OD 1-1/4", ID 1")	
Water Supply		Ø, mm	Ø, mm	12.7	12.7		
			Ø, inch	1/2	1/2		
Field Wiring	Power Source Wire		mm ²	1.5/2.5	1.5/2.5		
	Transmission Cable		mm ²	0.75~1.5	0.75~1.5		
Refrigerant	Type		-	R410A	R410A		
	Control Method		-	EEV	EEV		
Sound Pressure	Sound Level*4)	Turbo / High / Low	dB(A)	36 / 32 / 28	36 / 33 / 31		
Dimensions	Net Weight		kg	61.0	90.0		
	Shipping Weight		kg	75.2	107.5		
	Net Dimensions (WxHxD)		mm	1,553 x 270 x 1,000	1,763 x 340 x 1,135		
	Shipping Dimensions (WxHxD)		mm	1,847 x 349 x 1,300	2,027 x 428 x 1,424		
	Supply/Return/Exhaust/Outside Duct Flange (Ø)		mm	200	250		
Accessory	Air Filter		-	High Efficiency Filter(PP)	High Efficiency Filter(PP)		
Optional Accessory	S-Plasma ion kit		-	MSD-EAN1	MSD-EAN1		
	CO ₂ sensor		-	MOS-C1	MOS-C1		
	Humidity Sensor		-	Option	Option		
Ambient Condition	Around Unit		-	0~40°C DB, 80%RH or less	0~40°C DB, 80%RH or less		
	OA *5)		-	-15~40°C DB, 80%RH or less	-15~40°C DB, 80%RH or less		
	RA *5)		-	0~40°C DB, 80%RH or less	0~40°C DB, 80%RH or less		

* Specifications may be subject to change without prior notice for product improvement.

*1) Nominal cooling capacities are based on;

- Indoor temperature : 27°C DB, 19°C WB - Outdoor temperature : 35°C DB, 24°C WB, Equivalent refrigerant piping : 7.5m, Level differences : 0m

*2) Nominal heating capacities are based on;

- Indoor temperature : 20°C DB, 15°C WB

- Outdoor temperature : 7°C DB, 6°C WB, Equivalent refrigerant piping : 7.5m, Level differences : 0m

*3) Sound pressure was acquired in an anechoic room. Thus actual noise level may be different depending on the installation conditions.

*4) OA: fresh air from outdoor. RA: return air from room.

*5) These products contain R410A which is fluorinated greenhouse gas.

* Heat Exchanger type : Fin & Tube (Fin : Al, Tube : Cu)

2 Capacity table

ERV Plus

1) Cooling

TC : Total Capacity(kW), SHC : Sensible Heat Capacity(kW)

Capacity Index	Outdoor Air Temp.	Indoor temperature													
		14.0		16.0		18.0		19.0		20.0		22.0		24.0	
		TC kW	SHC kW	TC kW	SHC kW	TC kW	SHC kW	TC kW	SHC kW	TC kW	SHC kW	TC kW	SHC kW	TC kW	SHC kW
050	10	2.5	2.2	2.9	2.5	3.4	2.7	3.6	2.8	3.7	2.8	4.0	2.8	4.3	2.7
	12	2.5	2.2	2.9	2.5	3.4	2.7	3.6	2.8	3.7	2.8	4.0	2.8	4.3	2.7
	14	2.5	2.2	2.9	2.5	3.4	2.7	3.6	2.8	3.7	2.8	4.0	2.8	4.3	2.7
	16	2.5	2.2	2.9	2.5	3.4	2.7	3.6	2.8	3.7	2.8	4.0	2.8	4.3	2.7
	18	2.5	2.2	2.9	2.5	3.4	2.7	3.6	2.8	3.7	2.8	4.0	2.8	4.3	2.7
	20	2.5	2.2	2.9	2.5	3.4	2.7	3.6	2.8	3.7	2.8	4.0	2.8	4.2	2.6
	21	2.5	2.2	2.9	2.5	3.4	2.7	3.6	2.8	3.7	2.8	4.0	2.8	4.2	2.6
	23	2.5	2.2	2.9	2.5	3.4	2.7	3.6	2.8	3.7	2.8	4.0	2.8	4.2	2.6
	25	2.5	2.2	2.9	2.5	3.4	2.7	3.6	2.8	3.7	2.8	4.0	2.8	4.2	2.6
	27	2.5	2.2	2.9	2.5	3.4	2.7	3.6	2.8	3.7	2.8	4.0	2.8	4.2	2.6
	29	2.5	2.2	2.9	2.5	3.4	2.7	3.6	2.8	3.7	2.8	4.0	2.8	4.2	2.6
	31	2.5	2.2	2.9	2.5	3.4	2.7	3.6	2.8	3.7	2.8	4.0	2.8	4.2	2.6
	33	2.5	2.2	2.9	2.5	3.4	2.7	3.6	2.8	3.7	2.8	4.0	2.8	4.2	2.6
	35	2.5	2.2	2.9	2.5	3.4	2.7	3.6	2.8	3.7	2.8	3.9	2.7	4.2	2.6
	37	2.5	2.2	2.9	2.5	3.4	2.7	3.6	2.8	3.7	2.8	3.9	2.7	4.1	2.5
	39	2.5	2.2	2.9	2.5	3.4	2.7	3.6	2.8	3.7	2.8	3.8	2.7	4.0	2.4
	42	2.5	2.2	2.9	2.5	3.4	2.7	3.5	2.7	3.6	2.7	3.8	2.6	3.9	2.4
	44	2.5	2.2	2.9	2.5	3.3	2.6	3.4	2.6	3.5	2.7	3.6	2.5	3.8	2.3
46	2.5	2.2	2.9	2.5	3.2	2.5	3.3	2.6	3.4	2.6	3.5	2.4	3.7	2.2	
48	2.5	2.2	2.8	2.4	3.2	2.5	3.2	2.5	3.3	2.5	3.4	2.4	3.5	2.2	
100	10	4.9	4.3	5.8	5.0	6.7	5.2	7.1	5.4	7.4	5.6	8.0	5.7	8.5	5.4
	12	4.9	4.3	5.8	5.0	6.7	5.2	7.1	5.4	7.4	5.6	7.9	5.6	8.5	5.4
	14	4.9	4.3	5.8	5.0	6.7	5.2	7.1	5.4	7.4	5.6	7.9	5.6	8.5	5.4
	16	4.9	4.3	5.8	5.0	6.7	5.2	7.1	5.4	7.4	5.6	7.9	5.6	8.4	5.3
	18	4.9	4.3	5.8	5.0	6.7	5.2	7.1	5.4	7.4	5.6	7.9	5.6	8.4	5.3
	20	4.9	4.3	5.8	5.0	6.7	5.2	7.1	5.4	7.4	5.6	7.9	5.6	8.4	5.3
	21	4.9	4.3	5.8	5.0	6.7	5.2	7.1	5.4	7.4	5.6	7.9	5.6	8.4	5.3
	23	4.9	4.3	5.8	5.0	6.7	5.2	7.1	5.4	7.4	5.6	7.9	5.6	8.4	5.3
	25	4.9	4.3	5.8	5.0	6.7	5.2	7.1	5.4	7.4	5.6	7.9	5.6	8.4	5.3
	27	4.9	4.3	5.8	5.0	6.7	5.2	7.1	5.4	7.4	5.6	7.9	5.6	8.4	5.3
	29	4.9	4.3	5.8	5.0	6.7	5.2	7.1	5.4	7.4	5.6	7.9	5.6	8.4	5.3
	31	4.9	4.3	5.8	5.0	6.7	5.2	7.1	5.4	7.4	5.6	7.9	5.6	8.4	5.3
	33	4.9	4.3	5.8	5.0	6.7	5.2	7.1	5.4	7.4	5.6	7.9	5.6	8.4	5.3
	35	4.9	4.3	5.8	5.0	6.7	5.2	7.1	5.4	7.3	5.5	7.8	5.5	8.2	5.2
	37	4.9	4.3	5.8	5.0	6.7	5.2	7.1	5.4	7.3	5.5	7.7	5.4	8.1	5.1
	39	4.9	4.3	5.8	5.0	6.7	5.2	7.0	5.3	7.2	5.4	7.6	5.3	7.9	5.0
	42	4.9	4.3	5.8	5.0	6.6	5.1	6.9	5.3	7.1	5.4	7.4	5.2	7.7	4.8
	44	4.9	4.3	5.8	5.0	6.4	5.0	6.7	5.1	6.9	5.2	7.1	5.0	7.4	4.7
46	4.9	4.3	5.7	5.0	6.3	4.9	6.5	4.9	6.7	5.1	6.9	4.8	7.2	4.6	
48	4.8	4.2	5.7	4.9	6.2	4.8	6.3	4.8	6.6	5.0	6.7	4.7	7.0	4.4	

2) Heating

TC : Total Capacity(kW)

Capacity Index	Outdoor Air Temp. (°C)		Indoor temperature				
			16.0	18.0	20.0	22.0	24.0
	DB	WB	TC kW	TC kW	TC kW	TC kW	TC kW
050	-9.5	-10.0	2.9	2.9	2.9	2.8	2.8
	-8.5	-9.1	3.0	3.0	3.0	2.9	2.9
	-7.0	-7.6	3.1	3.1	3.0	3.0	2.9
	-5.0	-5.6	3.3	3.2	3.2	3.1	3.0
	-3.0	-3.7	3.4	3.4	3.3	3.2	3.1
	0.0	-0.7	3.6	3.6	3.5	3.4	3.2
	3.0	2.2	3.8	3.7	3.7	3.5	3.4
	5.0	4.1	3.9	3.9	3.8	3.6	3.4
	7.0	6.0	4.1	4.1	4.0	3.7	3.4
	9.0	7.9	4.2	4.1	4.0	3.7	3.4
	11.0	9.8	4.4	4.2	4.0	3.7	3.4
	13.0	11.8	4.5	4.2	4.0	3.7	3.4
	15.0	13.7	4.6	4.3	4.0	3.7	3.4
	-9.5	-10.0	6.0	5.9	5.8	5.7	5.6
	-8.5	-9.1	6.1	6.0	5.9	5.8	5.7
-7.0	-7.6	6.2	6.1	6.0	5.9	5.8	
-5.0	-5.6	6.5	6.5	6.4	6.2	6.0	
-3.0	-3.7	6.9	6.8	6.7	6.4	6.2	
0.0	-0.7	7.2	7.1	7.0	6.7	6.4	
3.0	2.2	7.6	7.5	7.3	7.1	6.8	
5.0	4.1	7.9	7.8	7.7	7.2	6.8	
7.0	6.0	8.2	8.1	8.0	7.4	6.8	
9.0	7.9	8.5	8.2	8.0	7.4	6.8	
11.0	9.8	8.7	8.4	8.0	7.4	6.8	
13.0	11.8	9.0	8.5	8.0	7.4	6.8	
15.0	13.7	9.2	8.6	8.0	7.4	6.8	

3 Dimensional drawing

ERV Plus

Unit:mm

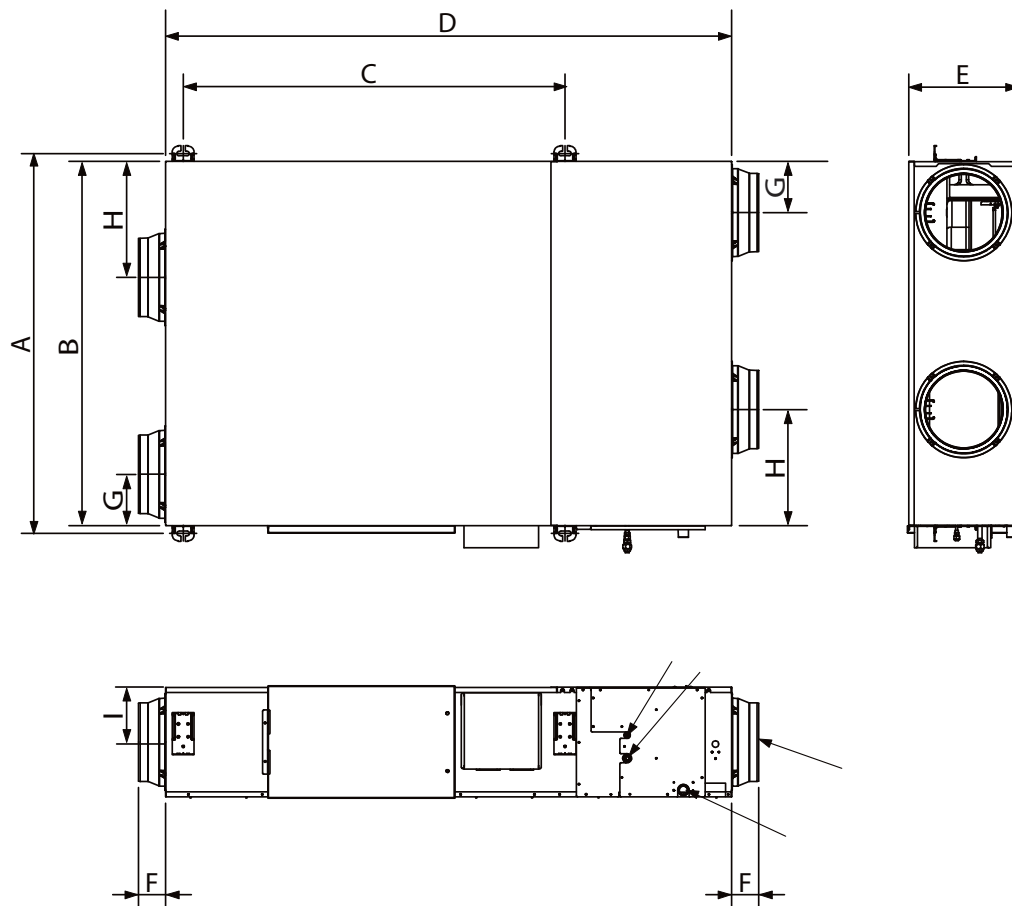

Model	A	B	C	D	E	F	G	H	I
AM050FNKDEH	1036	1000	987	1553	270	99	130	253	135
AM100FNKDEH	1183	1135	1189	1763	340	84	160	362	170

No.	Name	Description	
		500CMH	1000CMH
①	Liquid pipe connection	Ø6.35 (1/4")	
②	Gas pipe connection	Ø12.70 (1/2")	
③	Drain pipe connection	VP25 (OD32, ID25)	
④	Nominal diameter for duct	AM050FNKDEH	Ø200
		AM100FNKDEH	Ø250

4 Electrical Wiring Diagram

ERV Plus

AM050/100FNKDEH/EU

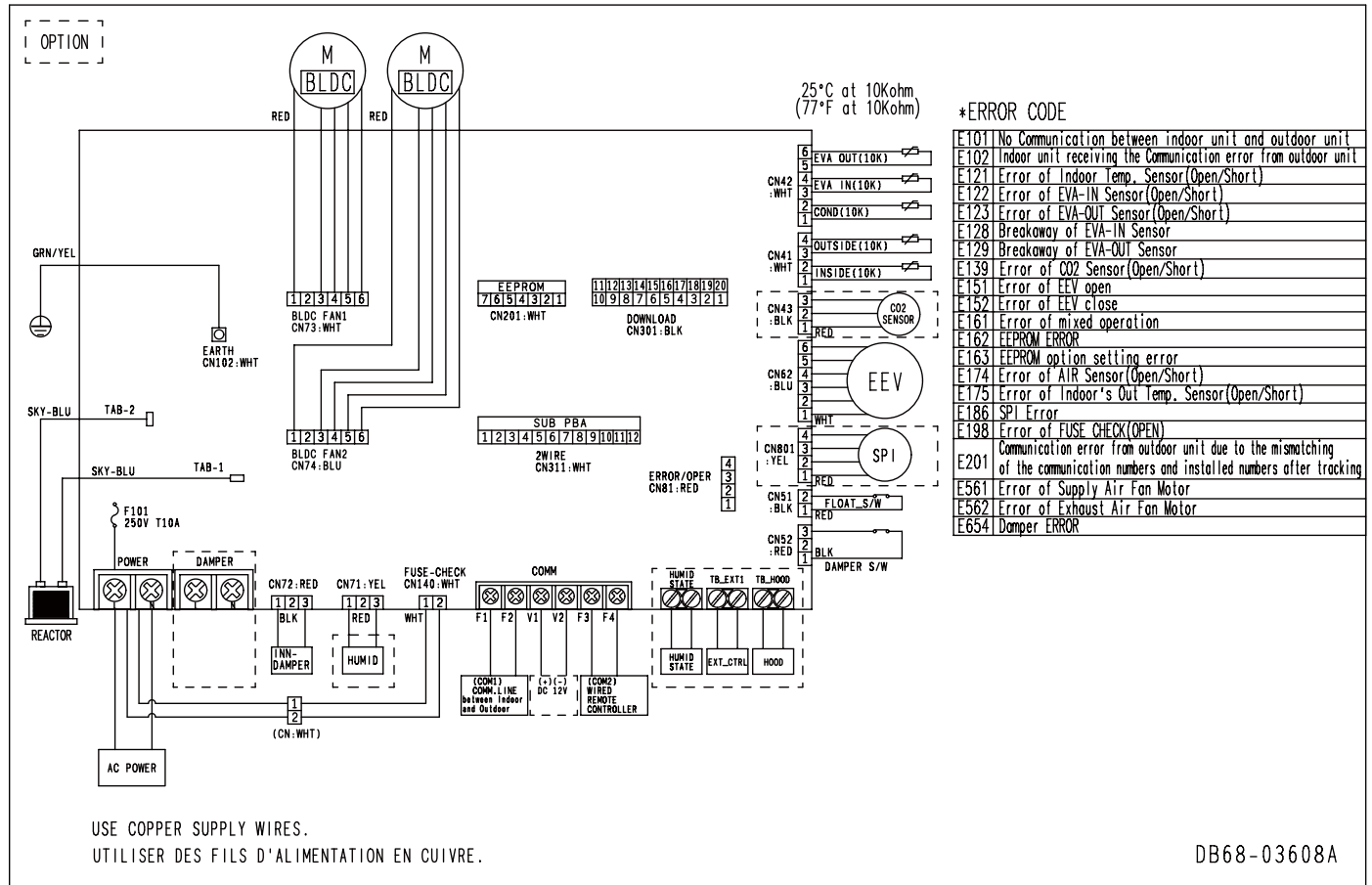

NOTE

1. This wiring diagram applies only to the indoor unit.
2. Symbols show as follow;
BLK : black, RED : red, BLU : blue, WHT:white, YEL : yellow, BRN : brown, SKY : sky-blue, GRN : green
3. For connection wiring indoor-outdoor transmission F1-F2, indoor-wired remotecontroller transmission F3-F4.
4. : Protective earth(screw), : Connector, _n : The wire quantity

5 Sound pressure level

ERV Plus

1) Operation sound level

Unit : dB(A)

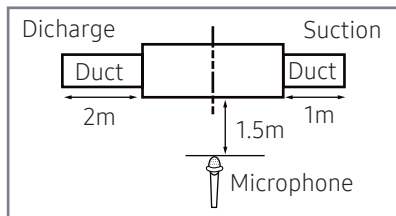

Model	Turbo	High	Low
AM050FNKDEH***	36	32	28
AM100FNKDEH ***	36	33	31

✓ Note

Specifications may be subject to change without prior notice.
 Sound pressure level is obtained in an anechoic room.
 Sound pressure level is a relative value, depending on the distance and acoustic environment.
 Sound pressure level may differ depending on operation condition.
 dBA = A-weighted sound pressure level
 Reference acoustic pressure 0 dB= 20 uPa

2) NR curve

(1) AM050FNKDEH * * *

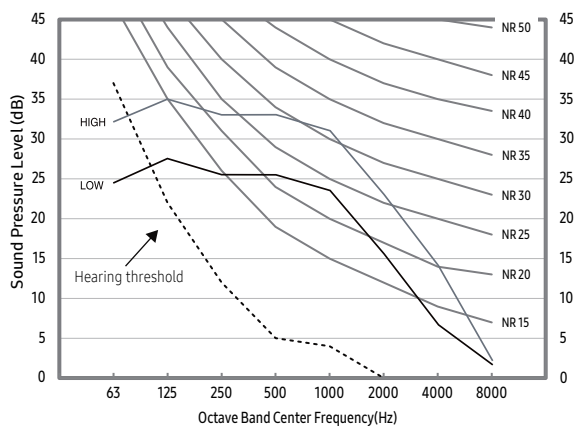

(2) AM100FNKDEH * * *

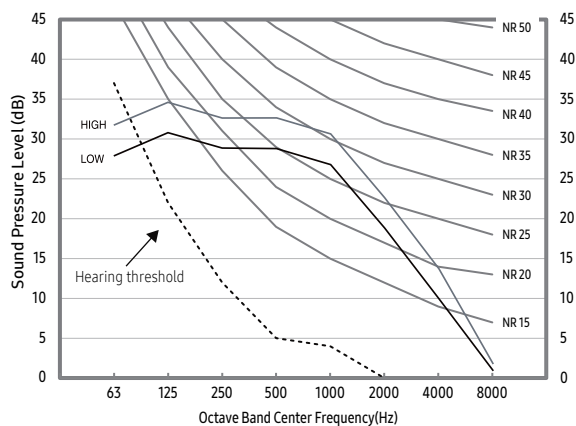

6 Fan Characteristics

ERV Plus

1) AM050FNKDEH/EU

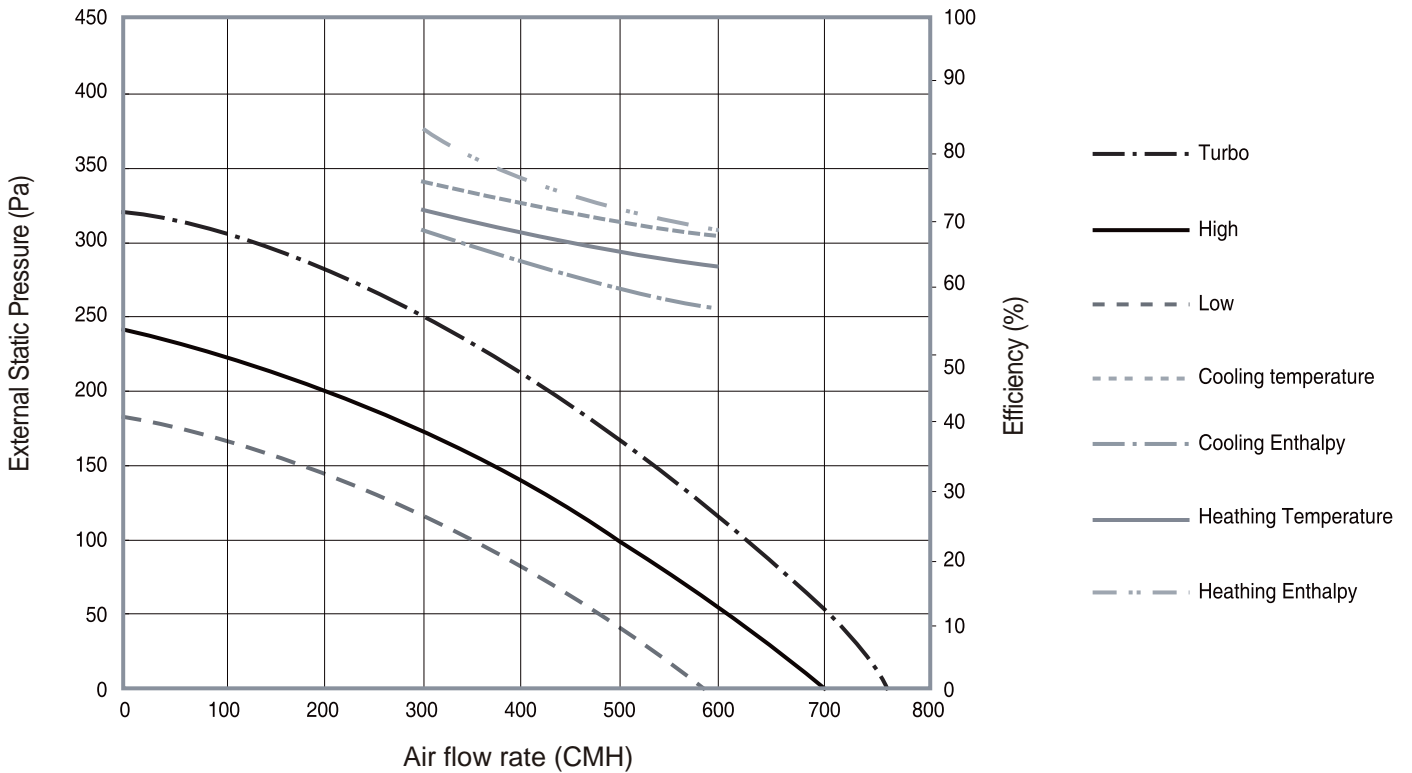

2) AM100FNKDEH/EU

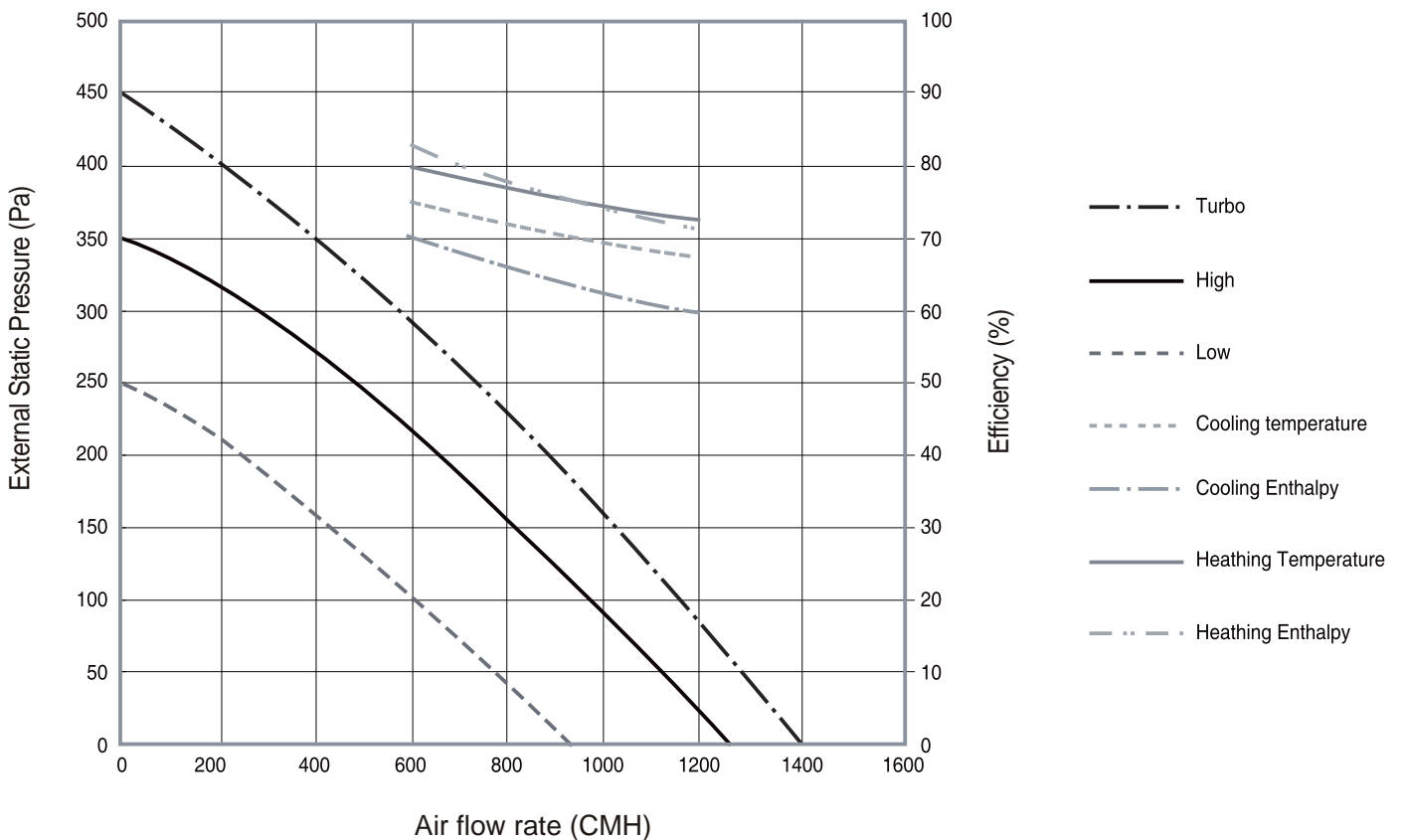

Hydro Unit HE

- 1 *Specifications*
- 2 *Capacity Table*
- 3 *Capacity & Power Input Correction*
- 4 *Operation Range*
- 5 *Piping Diagram*
- 6 *Dimensional Drawing*
- 7 *Electrical Wiring Diagram*
- 8 *Sound Pressure Level*
- 9 *Hydraulic Performance*

1 Specifications

Hydro Unit HE

1) Technical specifications

Model			AM160FNBDEH***	AM320FNBDEH***	AM500FNBDEH***	
Power Supply			Ø, #, V, Hz	1, 2, 220-240, 50	1, 2, 220-240, 50	
Mode			-	HP/HR	HP/HR	
Performance	Capacity (Nominal)	Cooling *1)	kW	14.0	28.0	
			Btu/h	47,800	95,600	
		Heating *2)	kW	16.0	31.5	
			Btu/h	54,600	107,500	
Power	Power Input (Nominal)	Cooling *1)	W	10.00	10.00	
		Heating *2)		10.00	10.00	
	Current Input (Nominal)	Cooling *1)	A	0.05	0.05	
		Heating *2)		0.05	0.05	
	MCA (Including External Contact)		A	2.2	2.2	
	MFA			2.75	2.75	
Compressor	Type		-	-	-	
	Output		kW x n	-	-	
	Model Name		-	-	-	
	Oil	Type	-	-	-	
Initial Charge		cc	-	-		
Heat Exchanger	Type		-	PHE	PHE	
	Quantity		-	1	1	
	Pipe Size		Ø, inch	PT 1 (25A)	PT 1 (25A)	
	Water Flow Rate		LPM	48	92	
	Flow Switch		LPM	20	30	
Option Code			-	01004C-105000-208C8C-332200	01004C-105000-231C1C-332200	
Piping Connections	Liquid Pipe		Ø, mm	9.52	9.52	
			Ø, inch	3/8"	3/8"	
	Gas Pipe			Ø, mm	15.88	22.2
				Ø, inch	5/8"	7/8"
Drain Pipe		Ø,mm	-	-		
FieldWiring	Power Source Wire (L<10m, Single Installation)		mm2	2.5	2.5	
	Transmission Cable		mm2	0.75 ~ 1.5	0.75 ~ 1.5	
Refrigerant	Type		-	-	-	
	Control Method		-	EEV	EEV	
Sound	Sound Pressure *3)		dB(A)	27	28	
	Sound Power			-	-	
Dimensions	Net Weight		kg	29.00	34.00	
	Shipping Weight		kg	31.00	36.00	
	Net Dimensions (W×H×D)		mm	518 x 627 x 330	518 x 627 x 330	
	Shipping Dimensions (W×H×D)		mm	652 x 700 x 426	652 x 700 x 426	
Operating Temp. Range	Ambient	Cooling	°C	-5.0 ~ 48.0	-5.0 ~ 48.0	
		Heating	°C	-20 ~ 35	-20 ~ 35	
		Hot Water (Main Cooling, HR)	°C	-20.0 ~ 35(43)	-20.0 ~ 35(43)	
	Leaving Water	Cooling	°C	5.0 ~ 30.0	5.0 ~ 30.0	
		Heating	°C	20.0 ~ 50.0	20.0 ~ 50.0	

* Specifications may be subject to change without prior notice for product improvement.

*1) Nominal cooling capacities are based on;
 - Water temperature : 23°C inlet, 18°C outlet
 - Indoor temperature : 27°C DB, 19°C WB
 - Outdoor temperature : 35°C DB, 24°C WB

*2) Nominal heating capacities are based on;
 - Water temperature : 30°C inlet, 35°C outlet
 - Indoor temperature : 20°C DB
 - Outdoor temperature : 7°C DB, 6°C WB

*3) Sound pressure was acquired in an anechoic room. Thus actual noise level may be different depending on the installation conditions.

*4) These products contain R410A which is fluorinated greenhouse gas.

* Heat Exchanger type : Plate Heat Exchanger (STS)

2 Capacity table

Hydro Unit HE

1) Cooling

Capacity (kW)	Outdoor temp.(°C)		Water inlet temp.(°C)				
	DB	10	15	20	23	25	30
14	-5	11.2	12.6	14.5	15.3	15.8	16.6
	-3	11.2	12.6	14.5	15.3	15.8	16.6
	-1	11.2	12.6	14.5	15.3	15.8	16.6
	0	11.2	12.6	14.5	15.3	15.8	16.6
	2	11.2	12.6	14.5	15.3	15.8	16.6
	4	11.2	12.6	14.5	15.3	15.8	16.6
	6	11.2	12.6	14.5	15.3	15.8	16.6
	8	11.2	12.6	14.5	15.3	15.8	16.6
	10	11.2	12.6	14.5	15.3	15.8	16.6
	12	11.2	12.6	14.5	15.3	15.8	16.6
	14	11.2	12.6	14.5	15.3	15.8	16.6
	16	11.2	12.6	14.5	15.3	15.8	16.6
	18	11.2	12.6	14.5	15.3	15.8	16.6
	20	11.2	12.6	14.5	15.3	15.8	16.6
	22	11.2	12.6	14.5	15.3	15.8	16.4
	24	11.2	12.6	14.3	15.1	15.6	16.2
	26	11.2	12.4	14.1	14.9	15.4	16.0
	28	10.8	12.2	14.0	14.7	15.1	15.8
	30	10.4	12.0	13.8	14.5	14.9	15.6
	32	10.1	11.8	13.6	14.3	14.7	15.5
34	9.7	11.6	13.4	14.1	14.5	15.3	
35	9.5	11.5	13.4	14.0	14.4	15.2	
36	9.3	11.4	13.3	13.9	14.3	15.1	
38	8.9	11.2	13.1	13.7	14.1	14.9	
40	8.6	11.0	13.0	13.5	13.8	14.7	
28	-5	22.4	28.0	30.9	32.8	34.0	35.3
	-3	22.4	28.0	30.9	32.8	34.0	35.3
	-1	22.4	28.0	30.9	32.8	34.0	35.3
	0	22.4	28.0	30.9	32.8	34.0	35.3
	2	22.4	28.0	30.9	32.8	34.0	35.3
	4	22.4	28.0	30.9	32.8	34.0	35.3
	6	22.4	28.0	30.9	32.8	34.0	35.3
	8	22.4	28.0	30.9	32.8	34.0	35.3
	10	22.4	28.0	30.9	32.8	34.0	35.3
	12	22.4	28.0	30.9	32.8	34.0	35.3
	14	22.4	28.0	30.9	32.8	34.0	35.3
	16	22.4	28.0	30.9	32.8	34.0	35.3
	18	22.4	28.0	30.9	32.8	34.0	35.3
	20	22.4	28.0	30.9	32.8	34.0	35.3
	22	22.4	28.0	30.9	32.8	34.0	35.3
	24	22.4	28.0	30.3	32.0	33.2	34.0
	26	22.4	27.2	29.7	31.3	32.4	33.3
	28	21.6	26.5	29.0	30.5	31.5	32.5
	30	20.9	25.7	28.4	29.8	30.7	31.8
	32	20.1	24.9	27.8	29.1	29.9	31.1
34	19.4	24.2	27.2	28.3	29.1	30.4	
35	19.0	23.8	26.9	28.0	28.7	30.1	
36	18.6	23.4	26.6	27.6	28.3	29.7	
38	17.9	22.7	26.0	26.8	27.4	28.9	
40	17.2	21.9	25.4	26.1	26.5	28.2	
44.8	-5	35.8	40.3	46.3	48.8	50.5	53.1
	-3	35.8	40.3	46.3	48.8	50.5	53.1
	-1	35.8	40.3	46.3	48.8	50.5	53.1
	0	35.8	40.3	46.3	48.8	50.5	53.1
	2	35.8	40.3	46.3	48.8	50.5	53.1
	4	35.8	40.3	46.3	48.8	50.5	53.1
	6	35.8	40.3	46.3	48.8	50.5	53.1
	8	35.8	40.3	46.3	48.8	50.5	53.1
	10	35.8	40.3	46.3	48.8	50.5	53.1
	12	35.8	40.3	46.3	48.8	50.5	53.1
	14	35.8	40.3	46.3	48.8	50.5	53.1
	16	35.8	40.3	46.3	48.8	50.5	53.1
	18	35.8	40.3	46.3	48.8	50.5	53.1
	20	35.8	40.3	46.3	48.8	50.5	53.1
	22	35.8	40.3	46.3	48.8	50.5	52.4
	24	35.8	40.3	45.8	48.2	49.8	51.8
	26	35.8	39.7	45.3	47.6	49.2	51.3
	28	34.6	39.0	44.7	47.0	48.5	50.7
	30	33.4	38.4	44.2	46.4	47.8	50.1
	32	32.2	37.7	43.7	45.7	47.1	49.5
34	31.0	37.1	43.1	45.1	46.4	48.9	
35	30.4	36.8	42.9	44.8	46.1	48.6	
36	29.8	36.4	42.6	44.5	45.7	48.3	
38	28.6	35.8	42.0	43.8	45.0	47.7	
40	27.4	35.1	41.4	43.1	44.3	47.1	

2 Capacity table

Hydro Unit HE

2) Heating

Capacity (kW)	Outdoor temp.(°C)		Water inlet temp.(°C)			
	DB	WB	20	30	40	45
16	-20.0	-20.2	12.4	11.7	7.2	4.7
	-17.5	-17.8	12.9	12.1	8.1	5.8
	-15.0	-15.3	13.4	12.5	8.9	6.8
	-12.5	-13.0	13.9	12.9	9.8	7.7
	-10.0	-10.5	14.3	13.3	10.6	8.6
	-7.5	-8.1	14.8	13.7	11.5	9.1
	-5.0	-5.6	15.3	14.1	12.3	9.6
	-2.5	-3.3	15.8	14.5	12.6	9.6
	0.0	-0.7	16.3	14.9	12.8	9.6
	2.5	1.7	16.8	15.3	12.8	9.6
	5.0	4.1	17.2	15.7	12.8	9.6
	7.0	6.0	17.6	16.0	12.8	9.6
	10.0	8.9	17.6	16.0	12.8	9.6
	12.5	11.3	17.6	16.0	12.8	9.6
	15.0	13.7	17.6	16.0	12.8	9.6
	20.0	15.0	17.6	16.0	12.8	9.6
25.0	18.3	17.6	16.0	12.8	9.6	
30.0	21.3	17.6	16.0	12.8	9.6	
35.0	24.0	17.6	16.0	12.8	9.6	
31.5	-20.0	-20.2	24.4	23.1	14.2	7.9
	-17.5	-17.8	26.0	24.5	16.3	10.0
	-15.0	-15.3	27.5	25.8	18.4	12.0
	-12.5	-13.0	29.0	27.2	20.6	14.1
	-10.0	-10.5	30.5	28.6	22.7	16.2
	-7.5	-8.1	32.1	30.0	24.9	17.6
	-5.0	-5.6	33.6	31.4	27.0	18.9
	-2.5	-3.3	33.7	31.5	27.7	18.9
	0.0	-0.7	33.8	31.5	28.4	18.9
	2.5	1.7	33.9	31.5	28.4	18.9
	5.0	4.1	33.9	31.5	28.4	18.9
	7.0	6.0	34.1	31.5	28.4	18.9
	10.0	8.9	34.1	31.5	28.4	18.9
	12.5	11.3	34.1	31.5	28.4	18.9
	15.0	13.7	34.1	31.5	28.4	18.9
	20.0	15.0	34.1	31.5	28.4	18.9
25.0	18.3	34.1	31.5	28.4	18.9	
30.0	21.3	34.1	31.5	28.4	18.9	
35.0	24.0	34.1	31.5	28.4	18.9	
50.4	-20.0	-20.2	39.1	36.9	22.7	15.2
	-17.5	-17.8	40.6	38.2	25.4	18.3
	-15.0	-15.3	42.1	39.4	28.1	21.3
	-12.5	-13.0	43.7	40.7	30.7	24.3
	-10.0	-10.5	45.2	42.0	33.3	27.2
	-7.5	-8.1	46.7	43.3	36.0	28.7
	-5.0	-5.6	48.2	44.5	38.6	30.2
	-2.5	-3.3	49.7	45.8	39.5	30.2
	0.0	-0.7	51.2	47.1	40.3	30.2
	2.5	1.7	52.7	48.4	40.3	30.2
	5.0	4.1	54.2	49.6	40.3	30.2
	7.0	6.0	55.4	50.4	40.3	30.2
	10.0	8.9	55.4	50.4	40.3	30.2
	12.5	11.3	55.4	50.4	40.3	30.2
	15.0	13.7	55.4	50.4	40.3	30.2
	20.0	15.0	55.4	50.4	40.3	30.2
25.0	18.3	55.4	50.4	40.3	30.2	
30.0	21.3	55.4	50.4	40.3	30.2	
35.0	24.0	55.4	50.4	40.3	30.2	

3 Capacity & Power input correction

Hydro Unit HE

1) By water flow rate

(1) AM160FNBDEH***

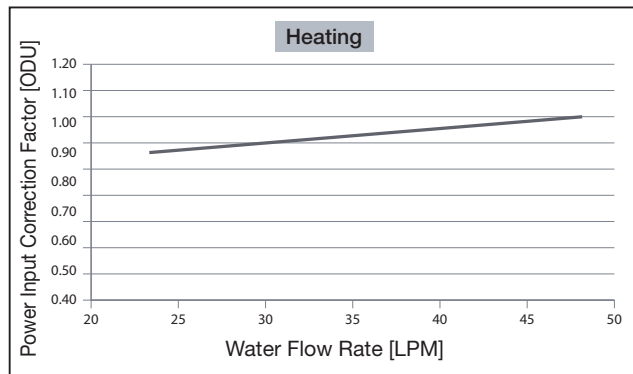
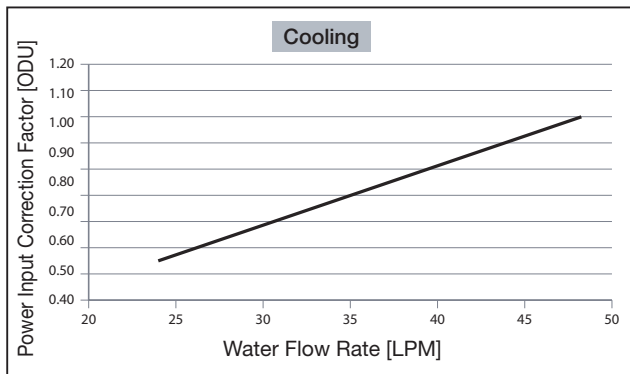
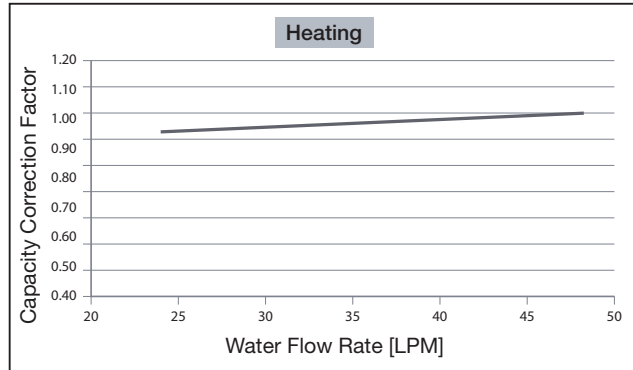
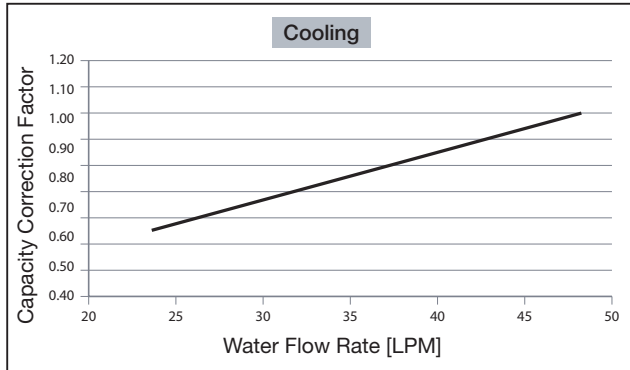

Cooling

Water flow Rate (LPM)	24.0	36.0	48.0
Capacity Correction Factor	0.66	0.83	1.00
Power Input Correction Factor [ODU]	0.55	0.78	1.00

Heating

Water flow Rate (LPM)	24.0	36.0	48.0
Capacity Correction Factor	0.92	0.96	1.00
Power Input Correction Factor [ODU]	0.87	0.94	1.00

◆ Flow rate by ΔT

Flow Rate [LPM]	5HP	10HP	16HP
$\Delta T=10^{\circ}\text{C}$	24.0	46.0	75.0
$\Delta T=5^{\circ}\text{C}$	48.0	92.0	150.0

* Minimum flow rate of the Hydro unit is 50% of rated flow rate.

3 Capacity & Power input correction

Hydro Unit HE

1) By water flow rate

(2) AM320FNBDEH***

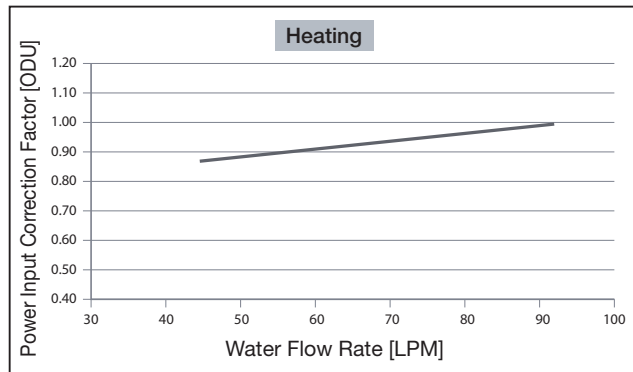
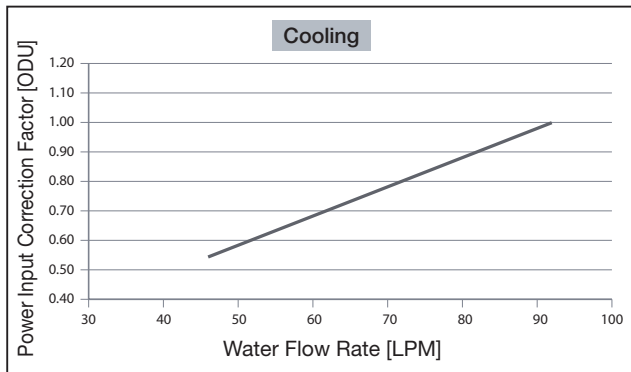
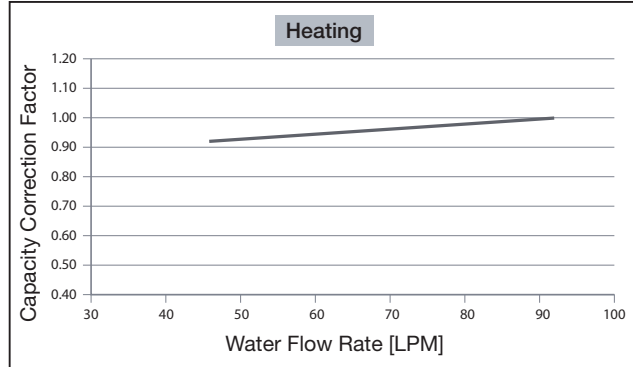
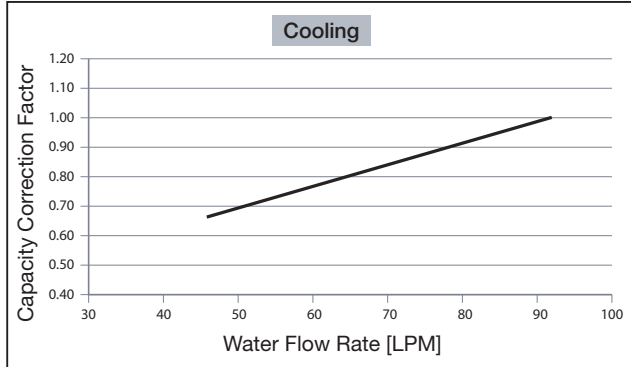

Cooling

Water flow Rate (LPM)	46.0	69.0	92.0
Capacity Correction Factor	0.66	0.83	1.00
Power Input Correction Factor [ODU]	0.55	0.78	1.00

Heating

Water flow Rate (LPM)	46.0	69.0	92.0
Capacity Correction Factor	0.92	0.96	1.00
Power Input Correction Factor [ODU]	0.87	0.94	1.00

◆ Flow rate by ΔT

Flow Rate [LPM]	5HP	10HP	16HP
$\Delta T=10^{\circ}\text{C}$	24.0	46.0	75.0
$\Delta T=5^{\circ}\text{C}$	48.0	92.0	150.0

* Minimum flow rate of the Hydro unit is 50% of rated flow rate.

3 Capacity & Power input correction

Hydro Unit HE

1) By water flow rate

(3) AM500FNBDEH***

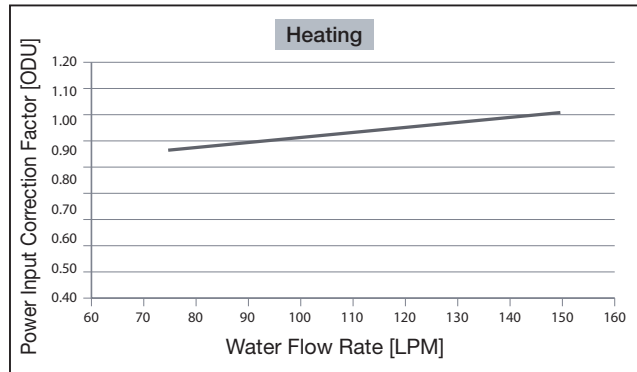
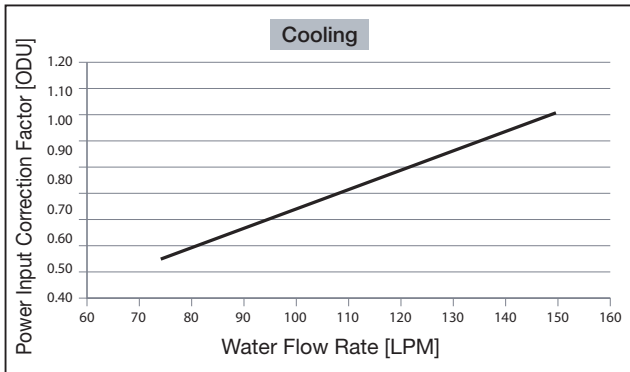
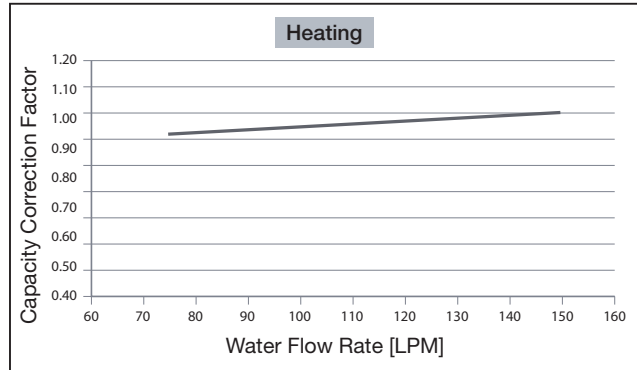
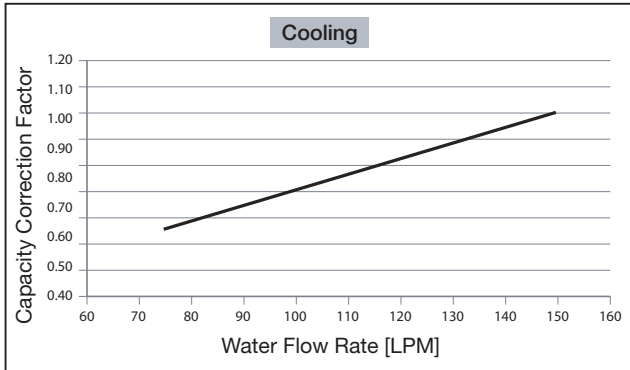

Cooling

Water flow Rate (LPM)	75.0	112.5	150.0
Capacity Correction Factor	0.66	0.83	1.00
Power Input Correction Factor [ODU]	0.55	0.78	1.00

Heating

Water flow Rate (LPM)	75.0	112.5	150.0
Capacity Correction Factor	0.92	0.96	1.00
Power Input Correction Factor [ODU]	0.87	0.94	1.00

◆ Flow rate by ΔT

Flow Rate [LPM]	5HP	10HP	16HP
$\Delta T=10^{\circ}\text{C}$	24.0	46.0	75.0
$\Delta T=5^{\circ}\text{C}$	48.0	92.0	150.0

* Minimum flow rate of the Hydro unit is 50% of rated flow rate.

3 Capacity & Power input correction

Hydro Unit HE

2) By outdoor air temperature

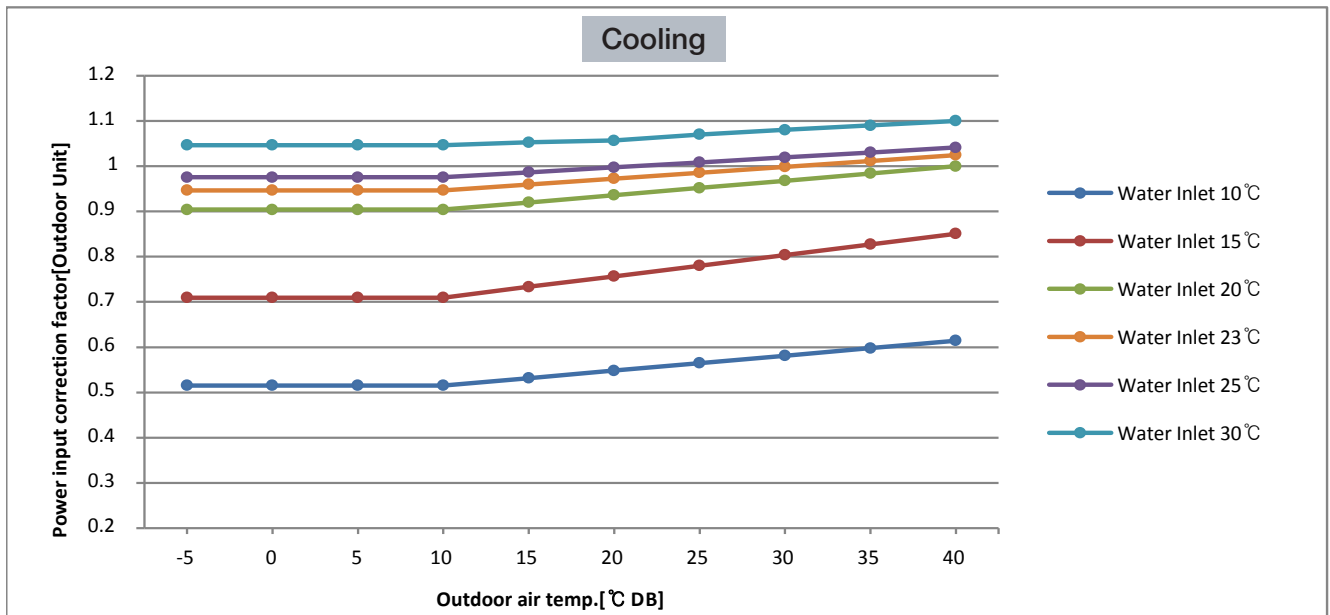

Power input correction factor (Cooling)

Outdoor air temp. (DB, °C)	Water inlet temp. (°C)					
	10	15	20	23	25	30
-5	0.52	0.71	0.90	0.95	0.98	1.05
0	0.52	0.71	0.90	0.95	0.98	1.05
5	0.52	0.71	0.90	0.95	0.98	1.05
10	0.52	0.71	0.90	0.95	0.98	1.05
15	0.53	0.73	0.92	0.96	0.99	1.05
20	0.55	0.76	0.94	0.97	1.00	1.06
25	0.56	0.78	0.95	0.99	1.01	1.07
30	0.58	0.80	0.97	1.00	1.02	1.08
35	0.60	0.83	0.98	1.01	1.03	1.09
40	0.61	0.85	1.00	1.02	1.04	1.10

3 Capacity & Power input correction

Hydro Unit HE

2) By outdoor air temperature

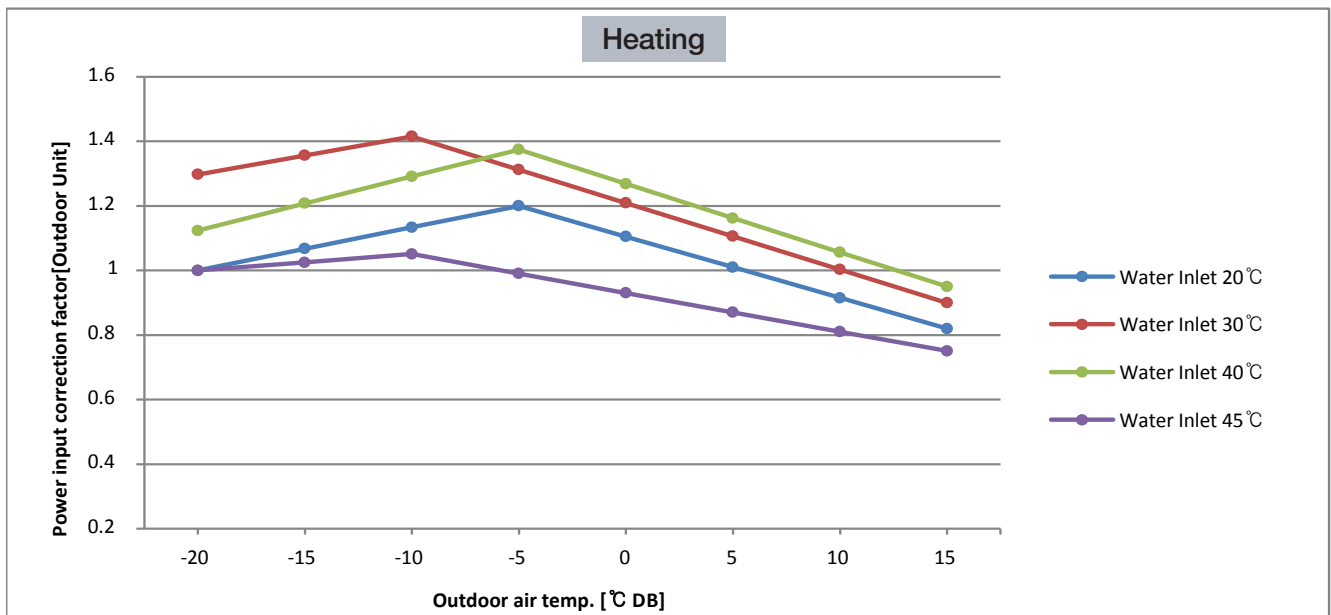

Power input correction factor (Heating)

Outdoor air temp. (°C)		Water inlet temp. (°C)			
DB	WB	20	30	40	45
-20	-20.2	1.00	1.30	1.12	1.00
-15	-15.3	1.07	1.36	1.21	1.03
-10	-10.5	1.13	1.42	1.29	1.05
-5	-5.6	1.20	1.31	1.37	0.99
0	-0.7	1.11	1.21	1.27	0.93
5	4.1	1.01	1.11	1.16	0.87
7	6	0.97	1.06	1.14	0.85
10	8.9	0.92	1.00	1.11	0.81
15	13.7	0.82	0.90	0.95	0.75
20	15	0.81	0.89	0.94	0.75
25	18.3	0.81	0.89	0.94	0.74
30	21.3	0.81	0.88	0.93	0.74
35	24	0.80	0.88	0.93	0.73

4 Operation range

Hydro Unit HE

1) Heating

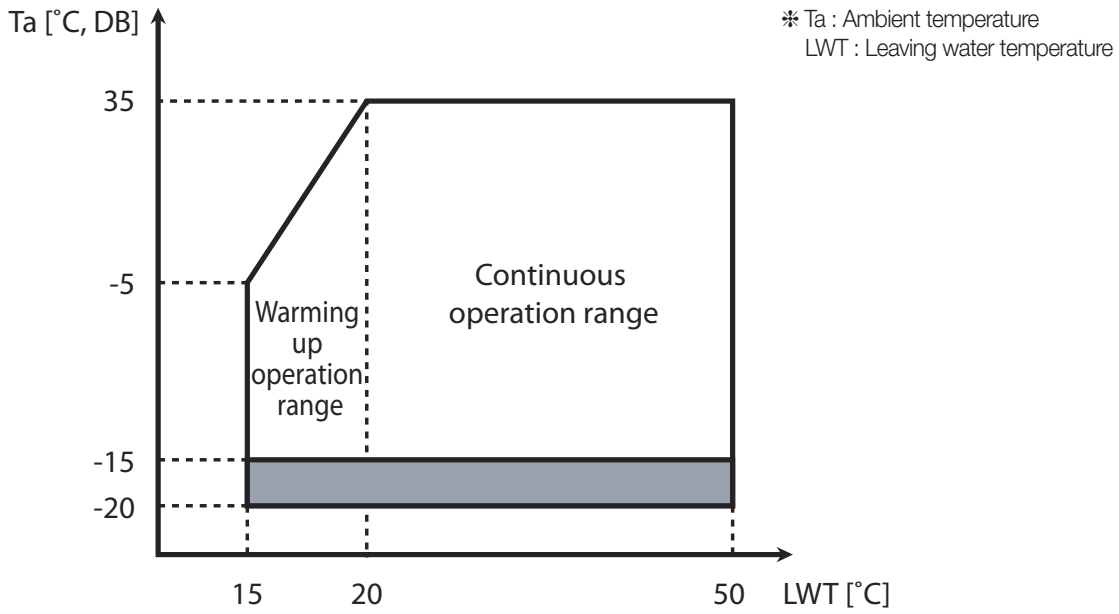

2) Cooling

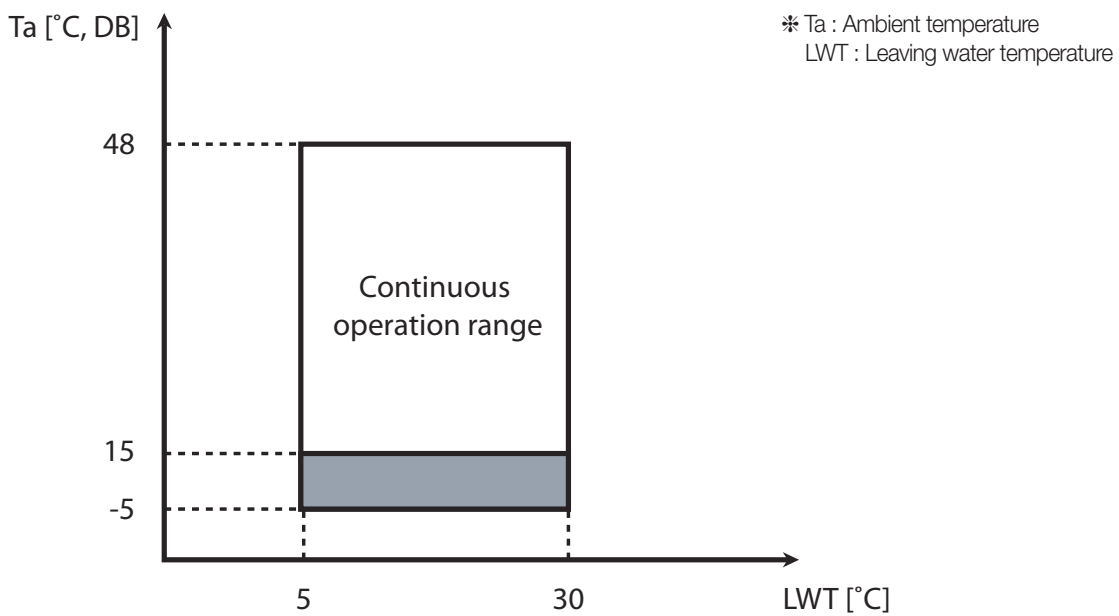

*  : Operation of outdoor unit possible, but no guarantee of capacity in this condition.

5 Piping diagram

Hydro Unit HE

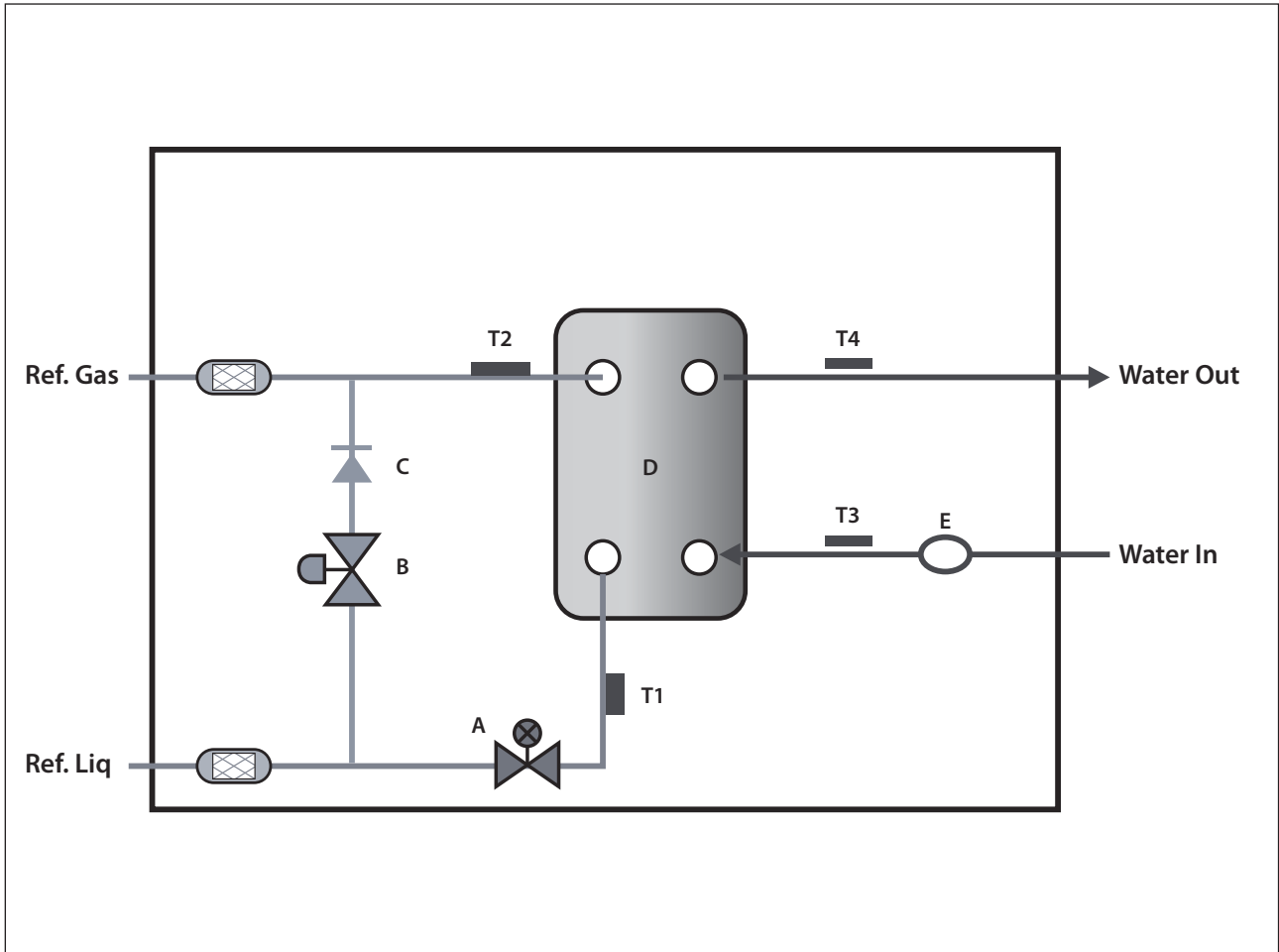

Symbol	Name
A	EEV
B	Bypass Valve for Defrost
C	Check Valve
D	Heat Exchanger
E	Flow Switch
T1	Eva. Inlet Temp. Sensor
T2	Eva. Outlet Temp. Sensor
T3	Water Inlet Temp. Sensor
T4	Water Outlet Temp. Sensor

6 Dimensional drawing

Hydro Unit HE

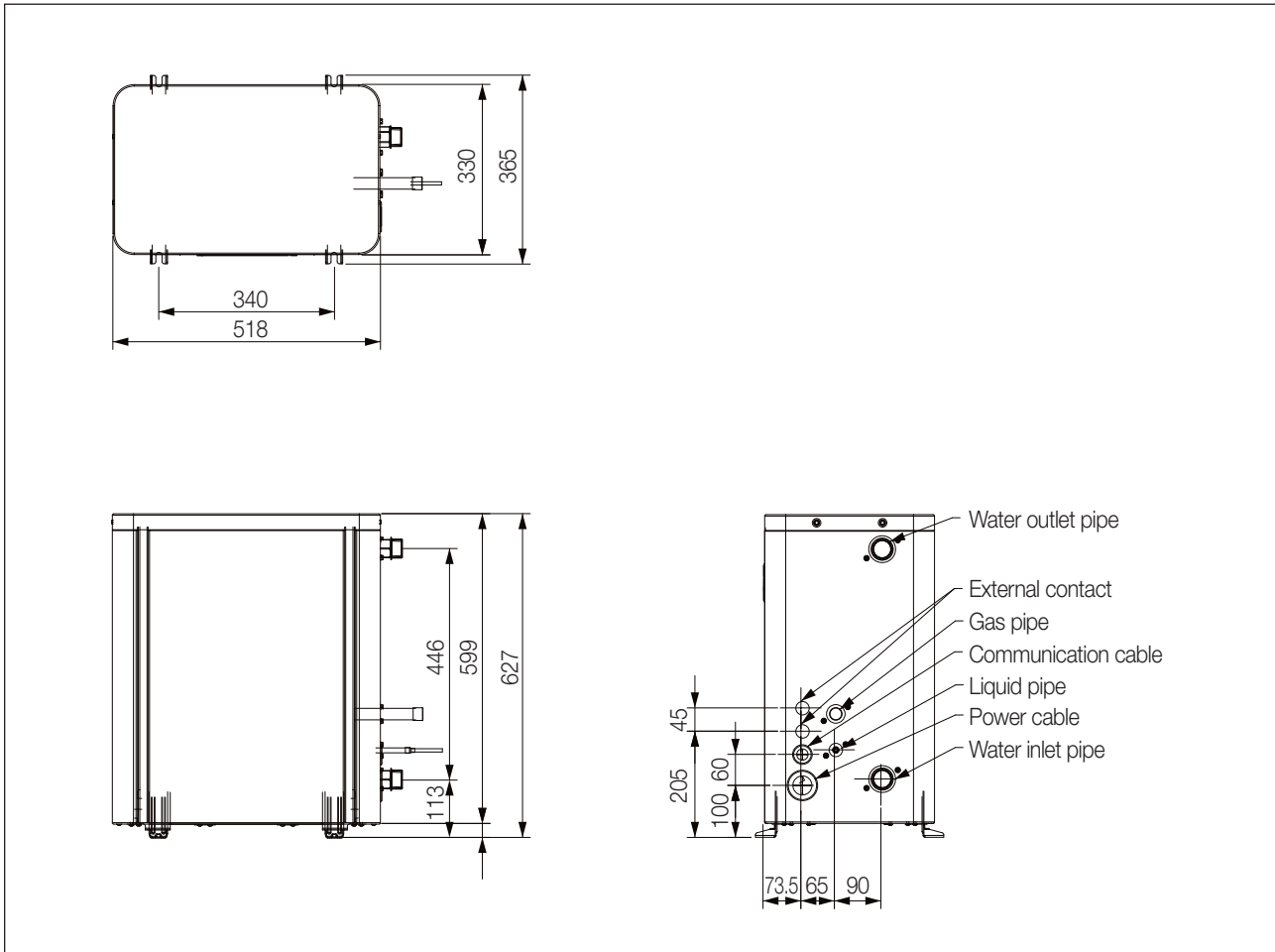

Model name of DVM Hydro unit		AM160FNBDEH***	AM320FNBDEH***	AM500FNBDEH***
Refrigerant side	Liquid pipe	3/8" (ø9.52)	3/8" (ø9.52)	1/2" (ø12.7)
	Gas pipe	5/8" (ø15.88)	7/8" (ø22.23)	1-1/8" (ø28.58)
Water side	Water inlet/outlet pipe	PT 1 (25 A)	PT 1 (25 A)	PT 1-1/4 (32 A)

7 Electrical Wiring Diagram

Hydro Unit HE

AM160/320/500FNBDEH/EU

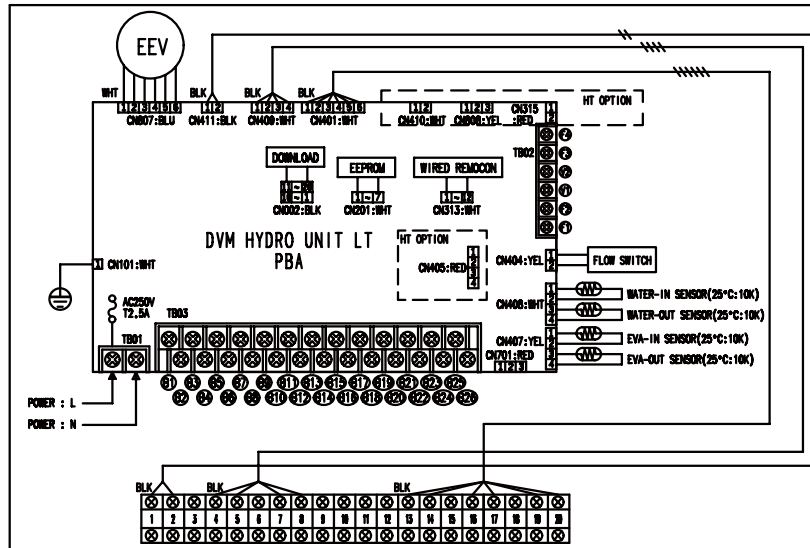

Display	Explanation
E101	Communication error between DVM Hydro unit and outdoor unit (When DVM Hydro unit is having trouble with receiving data from outdoor unit)
E102	Communication error on outdoor unit
E121	Error on room temperature sensor of DVM Hydro unit (Short or Open)
E122	Error on EVA IN sensor of DVM Hydro unit (Short or Open)
E123	Error on EVA OUT sensor of DVM Hydro unit (Short or Open)
E128	EVA IN sensor of DVM Hydro unit is detached
E129	EVA OUT sensor of DVM Hydro unit is detached
E130	EVA IN and EVA OUT sensor of DVM Hydro unit is detached
E151	Error due to opened EEV of DVM Hydro unit (2nd detection)
E152	Error due to closed EEV of DVM Hydro unit (2nd detection)
E161	Mixed operation mode error
E162	EEPROM error
E163	EEPROM option setting error
E177	Emergency error : water pipe check
E185	Cross wiring error (When power line is connected to communication line of DVM Hydro unit)
E198	Error due to disconnected Thermal Fuse (When the temperature of terminal block is increases)
E901	Error on the sensor of water inlet pipe (Short or Open)
E902	Error on the sensor of water outlet pipe (Short or Open)
E907	Error due to pipe rupture protection
E908 E909	Error due to freeze prevention
E910	Water temperature sensor on water outlet pipe is detached
E911 E913	Error due to turned off Flow switch off flow switch (when switch turns off within 10 seconds after pump starts to operate)
E914	Error due to incorrect thermostat connection

Terminal No.	External contact	Operation status/inspection checklist	Remarks
B1 - B2	OPERATION CHECK	Check on/off status for operation temp of the control panel on the site	Optional
B3 - B4	ALARM	Check on/off status for alarm temp of the panel on the site	Optional
B5 - B6	MAIN PUMP	Check the status of the pump operation signal and on/off status of operation at the control panel on the site	Mandatory
B7 - B8	HEATER	Check the status of the heater operation signal input at the control panel on the site	Optional
B9 - B10 - B11	3WAY 1 V/V	Check the status of signal output and on/off status of valve operation (Direction switch of the indoor hot water tank)	Optional
B12 - B13 - B14	3WAY 2 V/V	Check the status of signal output and on/off status of valve operation (Interlocked with water energy pump signal)	Optional
B15 - B16 - B17	2WAY V/V	Check the status of signal output or operation status of the valve	Optional
B19 - B20	AC230, THERMOSTAT 1	Check the connection status of the thermostat and operation status of the product (cooling)	Optional
B21 - B22	AC230, THERMOSTAT 2	Check the connection status of the thermostat and operation status of the product (heating)	Optional
B23 - B24	AC24, THERMOSTAT 1	Check the connection status of the thermostat and operation status of the product (cooling)	Optional
B25 - B26	AC24, THERMOSTAT 2	Check the connection status of the thermostat and operation status of the product (heating)	Optional
1 - 2	ROOM TEMP	Check the temperature display on the wired remote controller after separately installing the indoor temperature sensor (Refer to option setting of the wired remote controller)	Optional
7 - 8	WATER TANK TEMP	Check the temperature display on the wired remote controller after installing the 4-20mA temperature sensor	Mandatory (not order supply)
13 - 14	SOLAR PUMP	Check the solar pump contact signal input and status of the operation	Optional
16 - 17	EXT. CONTROL	Check the contact signal input and status of the operation	Optional
19 - 20	SMART GRID	Check the Smart Grid contact input and the signal	Optional

NOTE

1. This wiring diagram applies only to the indoor unit.
2. Symbols show as follow;
BLK : black, RED : red, BLU : blue, WHT:white, YEL : yellow, BRN : brown, SKY : sky-blue, GRN : green
3. For connection wiring indoor-outdoor transmission F1-F2, indoor-wired remotecontroller transmission F3-F4.
4. : Protective earth(screw), : Connector, n : The wire quantity

8 Sound pressure level

Hydro Unit HE

1) Operation sound level

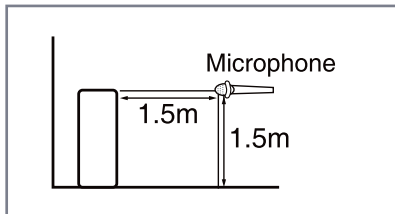

Unit : dB(A)

Model	Cooling	Heating
AM160FNBDEH ***	27	26
AM320FNBDEH ***	28	27
AM500FNBDEH ***	30	31

✓ Note

Specifications may be subject to change without prior notice.

Sound pressure level is obtained in an anechoic room.

Sound pressure level is a relative value, depending on the distance and acoustic environment.

Sound pressure level may differ depending on operation condition.

dBA = A-weighted sound pressure level

Reference acoustic pressure 0 dB= 20 uPa

2) NR curve

(1) AM160FNBDEH * * *

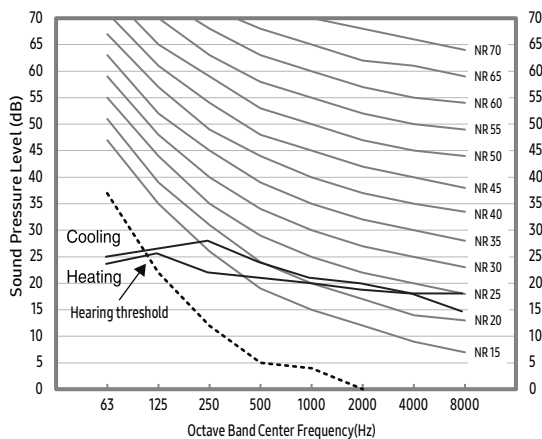

(2) AM320FNBDEH * * *

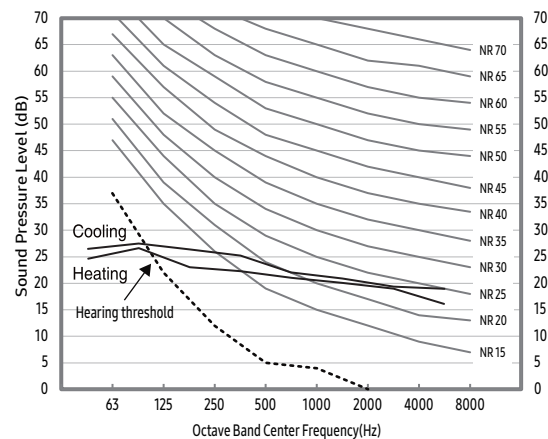

(3) AM500FNBDEH * * *

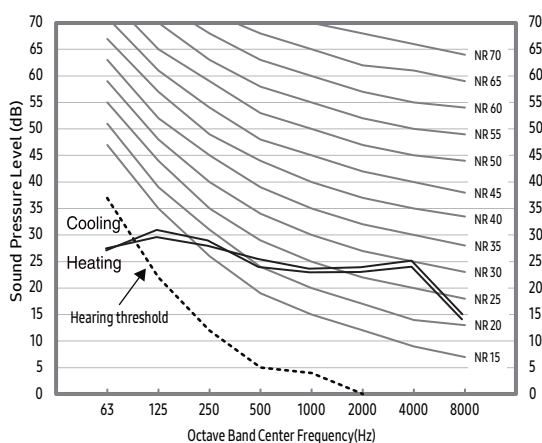

9 Hydraulic performance

Hydro Unit HE

1) AM160FNBDEH***

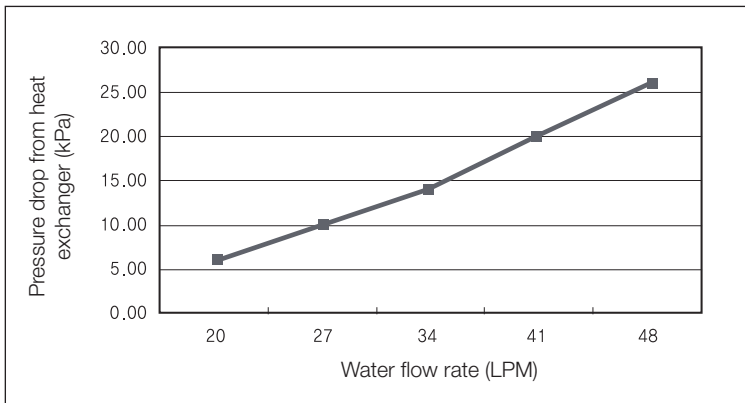

Water flow rate (LPM)	Pressure drop from heat exchanger (kPa)
20	6
27	10
34	14
41	20
48	26

2) AM320FNBDEH***

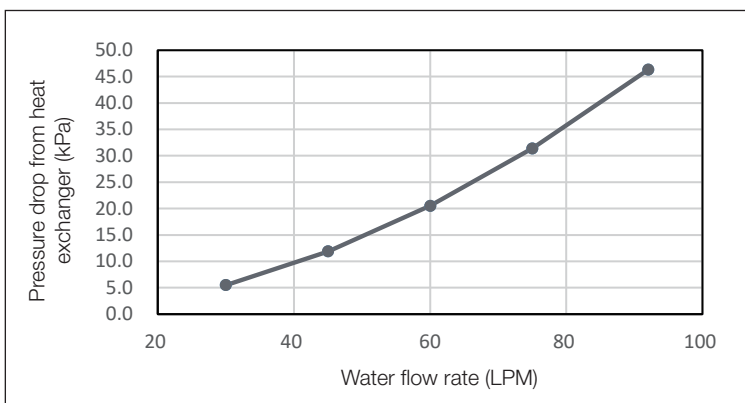

Water flow rate (LPM)	Pressure drop from heat exchanger (kPa)
30	5
45	12
60	21
75	31
92	46

3) AM500FNBDEH***

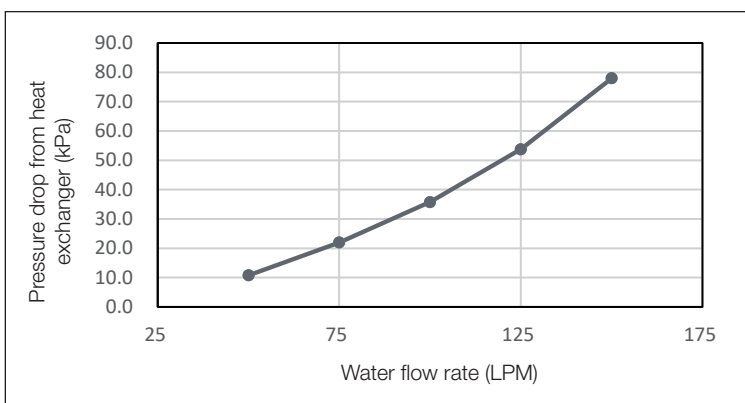

Water flow rate (LPM)	Pressure drop from heat exchanger (kPa)
50	11
75	22
100	36
125	54
150	78

Hydro Unit HT

- 1 *Specifications*
- 2 *Capacity Table*
- 3 *Piping Diagram*
- 4 *Dimensional Drawing*
- 5 *Electrical Wiring Diagram*
- 6 *Sound Pressure Level*
- 7 *Hydraulic Performance*

1 Specifications

Hydro Unit HT

1) Technical specifications

Model				AM160FNBFB***	AM160FNBFBG***	AM250FNBFB***	AM250FNBFBG***
Power Supply			Ø, #, V, Hz	1, 2, 220-240, 50	3, 4, 380-415, 50	1, 2, 220-240, 50	3, 4, 380-415, 50
Mode			-	HP/HR	HP/HR	HP/HR	HP/HR
Performance	Capacity (Nominal)	Cooling *1)	kW	-	-	-	-
			Btu/h	-	-	-	-
		Heating *2)	kW	16.0	16.0	25.0	25.0
			Btu/h	54,600	54,600	85,300	85,300
Power	Power Input (Nominal)	Cooling *1)	W	-	-	-	-
		Heating *2)	W	3,100	3,100	5,000	5,000
	Current Input (Nominal)	Cooling *1)	A	-	-	-	-
		Heating *2)	A	14.3	4.85	23.1	7.85
	MCA (Including External Contact)				24.15	12.88	32.15
MFA			A	30.19	16.1	40.19	16.1
Compressor	Type		-	Rotary	Rotary	Rotary	Rotary
	Output		kW × n	-	-	-	-
	Model Name		-	UX5T250FNBEX	UX5T250FNBEX	UX5T250FNBEX	UX5T250FNBEX
	Oil	Type	-	POE	POE	POE	POE
Initial Charge		cc	1,700	1,700	1,700	1,700	
Heat Exchanger	Type		-	PHE	PHE	PHE	PHE
	Quantity		-	2	2	2	2
	Pipe Size		Ø, inch	PT 1 (25A)	PT 1 (25A)	PT 1 (25A)	PT 1 (25A)
	Water Flow Rate		LPM	23	23	36	36
	Flow Switch		LPM	12	12	12	12
Option Code			-	01104C-105000-20A0A0-332200	01104C-105000-20A0A0-332200	01104C-105000-20FAFA-332100	01104C-105000-20FAFA-332100
Piping Connections	Liquid Pipe	Ø, mm	9.52	9.52	9.52	9.52	
		Ø, inch	3/8"	3/8"	3/8"	3/8"	
	Gas Pipe	Ø, mm	15.88	15.88	15.88	15.88	
		Ø, inch	5/8"	5/8"	5/8"	5/8"	
Drain Pipe		Ø, mm	-	-	-	-	
Field Wiring	Power Source Wire (L<10m, Single Installation)		mm2	4.0	2.5	4.0	2.5
	Transmission Cable		mm2	0.75 ~ 1.5	0.75 ~ 1.5	0.75 ~ 1.5	0.75 ~ 1.5
Refrigerant	Type		-	R-134a	R-134a	R-134a	R-134a
	Control Method		-	EEV	EEV	EEV	EEV
	Factory Charging		kg / tCO ₂ e	2.15 / 3.07	2.15 / 3.07	2.15 / 3.07	2.15 / 3.07
Sound	Sound Pressure *3)			42	42	42	42
	Sound Power			-	-	-	-
Dimensions	Net Weight		kg	104.00	104.00	104.00	104.00
	Shipping Weight		kg	107	107	107	107
	Net Dimensions (W×H×D)		mm	518 x 1,210 x 330	518 x 1,210 x 330	518 x 1,210 x 330	518 x 1,210 x 330
	Shipping Dimensions (W×H×D)		mm	652 x 1,289 x 426	652 x 1,289 x 426	652 x 1,289 x 426	652 x 1,289 x 426
Operating Temp. Range	Ambient	Cooling	°C	-	-	-	-
		Heating	°C	-20 ~ 35	-20 ~ 35	-20 ~ 35	-20 ~ 35
		Hot Water (Main Cooling, HR)	°C	-20.0 ~ 35(43)	-20.0 ~ 35(43)	-20.0 ~ 35(43)	-20.0 ~ 35(43)
	Leaving Water	Cooling	°C	-	-	-	-
		Heating	°C	25.0 ~ 80.0	25.0 ~ 80.0	25.0 ~ 80.0	25.0 ~ 80.0

* * Specifications may be subject to change without prior notice for product improvement.

- *1) Nominal cooling capacities are based on;
 - Water temperature : 23°C inlet, 18°C outlet
 - Indoor temperature : 27°C DB, 19°C WB
 - Outdoor temperature : 35°C DB, 24°C WB

- *2) Nominal heating capacities are based on;
 - Water temperature : 55°C inlet, 65°C outlet
 - Indoor temperature : 20°C DB
 - Outdoor temperature : 7°C DB, 6°C WB

- *3) Sound pressure was acquired in an anechoic room. Thus actual noise level may be different depending on the installation conditions.

- *4) These products contain R410A which is fluorinated greenhouse gas.

* Heat Exchanger type : Plate Heat Exchanger (STS)

- *5) These products contain R134a(GWP=1,430) which is fluorinated greenhouse gas.

2 Capacity table

Hydro Unit HT

1) Heating

HC : Heating Capacity(W), PI : Power Input(W)
LW : Leaving Water temperature, EW : Entering Water temperature

Model	Ta [°C DB]	LW[°C]		LW[°C]		LW[°C]		LW[°C]	
		45		55		65		75	
		HC	PI	HC	PI	HC	PI	HC	PI
160	-20	15,000	2,062	15,000	2,017	15,000	2,523	14,000	3,193
	-17	15,000	2,083	15,000	1,952	15,000	2,357	14,500	3,063
	-15	15,500	2,313	15,500	2,007	15,500	2,435	15,000	2,895
	-7	15,500	2,305	16,000	2,185	16,000	2,598	15,500	2,956
	-3	16,000	2,352	16,000	2,380	16,000	2,560	16,000	3,087
	1	16,000	2,146	16,000	2,363	16,000	2,501	16,000	3,052
	3	16,000	2,041	16,000	2,314	16,000	2,453	16,000	2,963
	7	16,000	1,868	16,000	2,281	16,000	2,419	16,000	2,828
	11	16,000	1,850	16,000	2,279	16,000	2,428	16,000	2,763
	15	16,000	1,806	16,000	2,259	16,000	2,474	16,000	2,734
	20	16,000	1,784	16,000	2,232	16,000	2,444	16,000	2,701
	25	16,000	1,763	16,000	2,205	16,000	2,415	16,000	2,668
	30	16,000	1,741	16,000	2,178	16,000	2,385	16,000	2,636
	35	16,000	1,719	16,000	2,151	16,000	2,355	16,000	2,603
250	-20	23,000	4,460	23,000	4,734	22,000	5,017	21,500	5,424
	-17	23,500	4,333	23,500	4,563	23,500	4,802	22,500	5,159
	-15	24,000	4,287	24,500	4,456	24,500	4,670	23,500	4,996
	-7	24,500	3,878	25,000	4,084	25,000	4,235	24,000	4,442
	-3	25,000	3,736	25,000	3,933	25,000	4,073	24,500	4,226
	1	25,000	3,616	25,000	3,803	25,000	3,948	25,000	4,051
	3	25,000	3,565	25,000	3,747	25,000	3,900	25,000	3,979
	7	25,000	3,443	25,000	3,652	25,000	3,831	25,000	3,865
	11	25,000	3,417	25,000	3,580	25,000	3,799	25,000	3,791
	15	25,000	3,400	25,000	3,530	25,000	3,798	25,000	3,758
	20	25,000	3,359	25,000	3,488	25,000	3,752	25,000	3,713
	25	25,000	3,318	25,000	3,445	25,000	3,707	25,000	3,668
	30	25,000	3,278	25,000	3,403	25,000	3,661	25,000	3,623
	35	25,000	3,237	25,000	3,360	25,000	3,616	25,000	3,578

EW = 40°C
ΔT = 5°C

EW = 45°C
ΔT = 10°C

EW = 55°C
ΔT = 10°C

EW = 65°C
ΔT = 10°C

Conditions

- ΔT = Leaving Water temperature - Entering Water temperature
- No pump power input is included.
- Equivalent piping length = 7.5m
- Ta < 0 °C : RH=75%, Ta > 0 °C : RH=85%

2 Capacity table

Hydro Unit HT

2) Capacity calculation method

How to calculate heating capacity and power input : Combination of outdoor unit and hydro unit HT

- Heating capacity and power input of hydro unit HT : refer to the indoor unit capacity table.
- Power input of outdoor unit : refer to the outdoor unit capacity table (indoor 20°C DB).

Example

- Standard condition: Outdoor 7°C DB/6°C WB, Indoor 20°C DB
- Water condition: EW 55°C, LW 65°C

8HP DVM S TDB Heat Capacity Table

combination, % (Capacity index)	Outdoor Temperature(°C)		Indoor Temperature (°C,DB)	
			20.0 °C	
	DB	WB	TC kW	PI kW
100%	-20	-21	19.8	7.80
	-17	-18	20.9	7.96
	-15	-16	22.0	8.04
	-12	-13	22.9	7.92
	-10	-11	23.9	7.68
	-7	-8	24.4	7.21
	-5	-6	25.2	6.84
	-3	-4	25.2	6.21
	0	-1	25.2	5.84
	3	2	25.2	5.52
	5	4	25.2	5.23
	7	6	25.2	5.10
	9	8	25.2	4.85
	11	10	25.2	4.63
	13	12	25.2	4.42
15	14	25.2	4.27	

Combination 1 (Outdoor Unit 8HP + Indoor Unit 8HP)

Indoor Heat Capa.[kW]	25	= HT Capacity Table
PI Indoor Unit(8HP)[kW]	3.831	= HT Capacity Table
PI Outdoor Unit(8HP)[kW]	5.10	----- Outdoor Unit Capacity Table
PI System[kW]	8.93	=Indoor Unit PI + Outdoor Unit PI

2 Capacity table

Hydro Unit HT

10HP DVM S TDB Heat Capacity Table

combination, % (Capacity index)	Outdoor Temperature(°C)		Indoor Temperature (°C,DB)	
			20.0 °C	
	DB	WB	TC kW	PI kW
100%	-20	-21	26.5	10.24
	-17	-18	28.1	10.45
	-15	-16	29.1	10.67
	-12	-13	29.7	10.62
	-10	-11	30.7	10.40
	-7	-8	31.2	9.57
	-5	-6	31.5	8.99
	-3	-4	31.5	8.15
	0	-1	31.5	7.68
	3	2	31.5	7.25
	5	4	31.5	6.88
	7	6	31.5	6.70
	9	8	31.5	6.38
	11	10	31.5	6.08
	13	12	31.5	5.81
15	14	31.5	5.61	

Combination 1 (Outdoor Unit 10HP + Indoor Unit 5HP x 2ea)

Indoor Heat Capa.[kW]	16	= HT Capacity Table
Indoor Heat Capa.[kW]	32	= 2 x 5HP
PI Indoor Unit(5HP)[kW]	2.419	= HT Capacity Table
PI Total Indoor Unit[kW]	4.838	= 2 x 5HP
PI Outdoor Unit(10HP)[kW]	6.70	----- Outdoor Unit Capacity Table
PI System[kW]	11.54	= Total Indoor Unit PI + Outdoor Unit PI

Flowrate Information

Flowrate[l/min]	**160**	**250**
ΔT = 15°C	15.4	24.1
ΔT = 10°C	23.0	36.0
ΔT = 5°C	46.0	72.0

2 Capacity table

Hydro Unit HT

How to calculate heating capacity and power input : Integrated value

1. Defrosting correction factor (Outdoor unit)

- On heating operation, frost can be formed on heat exchanger according to outdoor temperature. (Frost on heat exchanger results in decreasing the performance.)
To remove frost on heat exchanger of outdoor unit, defrost operation is carried out periodically.
During defrost operation, capacity of outdoor unit may decrease.
The decrement is not considered to the individual capacity tables.

Outdoor temperature (°C, DB)	-10	-8	-6	-4	-2	0	3	5	7
Capacity coefficient	0.98	0.97	0.95	0.93	0.88	0.85	0.86	0.91	1

Corrected Heating Capacity = heating capacity x Capacity coefficient

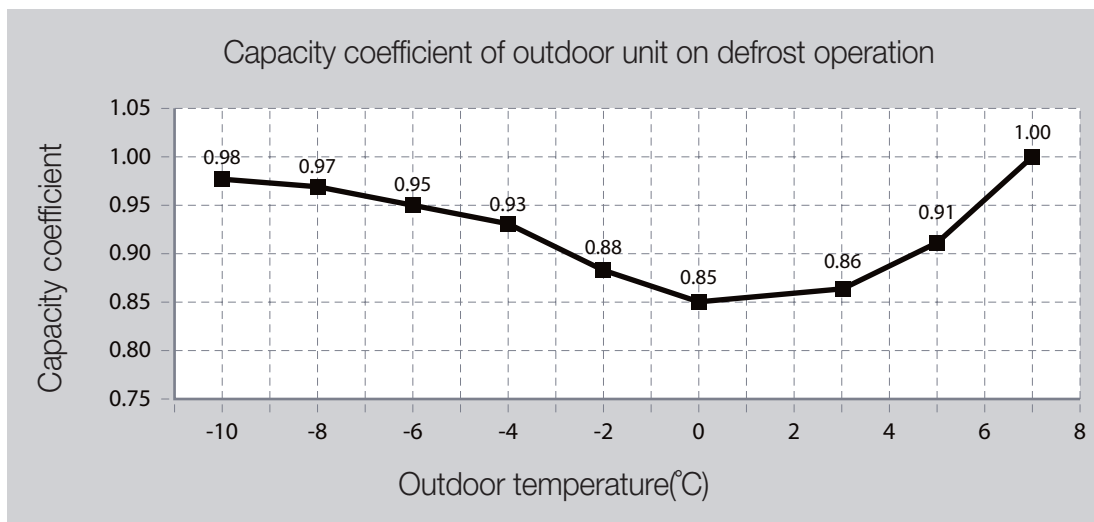

2. Power input of hydro unit HT during defrost operation

	Power Input (W)
HT 5HP	1050
HT 8HP	1500

3. Capacity correction factor of hydro unit HT during defrost operation

	HT Capa Correction Factor
HT 5HP	0.3
HT 8HP	

2 Capacity table

Hydro Unit HT

Example) Combination: 10HP DVM S + 5HP HT X 2ea, Outdoor 5°C DB, EW/LW=55°C/65°C

- 1) Defrosting correction factor (Outdoor unit, 5°C) = 0.91
- 2) Capacity correction factor (Hydro unit HT) = 0.3
- 3) Integrated capacity correction factor = $0.91 - (1 - 0.91) \times 0.3 = 0.883$
- 4) HC = $0.883 \times 16,000W \times 2ea = 28.3kW$
- 5) Power input (Outdoor unit) = 6.88kW
- 6) Power input (Hydro unit HT) = $\{ 0.91 \times (2,453W + 2,419W) / 2 + (1 - 0.91) \times 1,050W \} \times 2 = 4.62kW$
- 7) Total PI = $6.88 + 4.62 = 11.5kW$

10HP DVM S TDB Heat Capacity Table

combination, % (Capacity index)	Outdoor Temperature(°C)		Indoor Temperature (°C,DB)	
			20.0 °C	
	DB	WB	TC kW	PI kW
100%	-20	-21	26.5	10.24
	-17	-18	28.1	10.45
	-15	-16	29.1	10.67
	-12	-13	29.7	10.62
	-10	-11	30.7	10.40
	-7	-8	31.2	9.57
	-5	-6	31.5	8.99
	-3	-4	31.5	8.15
	0	-1	31.5	7.68
	3	2	31.5	7.25
	5	4	31.5	6.88
	7	6	31.5	6.70
	9	8	31.5	6.38
	11	10	31.5	6.08
13	12	31.5	5.81	
15	14	31.5	5.61	

2-3. Operation range

1) Heating

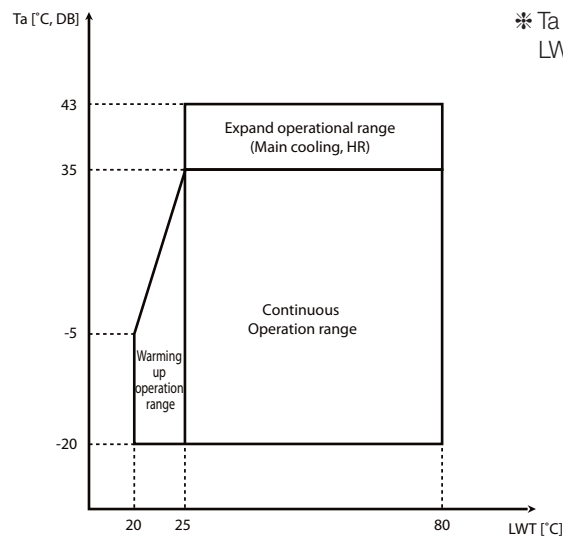

3 Piping diagram

Hydro Unit HT

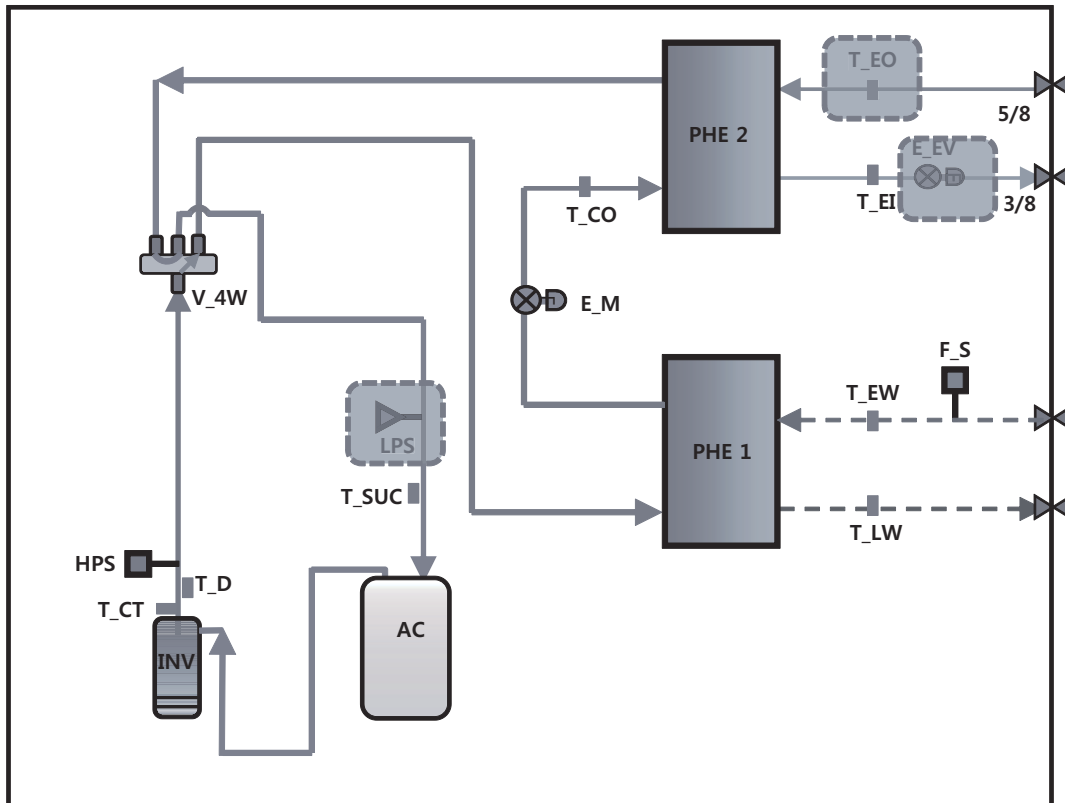

Symbol	Name
INV	Inverter Compressor
PHE1	Plate Heat Exchanger(R134a/water)
PHE2	Plate Heat Exchanger(R134a/R410a)
AC	Accumulator
HPS	High Pressure Sensor
LPS	Low Pressure Sensor
E_M	Main EEV (R134a)
E_EV	EVI EEV (R410a)
V_4W	4Way Valve
T_D	Discharge Temp. Sensor
T_CO	Cond Out Temp. Sensor
T_EI	EVI In Temp. Sensor (R410a)
T_EO	EVI Out Temp. Sensor (R410a)
T_CT	Comp. Top Temp. Sensor
T_SUC	Suction Temp. Sensor
T_EW	Entering Water Temp. Sensor
T_LW	Leaving Water Temp. Sensor
F_S	Flow Switch

4 Dimensional drawing

Hydro Unit HT

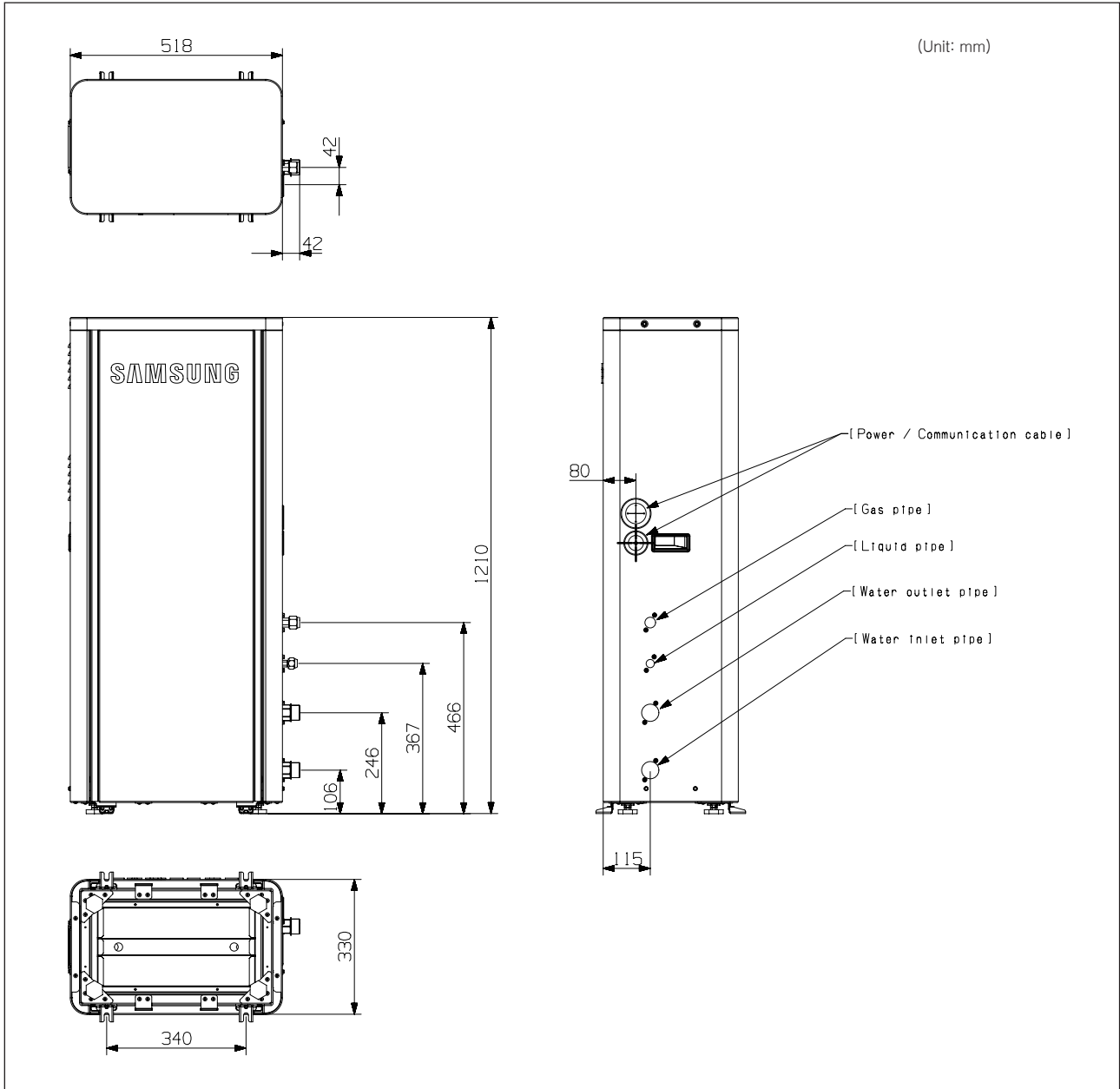

Model of the Hydro unit		AM***FNBF*B
Refrigerant side	Liquid side connection part	3/8" (ø9.52)
	Gas side connection part	5/8" (ø15.88)
Water side connection part		PT 1(25A)

5 Electrical Wiring Diagram

Hydro Unit HT

AM160/250FNBFE/BU

에러코드 Error No	PBA - 에러 설명 Error Description	에러 원인 Faulted part	동작 상태/점검 사항 Operation status/Inspection checklist	비고 Remarks
E 1 1 0	Control Kit PBA - MAIN PBA 간 통신 단절 에러 (Control Kit에러 전파) Communication error between the control kit and main	DB - B2 통신 케이블 COMMUNICATION CABLE	통신 케이블 연결 상태 점검 Check cable connection status of the control panel on the site	에러 전파 Optional
E 1 2 1	Room 센서의 Short 또는 Open Room sensor error (Short/Short)	DB - B4 방열기 ROOM	방열기 작동 상태 점검 Check on/off status for room lamp of the panel on the site	에러 전파 Optional
E 1 2 2	Line in 센서의 Short 또는 Open Line in sensor error (Short/Short)	DB - B6 방열기 LINE IN PUMP	방열기 작동 상태 점검 Check the status of the pump operation signal and on/off status of operation at the control panel on the site	에러 전파 Optional
E 1 2 3	Line out 센서의 Short 또는 Open Line out sensor error (Short/Short)	DB - B8 보일러 제어 HEATER	보일러 작동 상태 점검 Check the status of the boiler operation signal output at the control panel on the site	에러 전파 Optional
E 1 9 8	Thermal fuse cut off error 화재 차단기 - 열점기 차단 에러 (화재 차단기 / 열점기 차단) Communication error (The mismatched number of hydro unit)	DB - B08 - B11 SW1 1 SW2 1 VV	SW1, SW2 작동 상태 점검 Check the status of signal output and on/off status of valve operation (Direction of flow of the heater hot water line)	에러 전파 Optional
E 2 0 1	화재 차단기 - 열점기 차단 에러 (화재 차단기 / 열점기 차단) Communication error between the outdoor and hydro unit	DB1 - B31 - B31 SW1 1 VV SW2 2 VV	SW1, SW2 작동 상태 점검 Check the status of signal output and on/off status of valve operation (Water locked in the outdoor pump signal)	에러 전파 Optional
E 2 0 2	화재 차단기 - 열점기 차단 에러 (화재 차단기 / 열점기 차단) Hydro unit communication error between main micron and in, micron	DB5 - B16 - B17 SW1 1 VV SW2 1 VV	SW1, SW2 작동 상태 점검 Check the status of signal output and operation status of the valve	에러 전파 Optional
E 2 2 1	실외기 온도 센서 Short 또는 Open Outdoor air temperature sensor error (Short/Short)	DB9 - B30 AC20, AC20-25A AC20, HEATSENSIT	실외기 온도 센서 작동 상태 점검 Check the connection status of the thermostat and operation status of the product (cooling)	에러 전파 Optional
E 2 3 1	Condenser outlet sensor error (Open/Short)			
E 2 5 1	Compressor discharge temperature sensor error (Open/Short)			
E 2 9 1	고압 센서 Short 또는 Open High pressure sensor error (Short or Open)			
E 2 9 6	저압 센서 Short 또는 Open Low pressure sensor error (Short or Open)			
E 3 0 8	Section 센서 Short 또는 Open (비정상 - 센서 동작) Section temperature sensor error (Short/Short)			
E 3 2 0	실외기 온도 센서 Short 또는 Open Outdoor air temperature sensor error (Short/Short)			
E 4 0 7	고압 과부하 에러 High pressure error			
E 4 1 0	Compressor operation stop due to low pressure protection control or refrigerant leakage 디شار지 온도 에러 (High pressure error)			
E 4 1 6	디شار지 온도 에러 (High pressure error)			
E 4 2 8	Compressor operation stop due to abnormal compression ratio 실외기 과부하 에러			
E 4 3 9	실외기 과부하 에러 Error due to the refrigerant leakage			
E 4 4 0	실외기 과부하 에러 (High pressure error)			
E 4 4 3	실외기 과부하 에러 (High pressure error)			
E 4 6 1	Compressor relation error Compressor relation error			
E 4 6 2	실외기 과부하 에러 (High pressure error)			
E 4 6 3	실외기 과부하 에러 (High pressure error)			
E 4 6 4	실외기 과부하 에러 (High pressure error)			
E 4 6 5	실외기 과부하 에러 (High pressure error)			
E 4 6 6	실외기 과부하 에러 (High pressure error)			
E 4 6 7	실외기 과부하 에러 (High pressure error)			
E 4 6 8	실외기 과부하 에러 (High pressure error)			
E 4 6 9	실외기 과부하 에러 (High pressure error)			
E 4 7 0	실외기 과부하 에러 (High pressure error)			
E 4 7 1	실외기 과부하 에러 (High pressure error)			
E 4 7 2	실외기 과부하 에러 (High pressure error)			
E 4 7 3	실외기 과부하 에러 (High pressure error)			
E 4 7 4	실외기 과부하 에러 (High pressure error)			
E 4 8 4	실외기 과부하 에러 (High pressure error)			
E 4 8 5	실외기 과부하 에러 (High pressure error)			
E 5 0 0	실외기 과부하 에러 (High pressure error)			
E 9 0 1	Water inlet (PIE) temperature sensor error (Short/Short)			
E 9 0 2	Water outlet (PIE) temperature sensor error (Short/Short)			
E 9 0 4	Water tank water sensor error (Short/Short)			
E 9 0 7	Error due to pipe rupture protection			
E 9 0 8	동결방지 에러 Error due to freeze prevention (operation is possible)			
E 9 0 9	동결방지 중 Com off 동작 에러 (동작이 불가능) Error due to freeze prevention (operation is impossible)			
E 9 1 0	Water temperature sensor on water outlet pipe is detached			
E 9 1 1	Film Switch Error			
E 9 1 2	Film Switch Close Error			
E 9 1 3	Film Switch Error (6회 검사 재검사를 필요) Six times detection for Film Switch Error			
E 9 1 4	Thermalist 오작동 에러 Error due to incorrect thermalist connection			
E 9 1 5	DC Fan Motor feed back error			

하이드로유닛 전기회로도
Wiring Diagram Hydro unit
DB68-04030A

에러 코드
E 9 0 8 Error due to freeze prevention (operation is possible)
E 9 0 9 동결방지 중 Com off 동작 에러 (동작이 불가능)
Error due to freeze prevention (operation is impossible)
E 9 1 0 Water temperature sensor on water outlet pipe is detached
E 9 1 1 Film Switch Error
E 9 1 2 Film Switch Close Error
E 9 1 3 Film Switch Error (6회 검사 재검사를 필요)
Six times detection for Film Switch Error
E 9 1 4 Thermalist 오작동 에러
Error due to incorrect thermalist connection
E 9 1 5 DC Fan Motor feed back error

NOTE

- This wiring diagram applies only to the indoor unit.
- Symbols show as follow;
BLK : black, RED : red, BLU : blue, WHT:white, YEL : yellow, BRN : brown, SKY : sky-blue, GRN : green
- For connection wiring indoor-outdoor transmission F1-F2, indoor-wired remotecontroller transmission F3-F4.
- ⊕: Protective earth(screw), □: Connector, n: The wire quantity

5 Electrical Wiring Diagram

Hydro Unit HT

AM160/250FNBFGB/EU

에러코드 Error No	PBA - 에러 설명 Error Description	에러 번호 Terminal No.	에러 원인 External contact	동작 상태 확인/점검 사항 Operation status/inspection checklist	비고 Remarks
E 1 1 0	Control kit PBA - 메인/외부 PBA 간 통신 단절시 에러 (Control kit/외부 PBA)	B1 - B2	외부 PBA	동작 상태 확인/점검 사항 Operation status/inspection checklist	비고 Remarks
E 1 2 1	Room sensor error (Open/Short)	B3 - B4	AC250, THERMISTOR 1	방열기 작동 상태 확인 (방열기 작동 여부)	옵션 Optional
E 1 2 2	Live in sensor error (Open/Short)	B5 - B6	AC250, THERMISTOR 1	방열기 작동 상태 확인 (방열기 작동 여부)	옵션 Optional
E 1 2 3	Live Out sensor error (Open/Short)	B7 - B8	AC250, THERMISTOR 1	방열기 작동 상태 확인 (방열기 작동 여부)	옵션 Optional
E 1 9 8	Thermist use cut off error	B9 - B10	AC250, THERMISTOR 1	방열기 작동 상태 확인 (방열기 작동 여부)	옵션 Optional
E 2 0 1	Communication error (The mismatched number of hydro unit)	B11 - B12	AC250, THERMISTOR 1	방열기 작동 상태 확인 (방열기 작동 여부)	옵션 Optional
E 2 0 2	Communication error between the outdoor and hydro unit	B13 - B14	AC250, THERMISTOR 1	방열기 작동 상태 확인 (방열기 작동 여부)	옵션 Optional
E 2 0 3	Hydro unit communication error between main indoor and ter. indoor	B15 - B16	AC250, THERMISTOR 1	방열기 작동 상태 확인 (방열기 작동 여부)	옵션 Optional
E 2 2 1	Indoor air temperature sensor error (Short/Open)	B17 - B18	AC250, THERMISTOR 1	방열기 작동 상태 확인 (방열기 작동 여부)	옵션 Optional
E 2 3 1	Condenser outlet sensor error (Open/Short)	B19 - B20	AC250, THERMISTOR 1	방열기 작동 상태 확인 (방열기 작동 여부)	옵션 Optional
E 2 5 1	Compressor discharge temperature sensor error (Open/Short)	B21 - B22	AC250, THERMISTOR 1	방열기 작동 상태 확인 (방열기 작동 여부)	옵션 Optional
E 2 9 1	Refrigerant leakage or error on high pressure sensor (Short or Open)	B23 - B24	AC250, THERMISTOR 1	방열기 작동 상태 확인 (방열기 작동 여부)	옵션 Optional
E 2 9 6	Refrigerant leakage or error on low pressure sensor (Short or Open)	B25 - B26	AC250, THERMISTOR 1	방열기 작동 상태 확인 (방열기 작동 여부)	옵션 Optional
E 3 0 8	Section pressure sensor error (Open/Short)	B27 - B28	AC250, THERMISTOR 1	방열기 작동 상태 확인 (방열기 작동 여부)	옵션 Optional
E 3 2 0	Top of compressor temperature sensor error (Short/Open)	B29 - B30	AC250, THERMISTOR 1	방열기 작동 상태 확인 (방열기 작동 여부)	옵션 Optional
E 4 1 0	Compressor operation stop due to low pressure protection control or refrigerant leakage	B31 - B32	AC250, THERMISTOR 1	방열기 작동 상태 확인 (방열기 작동 여부)	옵션 Optional
E 4 1 6	Discharge over temperature error when compressor stop	B33 - B34	AC250, THERMISTOR 1	방열기 작동 상태 확인 (방열기 작동 여부)	옵션 Optional
E 4 2 8	Compressor stop due to abnormal compression ratio	B35 - B36	AC250, THERMISTOR 1	방열기 작동 상태 확인 (방열기 작동 여부)	옵션 Optional
E 4 3 9	Error due to refrigerant leakage	B37 - B38	AC250, THERMISTOR 1	방열기 작동 상태 확인 (방열기 작동 여부)	옵션 Optional
E 4 4 3	Operation prohibition due to low pressure	B39 - B40	AC250, THERMISTOR 1	방열기 작동 상태 확인 (방열기 작동 여부)	옵션 Optional
E 4 6 1	Comp relation starting error	B41 - B42	AC250, THERMISTOR 1	방열기 작동 상태 확인 (방열기 작동 여부)	옵션 Optional
E 4 6 2	Total input current over load error	B43 - B44	AC250, THERMISTOR 1	방열기 작동 상태 확인 (방열기 작동 여부)	옵션 Optional
E 4 6 3	Top of compressor temperature over heat	B45 - B46	AC250, THERMISTOR 1	방열기 작동 상태 확인 (방열기 작동 여부)	옵션 Optional
E 4 6 4	PIV over current error	B47 - B48	AC250, THERMISTOR 1	방열기 작동 상태 확인 (방열기 작동 여부)	옵션 Optional
E 4 6 5	COMP over load error	B49 - B50	AC250, THERMISTOR 1	방열기 작동 상태 확인 (방열기 작동 여부)	옵션 Optional
E 4 6 6	DC Link voltage sensor error	B51 - B52	AC250, THERMISTOR 1	방열기 작동 상태 확인 (방열기 작동 여부)	옵션 Optional
E 4 6 7	Comp relation error	B53 - B54	AC250, THERMISTOR 1	방열기 작동 상태 확인 (방열기 작동 여부)	옵션 Optional
E 4 6 8	Current sensor error	B55 - B56	AC250, THERMISTOR 1	방열기 작동 상태 확인 (방열기 작동 여부)	옵션 Optional
E 4 6 9	DC Link voltage sensor error	B57 - B58	AC250, THERMISTOR 1	방열기 작동 상태 확인 (방열기 작동 여부)	옵션 Optional
E 4 7 0	EEPROM read/write error	B59 - B60	AC250, THERMISTOR 1	방열기 작동 상태 확인 (방열기 작동 여부)	옵션 Optional
E 4 7 1	EEPROM error	B61 - B62	AC250, THERMISTOR 1	방열기 작동 상태 확인 (방열기 작동 여부)	옵션 Optional
E 4 7 2	Zero crossing error	B63 - B64	AC250, THERMISTOR 1	방열기 작동 상태 확인 (방열기 작동 여부)	옵션 Optional
E 4 7 3	Comp locking error	B65 - B66	AC250, THERMISTOR 1	방열기 작동 상태 확인 (방열기 작동 여부)	옵션 Optional
E 4 7 4	Refrigerant sensor error (Short/Open)	B67 - B68	AC250, THERMISTOR 1	방열기 작동 상태 확인 (방열기 작동 여부)	옵션 Optional
E 4 8 4	PTC over load error	B69 - B70	AC250, THERMISTOR 1	방열기 작동 상태 확인 (방열기 작동 여부)	옵션 Optional
E 4 8 5	Input current sensor error	B71 - B72	AC250, THERMISTOR 1	방열기 작동 상태 확인 (방열기 작동 여부)	옵션 Optional
E 5 0 0	Refrigerant over heat error	B73 - B74	AC250, THERMISTOR 1	방열기 작동 상태 확인 (방열기 작동 여부)	옵션 Optional
E 9 0 1	Water inlet (PIE) temperature sensor error (Short/Open)	B75 - B76	AC250, THERMISTOR 1	방열기 작동 상태 확인 (방열기 작동 여부)	옵션 Optional
E 9 0 2	Water outlet (PIE) temperature sensor error (Short/Open)	B77 - B78	AC250, THERMISTOR 1	방열기 작동 상태 확인 (방열기 작동 여부)	옵션 Optional
E 9 0 4	Water unit Water leak sensor error (Short/Open)	B79 - B80	AC250, THERMISTOR 1	방열기 작동 상태 확인 (방열기 작동 여부)	옵션 Optional
E 9 0 7	Error due to pipe rupture protection	B81 - B82	AC250, THERMISTOR 1	방열기 작동 상태 확인 (방열기 작동 여부)	옵션 Optional
E 9 0 8	Error due to freeze prevention-operation is impossible	B83 - B84	AC250, THERMISTOR 1	방열기 작동 상태 확인 (방열기 작동 여부)	옵션 Optional
E 9 0 9	Error due to freeze prevention-operation is impossible	B85 - B86	AC250, THERMISTOR 1	방열기 작동 상태 확인 (방열기 작동 여부)	옵션 Optional
E 9 1 0	Water temperature sensor on water outlet pipe is detached	B87 - B88	AC250, THERMISTOR 1	방열기 작동 상태 확인 (방열기 작동 여부)	옵션 Optional
E 9 1 1	Film Switch Open	B89 - B90	AC250, THERMISTOR 1	방열기 작동 상태 확인 (방열기 작동 여부)	옵션 Optional
E 9 1 2	Film Switch Close	B91 - B92	AC250, THERMISTOR 1	방열기 작동 상태 확인 (방열기 작동 여부)	옵션 Optional
E 9 1 3	Film Switch Error (방열기 제빙기 작동)	B93 - B94	AC250, THERMISTOR 1	방열기 작동 상태 확인 (방열기 작동 여부)	옵션 Optional
E 9 1 4	Thermistor connection error	B95 - B96	AC250, THERMISTOR 1	방열기 작동 상태 확인 (방열기 작동 여부)	옵션 Optional
E 9 1 5	DC FAN Motor feed back error	B97 - B98	AC250, THERMISTOR 1	방열기 작동 상태 확인 (방열기 작동 여부)	옵션 Optional

E-PASS
하이드로 유닛 전기회로도
Wiring Diagram Hydro unit
DB68-04031A

NOTE

- This wiring diagram applies only to the indoor unit.
- Symbols show as follow;
BLK : black, RED : red, BLU : blue, WHT:white, YEL : yellow, BRN : brown, SKY : sky-blue, GRN : green
- For connection wiring indoor-outdoor transmission F1-F2, indoor-wired remotecontroller transmission F3-F4.
- ⊕: Protective earth(screw), □: Connector, n: The wire quantity

6 Sound pressure level

Hydro Unit HT

1) Operation Sound Level

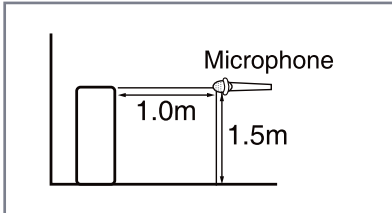

Unit : dB(A)

Model	Heating
AM160FNBFEB ***	42
AM160FNBFGB ***	42
AM250FNBFEB ***	42
AM250FNBFGB ***	42

Note

Specifications may be subject to change without prior notice.
 Sound pressure level is obtained in an anechoic room.
 Sound pressure level is a relative value, depending on the distance and acoustic environment.
 Sound pressure level may differ depending on operation condition.
 dBA = A-weighted sound pressure level
 Reference acoustic pressure 0 dB= 20 uPa

2) NR curve

(1) AM160FNBFEB***

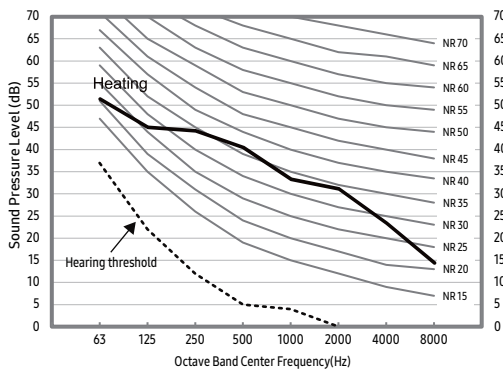

(2) AM250FNBFEB***

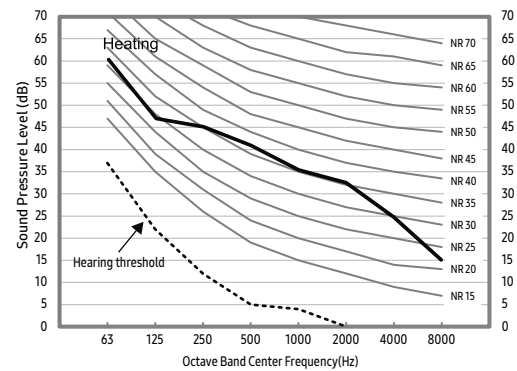

7 Hydraulic performance

Hydro Unit HT

1) AM***FNBF**

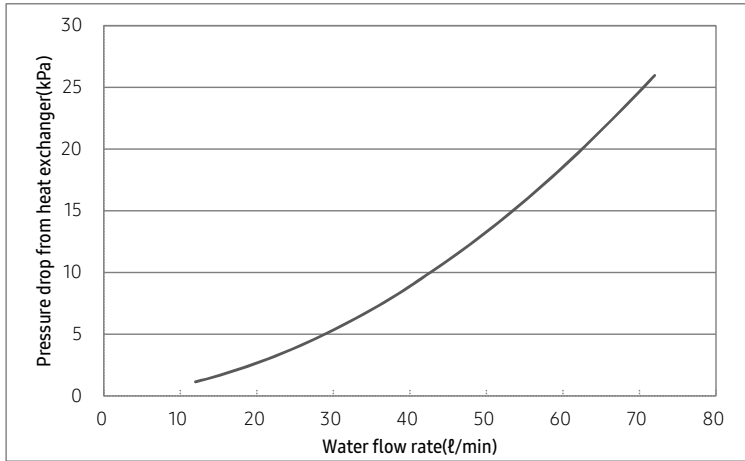

Water flow rate (LPM)	Pressure drop from heat exchanger (kPa)
12	1.1
15	1.6
20	2.7
25	3.9
30	5.3
35	7.0
40	8.9
50	13.3
60	18.5
70	24.6
72	26.0

SAMSUNG

2023.04
Ver. 3.9

Samsung Electronics Co., LTD.

Head Office (Suwon Korea) 129, Samsung-Ro, Yeongtong-Gu, Suwon City, Gyeonggi-Do, Korea 16677
Website : www.samsung.com btsp.samsungsbn.com Email : airconditioner@samsung.com
Images and data in this book may subject to change without prior notice.

SAMSUNG